



**G.P.T CO**  
Gol Pump Technology Company

**DEWATERING PUMPS**  
**HIGH CHROME DEWATERING PUMPS**  
**HEAVY DUTY DEWATERING PUMPS**

50Hz / 60Hz





# TANK SERIES

## HIGH CHROME DEWATERING PUMP

Designed for continuous operations, excellent performance and easy maintenance, GOL PUMP Tank series pumps have proven their reliability and durability in demanding areas like construction, mining, tunneling, quarries, industries and rental applications.

### FEATURES

#### 1 Watertight Cable Entry

The cable entry employs an anti-wicking block where each conductor is stripped and encapsulated in epoxy. This feature effectively prevents water from penetrating the motor chamber when the cable end is submerged or the cable sheath is damaged.

#### 2 Multi-Direction Discharge Coupling

Discharge can be converted between vertical and horizontal directions. In pumps 7.5 HP and larger, a vertical discharge connection is supplied as standard.

#### 3 Motor Protector

The motor incorporates a circle thermal protector which protects against overheating and dry-run.

#### 4 Top Discharge and Double Housing Design

Designed to construct a water jacket that provides maximum motor cooling effect for continuous operation at low water level, this feature forms the cylindrical and slim shape of the pump and enables the pump to be installed in confined spaces.

#### 5 Submersible Motor

Air filled motor, housed in a watertight casing, conforms to Class F insulation.

#### 6 C3 Ball Bearings and Hardened SS Shaft

High quality of C3 ball bearings and the well-balanced, hardened stainless steel shaft enhance stability during continuous pumping operations.

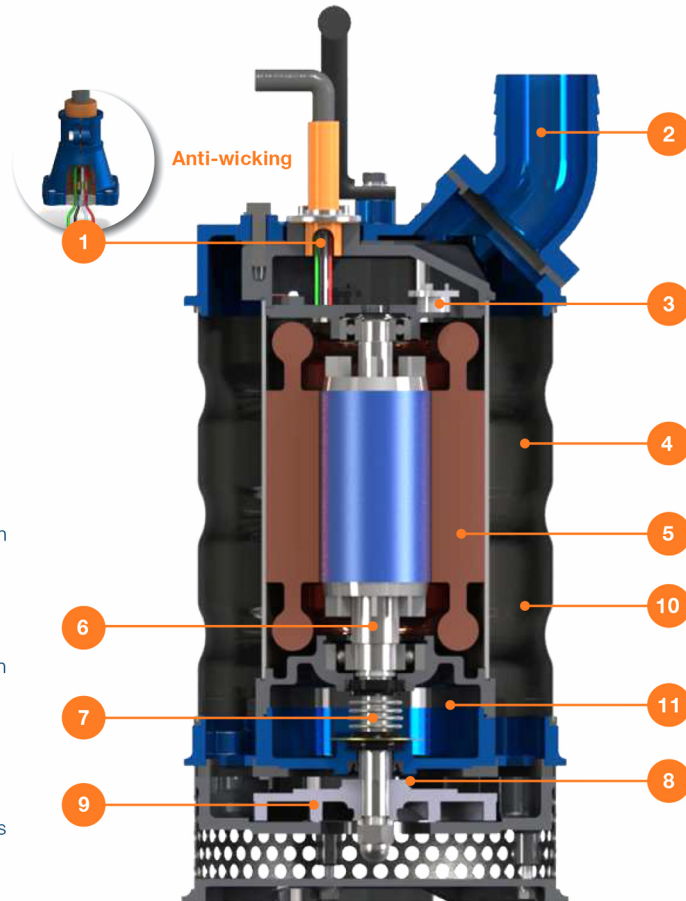

The above images are for illustration purposes only, please refer to datasheets for more details.

#### 7 Double Mechanical Seals

Located in the oil chamber, the device is made of quality materials with highly wear-resistant silicon carbide in lower side that provides extra protection against leakage and dry-run.

#### 8 Extra Protection for Mechanical Seals and Shaft

Lip seals and shaft sleeves are utilized for additional protection against wear.

#### 9 High Chrome Iron Impeller

GOL PUMP patent formula, ACrS Tech is applied to all high chrome iron impellers. This technology increases wear resistance to particle abrasion.

#### 10 Durable Outer Jacket and Strainer

Corrugated Outer Jacket and strainer made from 304 stainless steel provide impact resistance to harsh handling and conditions. In pumps 7.5 HP and larger, flat 304 stainless steel outer casing is provided as standard.

#### 11 Food Grade Lubricant

GOL PUMP adopts eco-friendly lubricant to minimize environmental impacts.





**TANK**

**355 455**



TANK	355	455
Outlet	3" (80mm)	4" (100mm)
Rated Output	7.5HP (5.5kW)	7.5HP (5.5kW)
Shaft Speed	3450 rpm	3450 rpm
Solid Passage	0.4" (10mm)	0.4" (10mm)
Height	25.8" (656mm)	25.8" (656mm)
Diameter	Ø12" (306mm)	Ø12.6" (320mm)
Weight	132 lbs (60kg)	132 lbs (60kg)

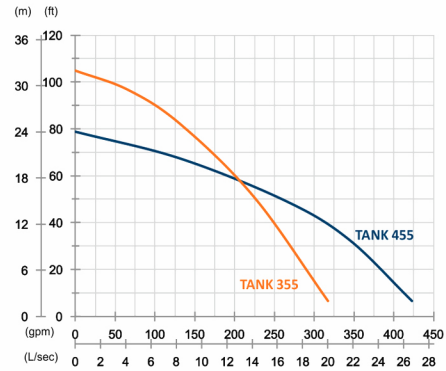

**TANK**

**475 675**



TANK	475	675
Outlet	4" (100mm)	6" (150mm)
Rated Output	10HP (7.5kW)	10HP (7.5kW)
Shaft Speed	3450 rpm	3450 rpm
Solid Passage	0.6" (15mm)	0.6" (15mm)
Height	31.5" (801mm)	32.5" (826mm)
Diameter	Ø12.5" (317mm)	Ø12.5" (317mm)
Weight	205 lbs (93kg)	214 lbs (97kg)

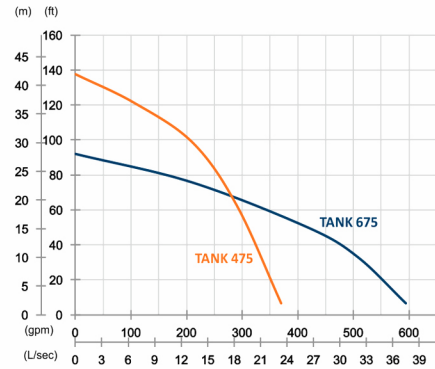

**TANK SLIM**

**380**



TANK SLIM	380
Outlet	3" (80mm)
Rated Output	11HP (8kW)
Shaft Speed	3450 rpm
Solid Passage	0.3" (8mm)
Height	31.4" (798mm)
Diameter	Ø11.1" (283mm)
Weight	203 lbs (92kg)

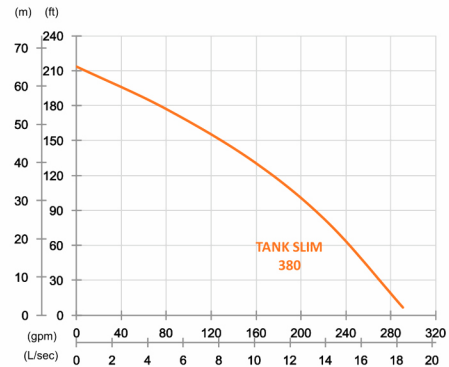

**TANK**

**3110 4110 6110**



TANK	3110	4110	6110
Outlet	3" (80mm)	4" (100mm)	6" (150mm)
Rated Output	15HP (11kW)	15HP (11kW)	15HP (11kW)
Shaft Speed	3450 rpm	3450 rpm	3450 rpm
Solid Passage	0.4" (10mm)	0.4" (10mm)	0.6" (15mm)
Height	34" (863mm)	33.8" (858mm)	34.3" (870mm)
Diameter	Ø13.9" (354mm)	Ø13.9" (354mm)	Ø13.9" (354mm)
Weight	298 lbs (135kg)	298 lbs (135kg)	302 lbs (137kg)

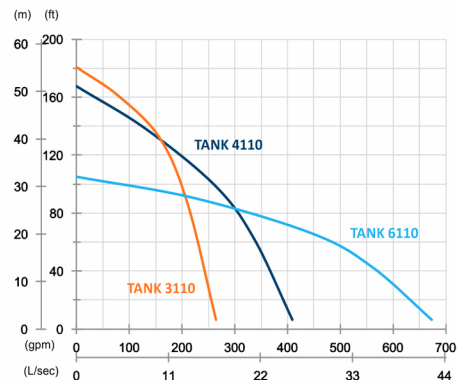



**TANK**

**4150 6150**



TANK	4150	6150
Outlet	4" (100mm)	6" (150mm)
Rated Output	20HP (15kW)	20HP (15kW)
Shaft Speed	3450 rpm	3450 rpm
Solid Passage	0.6" (15mm)	0.6" (15mm)
Height	35" (887mm)	35.4" (899mm)
Diameter	Ø13.9" (354mm)	Ø13.9" (354mm)
Weight	311 lbs (141kg)	313 lbs (142kg)

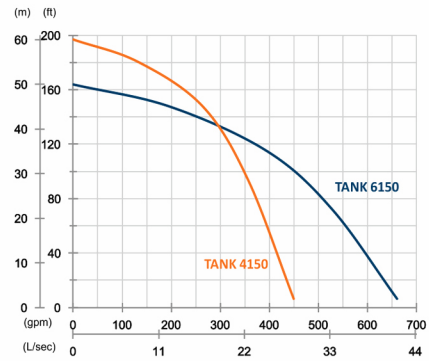

**TANK**

**4220 6220 8220**



TANK	4220	6220	8220
Outlet	4" (100mm)	6" (150mm)	8" (200mm)
Rated Output	30HP (22kW)	30HP (22kW)	30HP (22kW)
Shaft Speed	3450 rpm	3450 rpm	3450 rpm
Solid Passage	0.6" (15mm)	0.8" (20mm)	0.8" (20mm)
Height	42.7" (1085mm)	43.3" (1099mm)	45.4" (1154mm)
Diameter	Ø16.7" (424mm)	Ø16.7" (424mm)	Ø16.7" (424mm)
Weight	564 lbs (256kg)	571 lbs (259kg)	582 lbs (264kg)

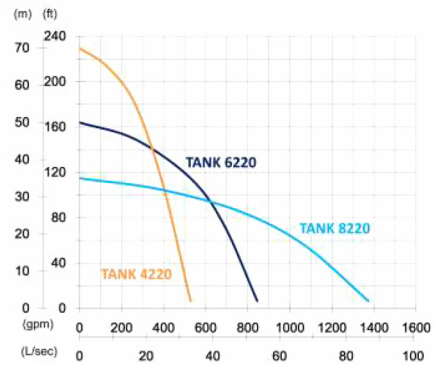

**TANK**

**6370 8370**



TANK	6370	8370
Outlet	6" (150mm)	8" (200mm)
Rated Output	50HP (37kW)	50HP (37kW)
Shaft Speed	3450 rpm	3450 rpm
Solid Passage	0.4" (10mm)	0.8" (20mm)
Height	50.9" (1294mm)	49.4" (1256mm)
Diameter	Ø20.9" (532mm)	Ø20.9" (532mm)
Weight	1124 lbs (510kg)	1124 lbs (510kg)

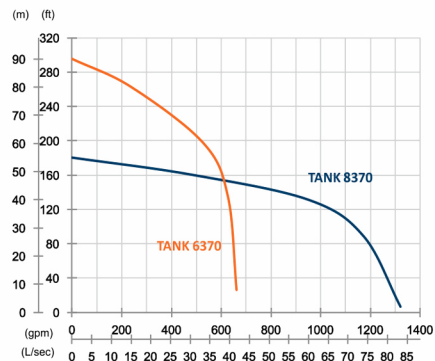

**TANK**

**6450 8450**



TANK	6450	8450
Outlet	6" (150mm)	8" (200mm)
Rated Output	60HP (45kW)	60HP (45kW)
Shaft Speed	3450 rpm	3450 rpm
Solid Passage	0.4" (10 mm)	0.8" (20mm)
Height	50.9" (1294mm)	49.4" (1256mm)
Diameter	Ø20.9" (532mm)	Ø20.9" (532mm)
Weight	1168 lbs (530kg)	1168 lbs (530kg)

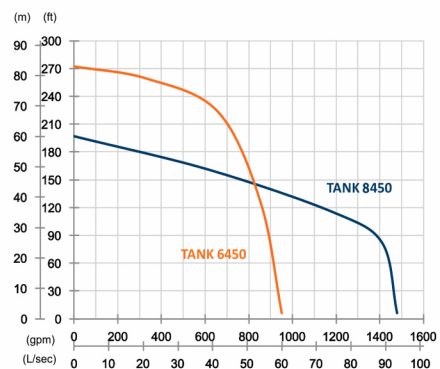



# TITAN SERIES

## HEAVY DUTY DEWATERING PUMP

Rugged, reliable and cost effective, the Titan series pumps deliver excellent performance and serve a wide range of tough dewatering applications like mines, construction site, rental applications and other demanding industries.

### FEATURES

Anti-wicking

#### 1 Watertight Cable Entry

The cable entry employs an anti-wicking block where each conductor is stripped and encapsulated in epoxy. This feature effectively prevents water from penetrating the motor chamber when the cable end is submerged or the cable sheath is damaged.

#### 2 Top Discharge and Side Flow Design

Designed to cool the motor with pumped water even at low water level, this feature forms the cylindrical and slim shape of the pump and enables the pump to be installed in confined spaces.

#### 3 Motor Protector

The motor incorporates a circle thermal protector which protects against overheating and dry-run.

#### 4 Submersible 4-Pole Motor

Air filled motor, housed in a watertight casing, conforms to Class F insulation. The 4-pole motor helps reducing impeller wears.

#### 5 C3 Ball Bearings and Hardened SS Shaft

High quality of C3 ball bearings and the well-balanced, hardened stainless steel shaft enhance stability during continuous pumping operations.

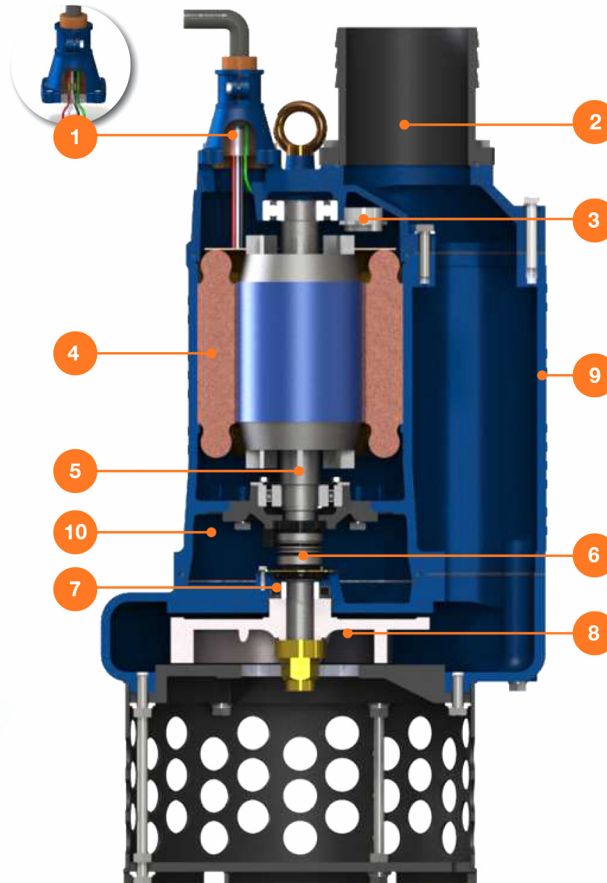

The above images are for illustration purposes only, please refer to datasheets for more details.

#### 6 Double Mechanical Seals

Located in the oil chamber, the device is made of quality materials with highly wear-resistant silicon carbide in lower side that provides extra protection against leakage and dry-run.

#### 7 Extra Protection for Mechanical Seals and Shaft

Lip seals and shaft sleeves are utilized for additional protection against wear.

#### 8 High Chrome Iron Impeller

GOL PUMP patent formula, ACrS Tech is applied to all high chrome iron impellers. This technology increases wear resistance to particle abrasion.

#### 9 Rugged Cast Iron Construction

The whole cast iron pump features a simple, robust structure that provides durability and impact resistance against rough conditions.

#### 10 Food Grade Lubricant

GOL PUMP adopts eco-friendly lubricant to minimize environmental impacts.

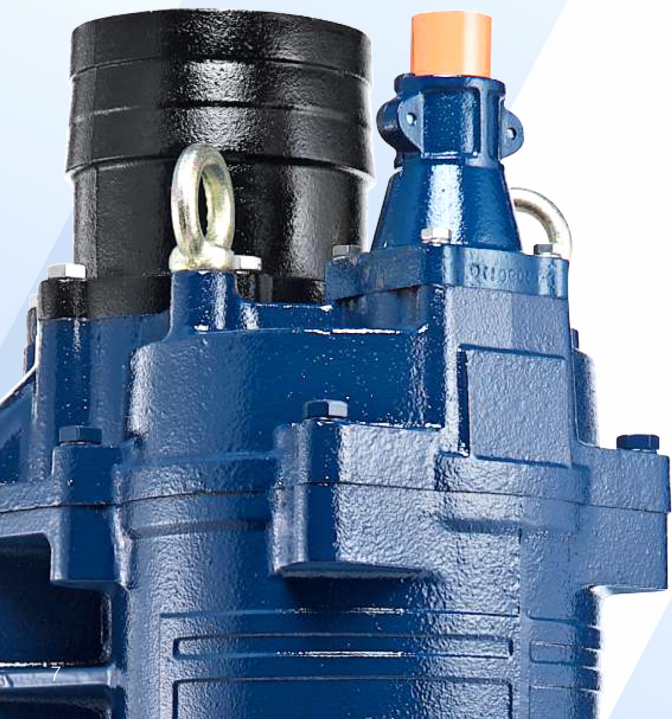



**TITAN**

**337 437**



TITAN	337	437
Outlet	3" (80mm)	4" (100mm)
Rated Output	5HP (3.7kW)	5HP (3.7kW)
Shaft Speed	1750 rpm	1750 rpm
Solid Passage	1" (25mm)	1" (25mm)
Height	31.2" (793mm)	32" (814mm)
Diameter	Ø15" (382mm)	Ø15" (382mm)
Weight	249 lbs (113kg)	249 lbs (113kg)

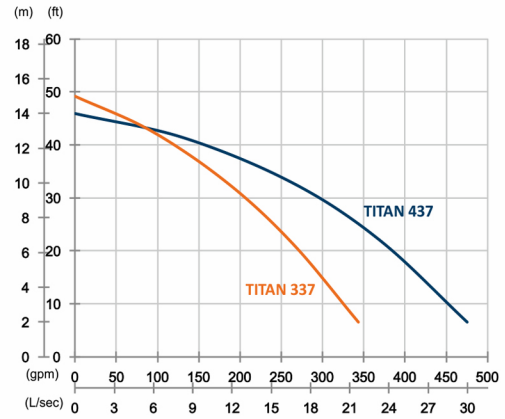

**TITAN**

**355 455 475**



TITAN	355	455	475
Outlet	3" (80mm)	4" (100mm)	4" (100mm)
Rated Output	7.5HP (5.5kW)	7.5HP (5.5kW)	10HP (7.5kW)
Shaft Speed	1750 rpm	1750 rpm	1750 rpm
Solid Passage	1" (25mm)	1" (25mm)	1" (25mm)
Height	31.7" (806mm)	32.5" (826mm)	32.5" (826mm)
Diameter	Ø16.2" (412mm)	Ø16.2" (412mm)	Ø16.2" (412mm)
Weight	282 lbs (128kg)	284 lbs (129kg)	284 lbs (129kg)

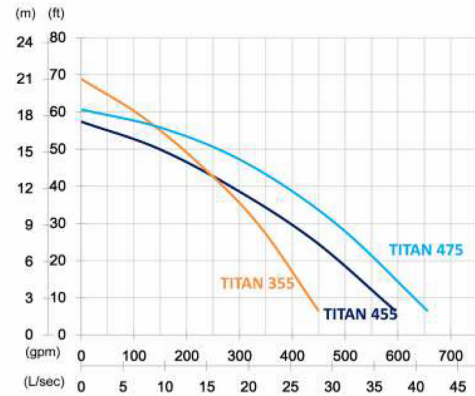

**TITAN**

**4110 6110**



TITAN	4110	6110
Outlet	4" (100mm)	6" (150mm)
Rated Output	15HP (11kW)	15HP (11kW)
Shaft Speed	1750 rpm	1750 rpm
Solid Passage	1" (25mm)	1.4" (35mm)
Height	35.8" (910mm)	36.3" (922mm)
Diameter	Ø18.9" (479mm)	Ø18.9" (479mm)
Weight	430 lbs (195kg)	432 lbs (196kg)

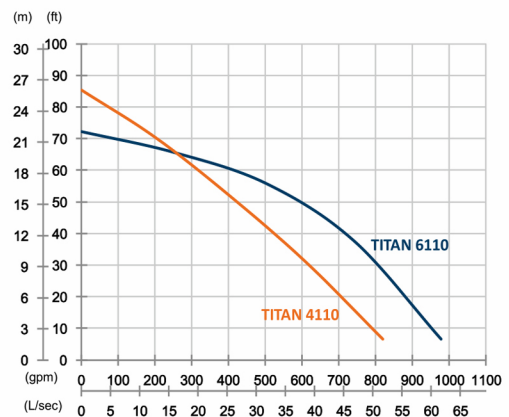



### Advanced Chromium Steel Tech

ACrS Tech is designed for high wear resistance and superb corrosion resistance. This patented technology is applied to all our dewatering and slurry pump family to tackle tough challenging applications. The advantages of ACrS Tech can easily and dramatically reduce operational costs.

## TITAN | 6150 6150L



TITAN	6150	6150L
Outlet	6" (150mm)	6" (150mm)
Rated Output	20HP (15kW)	20HP (15kW)
Shaft Speed	1750 rpm	1750 rpm
Solid Passage	1.4" (35mm)	1.4" (35mm)
Height	36.3" (922mm)	36.3" (922mm)
Diameter	Ø18.9" (479mm)	Ø18.9" (479mm)
Weight	450 lbs (204kg)	452 lbs (205kg)

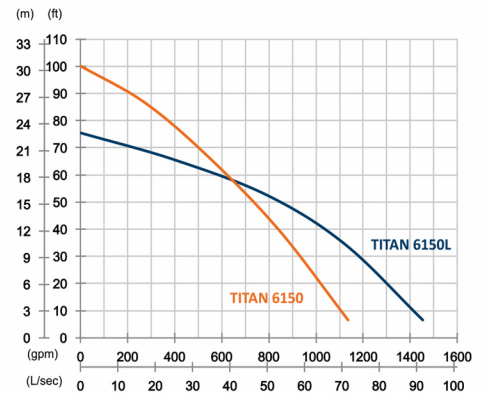

## TITAN | 6220 8220



TITAN	6220	8220
Outlet	6" (150mm)	8" (200mm)
Rated Output	30HP (22kW)	30HP (22kW)
Shaft Speed	1750 rpm	1750 rpm
Solid Passage	1.2" (30mm)	1.4" (35mm)
Height	47.6" (1210mm)	46.1" (1172mm)
Diameter	Ø23.3" (592mm)	Ø23.3" (592mm)
Weight	772 lbs (350kg)	772 lbs (350kg)

