



Technical Data

Multi Stage Pump - GARS-U 80/02

Revision no.

 Page:
1

Receiver

From

 Company name
 Respons. Department
 Person in charge
 Phone number
 Fax no
 E-mail address

--	--

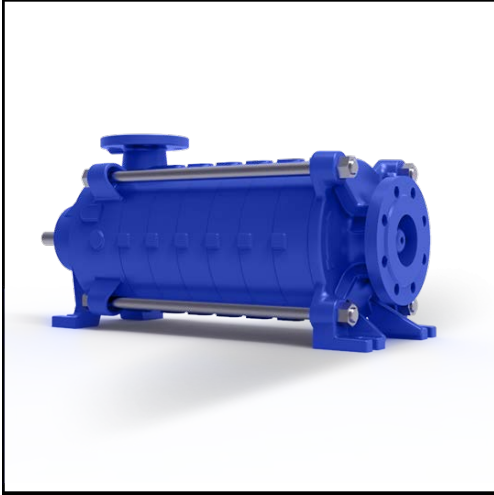

Brand: Gol Pumps
Model: GARS-U 80/02

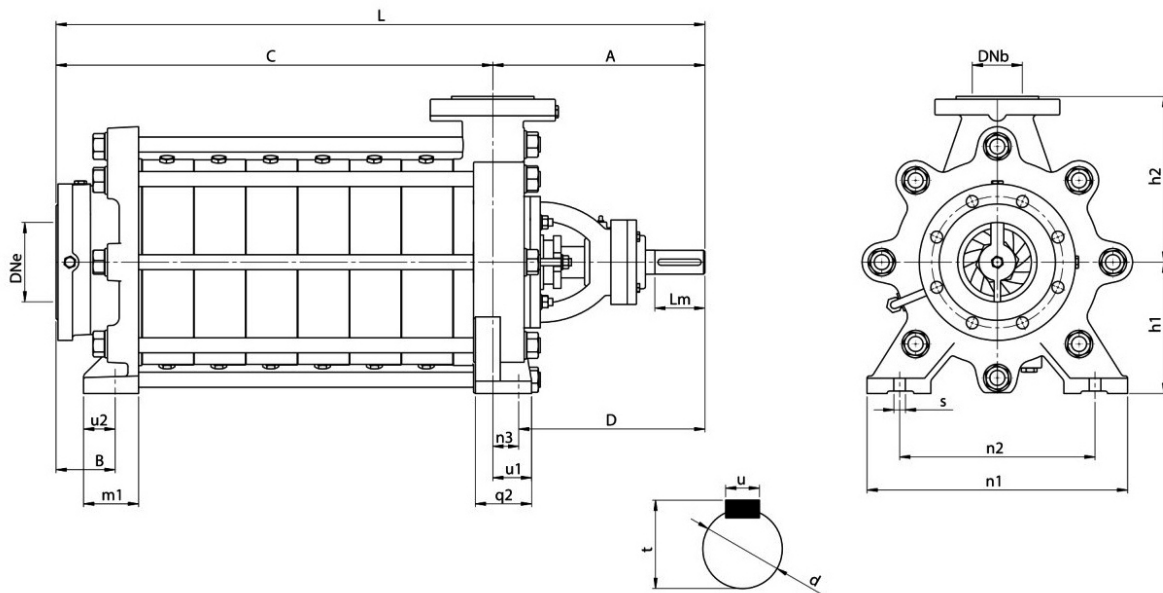
Dimensions:

Inlet and Outlet Flange	
DNe	DNb
5	3

Shaft Dimensions (inch)			
d	Lm	t	u
1.5	3.1	1.5	0.4

Pump Installation Size (inch)												
A	B	D	L	h1	h2	q2	u1	u2	m1	n1	n2	s
13.4	2.8	11.7	C+13.4	8.3	10.4	3.5	2.4	1.1	3.5	16.3	13.4	0.6

"C" Dimensions by Stage (inch)											
2	3	4	5	6	7	8	9	10	11	12	13
11.3	14.4	17.7	21	24.3	27.5	30.8	34.1	37.3	40.6	-	-

Project	Project ID	Created by	Created on	Last update
---------	------------	------------	------------	-------------



Performance Curves

Multi Stage Pump - GARS-U 80/02

Revision no.

Page:

2

Receiver

From

 Company name
 Respons. Department
 Person in charge
 Phone number
 Fax no
 E-mail address

Pump (GGG40)		Motor	(PN 40)		EFF(0.70%)	Q 220	Power			
Type	Quantity Impeller	hp	DNe	DNb	Safe Motor Power (hp)	rpm	Head (ft)		Gal/m	
GARS-U 80/02	2	92.5	5	3	135	3600	Max.	656.2	Min.	176.1
		114.2	5	3		3600	Rate	524.9	Rate	616.4
		125.1	5	3		3600	Min.	410.1	Max.	792.5

ARS-U 80-02 (3600RPM)

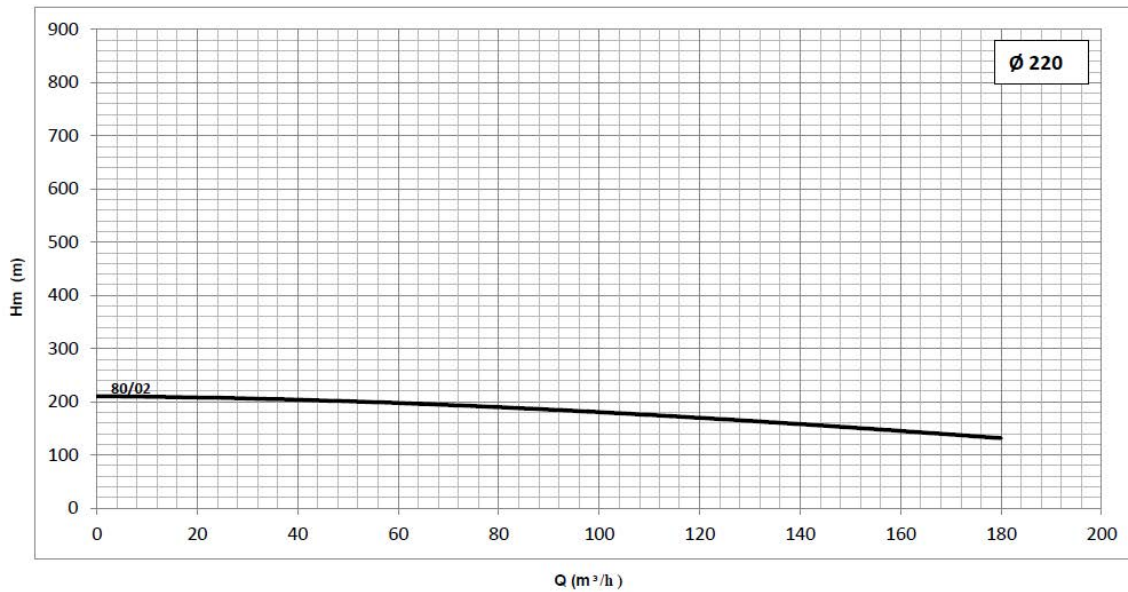

Parts List:

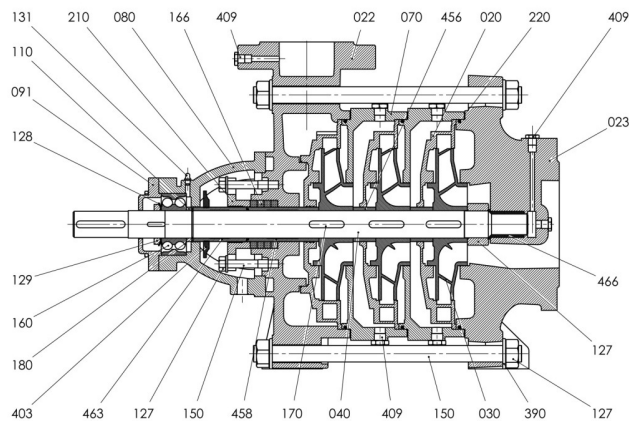

Diffuser	020	Bearing	160
Suction Body	023	Soft Packing	166
Discharge Body	022	Pin	170
Impeller	030	Ring	180
Shaft	040	Connection Support	210
Stage Body	070	O-Ring	220
Bearing Housing	080	Washer	390
Bearing Cover (Coupling)	091	Throw Protection	403
Bearing Setting Sleeve	110	Bolt	409
Nut	127	Impeller Stage Sleeve	456
Protection Sheet	128	Seal Sleeve (Discharge)	458
Nut	129	Setting Sleeve (Suction & Discharge)	463
Grease Nipple	131	Suction Housing	466
Casing Tiebolt	150		

Project

Project ID

Created by

Created on

Last update