



Technical Data

Vertical Multistage - SBI 1-15

Revision no.

Page:
1

Receiver

From

Company name
Respons. Department
Person in charge
Phone number
Fax no
E-mail address



Brand: Gol Pumps
Model: SBI 1-15



Dimensions:

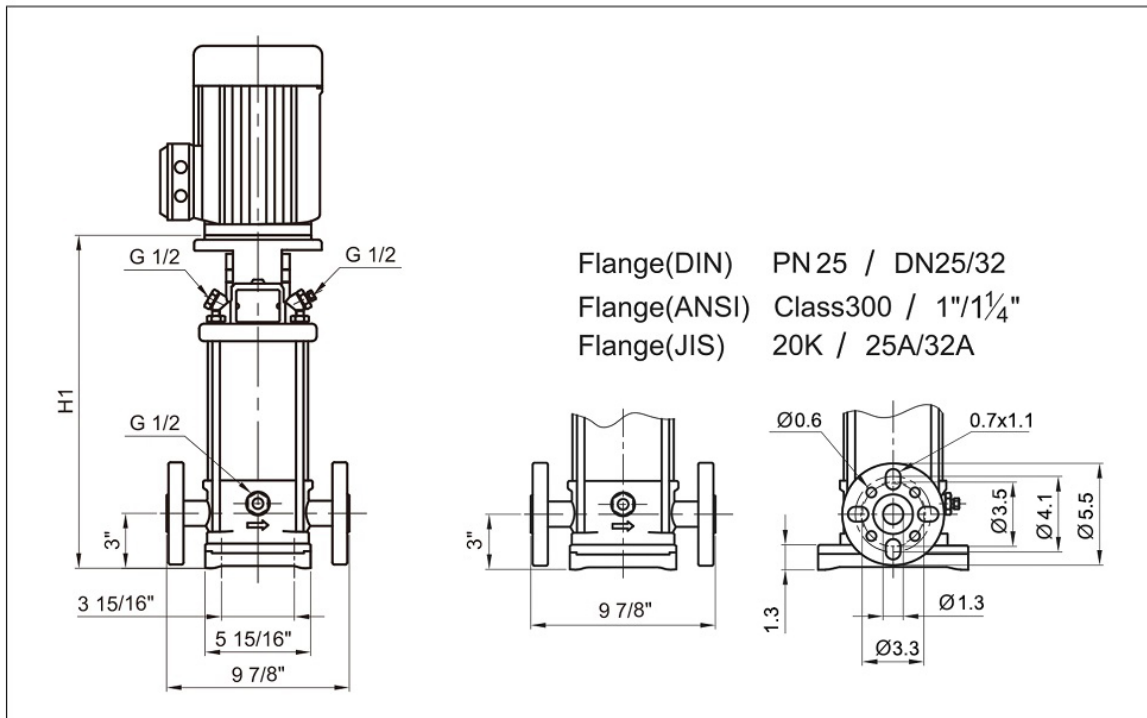

Pump Installation Size (inch)						
DIN Flange		Port Size		D1	D2	Net Weight
H1	H2	DNA	DNM			Lb.
20.5	32.1	1 1/4	1 1/4	7	5.6	83.8

Project	Project ID	Created by	Created on	Last update
---------	------------	------------	------------	-------------



Performance Curves

Vertical Multistage - SBI 1-15

Revision no.

Page:
2

Receiver

From

Company name
Respons. Department
Person in charge
Phone number
Fax no
E-mail address

Model	Port Size (in.)		Flow	HP	Volts	Amps	Phase	Max. Head	Max. Suction	Max. PSI
	DNA	DNM	GPH		V	I Max.	Ph	Ft.	Ft.	
SBI 1-15	1 1/4	1 1/4	780	2	230	9.6	Single	442	17	196

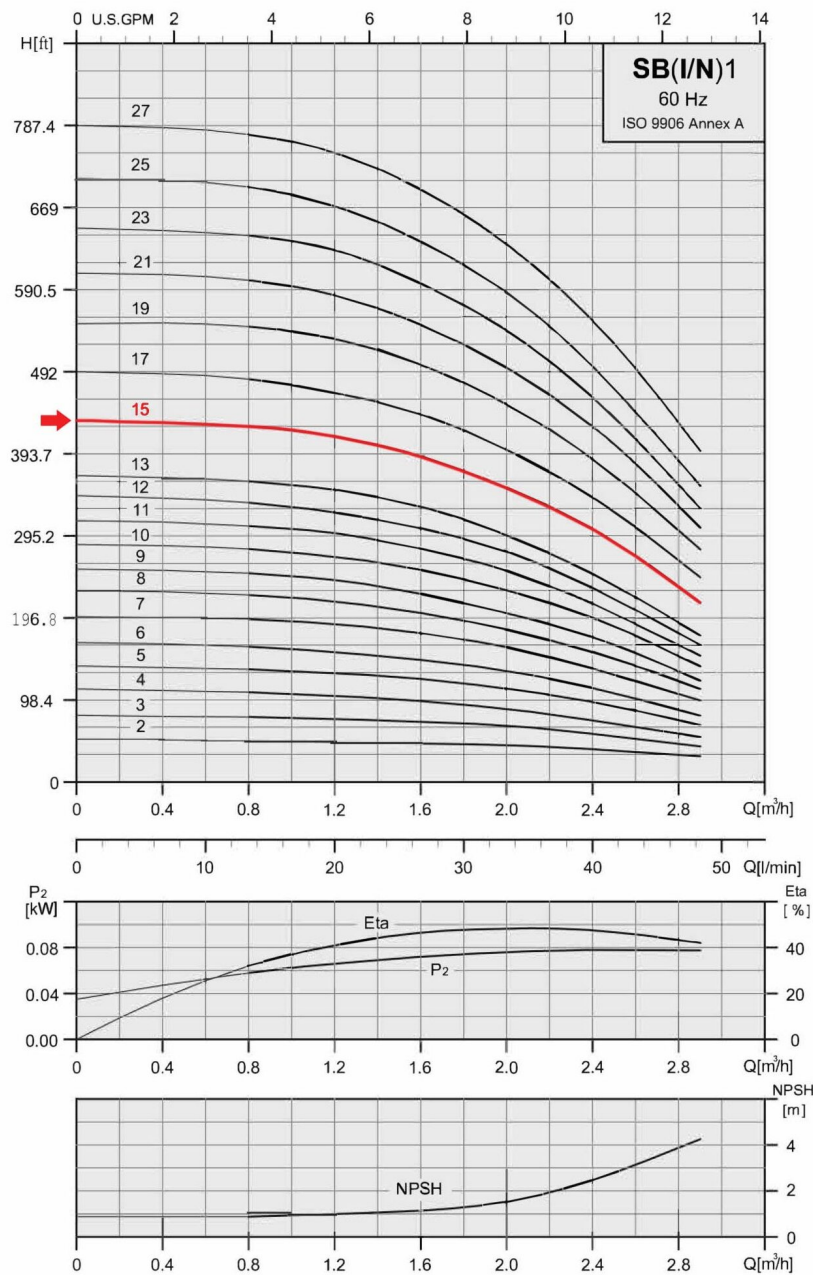

Project	Project ID	Created by	Created on	Last update
---------	------------	------------	------------	-------------



Parts and Materials

Vertical Multistage - SBI 1-15

Revision no.

Page:

3

Receiver

From

 Company name
 Respons. Department
 Person in charge
 Phone number
 Fax no
 E-mail address

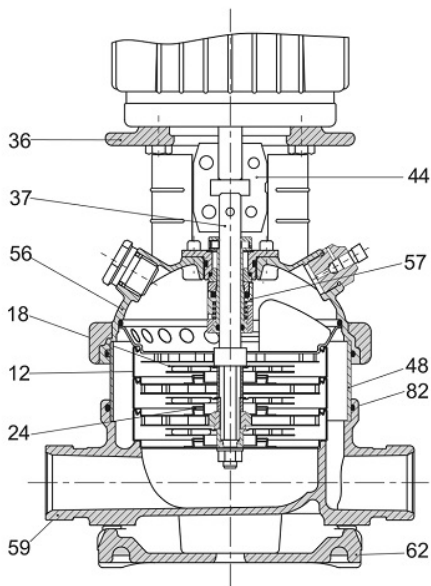

Parts List	Material	Standard
36 Pump Head	Cast Iron	ASTM 65-45-12
56 Pump Head Cover	Stainless Steel	AISI 304
18 Impeller	Stainless Steel	AISI 304
37 Shaft	Stainless Steel	AISI 304
48 Outer Sleeve	Stainless Steel	AISI 304
82 O-ring for Outer Sleeve	EPDM	
12 Chamber	Stainless Steel	AISI 304
24 Neck Ring	PTFE	
59 Base	Cast Iron	
62 Base Plate	Cast Iron	ASTM 25B
44 Coupling	Fe-Cu-C	MPIF FC0525
57 Mechanical Seal	Cartridge Type	

Project

Project ID

Created by

Created on

Last update