



Technical Data

Vertical Multistage - SBN 90-3

Revision no.

Page:
 1

Receiver

From

Company name
 Respons. Department
 Person in charge
 Phone number
 Fax no
 E-mail address



Brand: Gol Pumps
Model: SBN 90-3



Dimensions:

* The Flange (ANSI) 300lb is not included. If you wish, you have to select the option when adding the product to the cart.

* Flange (ANSI) 4" 300 lb.R.F. Stages 4-2~4-1

Flange (DIN)
PN16 / DN100

Pump Installation Size (inch)						
DIN Flange		Port Size		D1	D2	Net Weight
H1	H2	DNA	DNM			Lb.
34.3	61.4	4	4	17.6	12.8	921.6

Project	Project ID	Created by	Created on	Last update
---------	------------	------------	------------	-------------



Performance Curves

Vertical Multistage - SBN 90-3

Revision no.

Page:
2

Receiver

From

Company name
Respons. Department
Person in charge
Phone number
Fax no
E-mail address

Model	Port Size (in.)		Flow	HP	Volts	Amps	Phase	Max. Head	Max. Suction	Max. PSI
	DNA	DNM	GPH		V	I Max.	Ph	Ft.	Ft.	
SBN 90-3	4	4	38400	60	460	78.2	Three	498	17	220

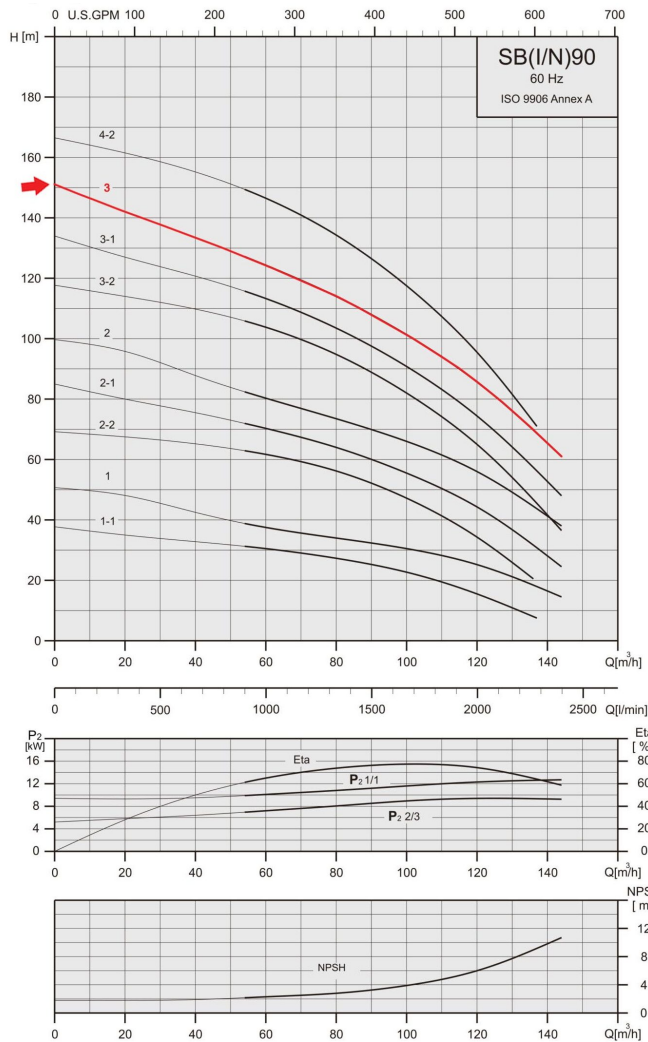

Project	Project ID	Created by	Created on	Last update
---------	------------	------------	------------	-------------



Parts and Materials

Vertical Multistage - SBN 90-3

Revision no.

Page:

3

Receiver

From

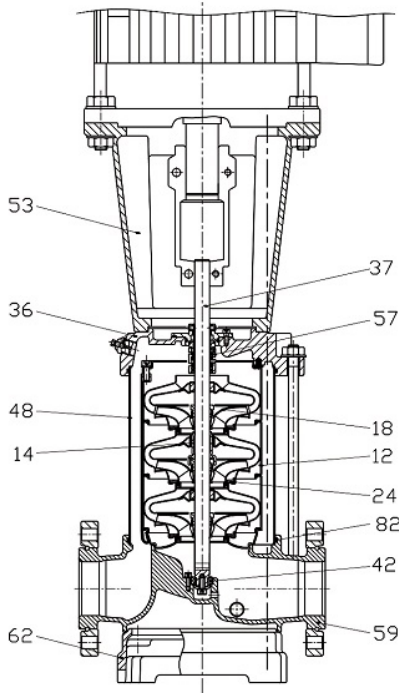
 Company name
 Respons. Department
 Person in charge
 Phone number
 Fax no
 E-mail address

Parts List

Material

Standard

36	Pump Head	Stainless Steel	AISI 316
53	Motor Bracket	Cast Iron	ASTM 35B
18	Impeller	Stainless Steel	AISI 316
37	Shaft	Stainless Steel	AISI 316
48	Outer Sleeve	Stainless Steel	AISI 316
82	O-ring for Outer Sleeve	EPDM	
12	Chamber	Stainless Steel	AISI 316
24	Neck Ring	Carbon Fiber + POB + PTFE	
59	Base	Stainless Steel	AISI 316
62	Base Plate	Cast Iron	ASTM 35B
57	Mechanical Seal	Cartridge Type	
14	Bearing Ring	POB + Graphite + PTFE	
42	Bottom Bearing Ring	Tungsten Carbide	

Project

Project ID

Created by

Created on

Last update