

APPLICAZIONI

Elettropompe autoadescenti Jet Inox garantiscono un'ottima resa idraulica e una notevole capacità di pressione. Possono aspirare fino a 8 mt. di profondità e sono in grado di funzionare perfettamente anche in presenza di acque miscelate a gas. Adatte per l'alimentazione di acqua potabile, il sollevamento e la distribuzione negli impianti domestici a mezzo di piccoli e medi serbatoi (autoclavi).

APPLICATION

Selfpriming jet water pumps with a very high hydraulic performance and a considerable pressure capacity. Able to pump up to mt. 8 depth and work perfectly even in gas mixed water. Suitable for drinkable water, water lifting and distribution in domestic fittings by small and medium sized tanks.



CAM 80



CAM 85-88



GIRANTE - IMPELLER
80-85



GIRANTE - IMPELLER
88

LIMITI D'IMPIEGO

- Temperatura liquido fino a 35°C (per un uso domestico secondo EN 60335-2-41)
- Temperatura max. liquido: 35°C (per altri impieghi)
- Temperatura ambiente fino a 40°C
- Altezza d'aspirazione manometrica fino a 8 mt.
- Servizio continuo

MOTORE

- Monofase 230V-60Hz
- Trifase 230/400V-60Hz
- Motore elettrico ad induzione a 2 poli (n = 2850 min⁻¹)
- Isolamento Classe F
- Protezione IP 44

MATERIALI

- | | |
|-----------------------|-----------------------|
| - Corpo pompa | Acciaio Inox AISI 304 |
| - Supporto motore | Alluminio |
| - Girante (80-85) | Noryl |
| - Girante (88) | Acciaio Inox AISI 304 |
| - Diffusore | Noryl |
| - Flangia portatenuta | Acciaio Inox AISI 304 |
| - Albero motore | Acciaio Inox AISI 304 |
| - Tenute meccaniche | Ceramica/Grafite/NBR |

OPERATING CONDITIONS

- Liquid temperature up to 35°C (for home use according to EN 60335-2-41)
- Max. liquid temperature: 35°C (for other uses)
- Ambient temperature up to 40°C
- Total suction lift up to 8 mt.
- Continuous duty

MOTOR

- Single-phase 230V-60Hz
- Three-phase 230/400V-60Hz
- Two-Pole induction motor (n = 2850 min⁻¹)
- Insulation Class F
- Protection IP 44

MATERIALS

- | | |
|------------------------|--------------------------|
| - Pump body | Stainless Steel AISI 304 |
| - Motor Support | Aluminium |
| - Impeller (CAM 80-85) | Noryl |
| - Impeller (88) | Stainless Steel AISI 304 |
| - Diffuser | Noryl |
| - Pump flange | Stainless Steel AISI 304 |
| - Shaft with rotor | Stainless Steel AISI 304 |
| - Mechanical seal | Ceramic/Graphite/NBR |

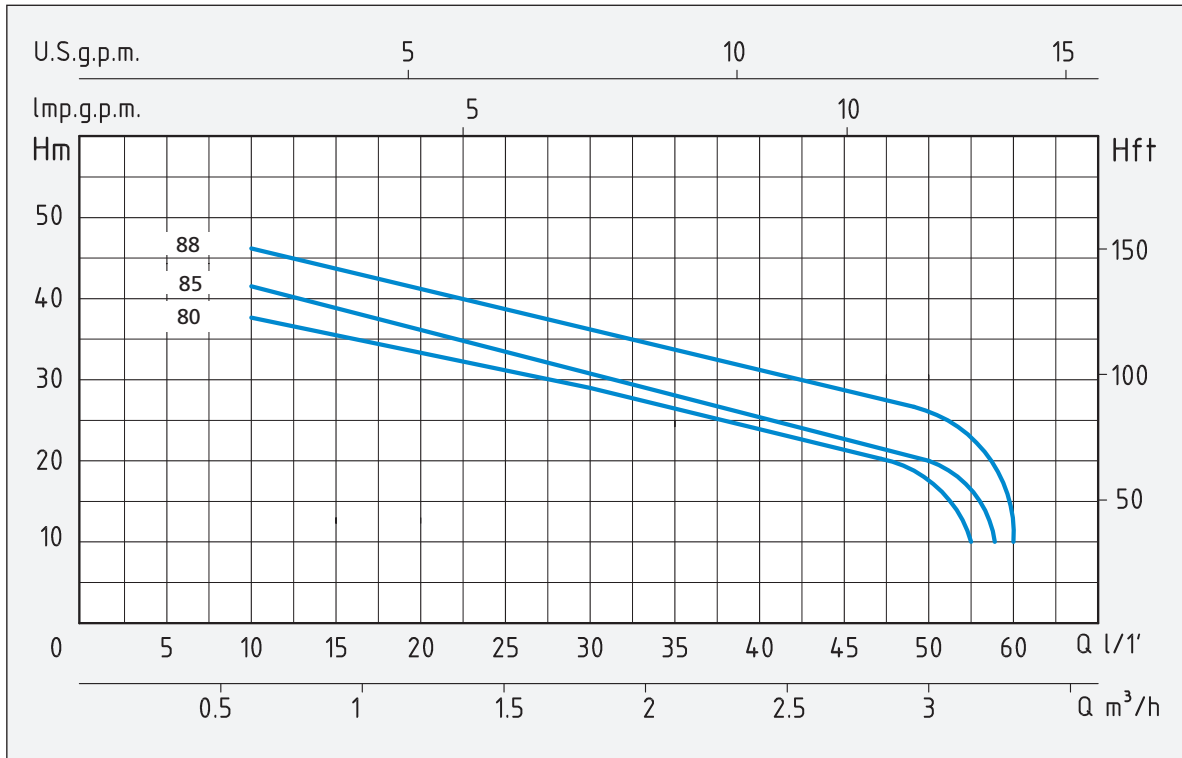

TIPO TYPE		POTENZA NOMINALE NOMINAL POWER		POTENZA ASSORBITA INPUT POWER	AMPERE		Q = PORTATA - CAPACITY									
Monofase Single-phase	Trifase Three-phase	P2		P1	Monofase Single-phase	Trifase Three-phase	m³/h	0,6	0,9	1,2	1,5	1,8	2,1	2,4	2,7	3
		HP	kW	kW			lt/1'	10	15	20	25	30	35	40	45	50
Prevalenza manometrica totale in m.C.A. - Total head in meters w.c.																
CAM 80		0,75	0,55	0,8	3,8		H (m)	38	36	34	32	29	27	25	22	19
CAM 85		0,9	0,7	0,9	4			42	40	36	33	31	28	26	24	20
CAM 88	CA 88	1	0,75	1,1	5	2,5		46	43	40	38	35	32	30	29	26

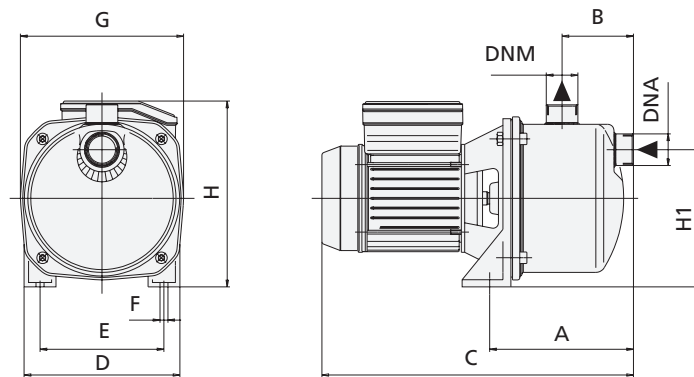

TIPO TYPE		DIMENSIONI mm - DIMENSIONS mm											DIMENSIONI DIMENSIONS mm			PESO WEIGHT
Monofase Single-phase	Trifase Three-phase	A	B	C	D	E	F	G	H	H1	DNA	DNM	P	L	H	Kg
		CAM 80		163	72	320	162	126	9	166	180	123	1"	1"	176	350
CAM 85		163	81	343	176	140	9	184	200	149	1"	1"	200	414	228	7,7
CAM 88	CA 88	163	81	370	176	140	9	184	200	149	1"	1"	200	414	228	10,2