

Receiver

From

 Company name
 Respons. Department
 Person in charge
 Phone number
 Fax no
 E-mail address

UNI EN ISO 9906-A

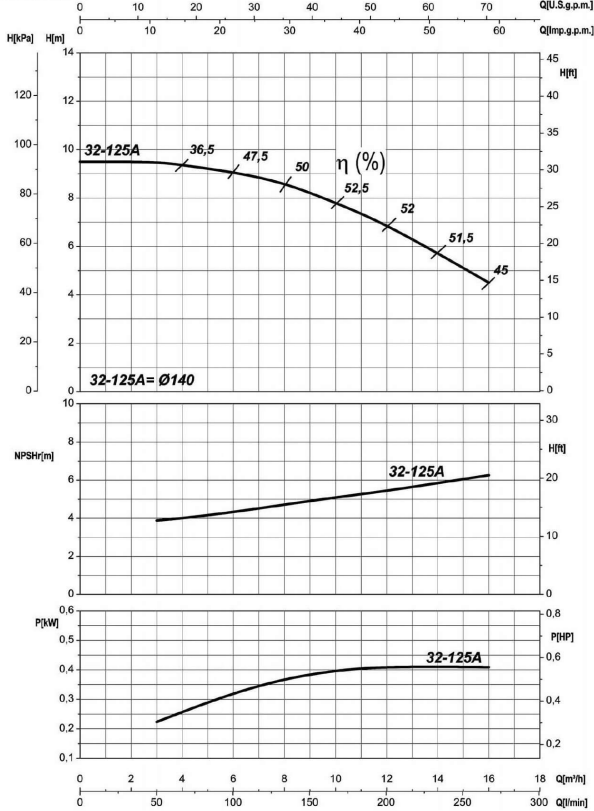

Operating data specification

Nominal flow	US g.p.m. 0
Nominal head	ft 0
Static head	ft 0
NPSH - v value of plant	ft 0
Inlet pressure	psi 1.42
Fluid	Water, pure
Operating temperature t A	°F 68
Density at t A	lb/ft³ 62.32
Kin. viscosity at t A	ft²/s 1.082E-5

Pump

Pump name		6IR4P 32-125A	
Size		50/32/125	
Design			
Speed	rpm 1800	No of stages	1
Impeller type			
Flow	Nominal	US g.p.m.	
	Max-	US g.p.m. 70.5	
	Min-	US g.p.m. 13.2	
Head	Nominal	ft	
	Max-	ft 31.1	
	Min-	ft 14.9	
Head H(Q=0)		ft 31.3	
NPSH 3%		ft	
Max. working pressure		psi 13.6	
Shaft power		hp	
Efficiency		%	
Max absorbed power		hp 0.59259	

Materials Pump

Shaft	Stainless steel AISI 431 (1.4057)
Impeller	Cast iron EN-GJL-250
Pump body	Cast iron EN-GJL-250
Seal disc	Cast iron EN-GJL-250
Gasket	Natural fiber
Mechanical seal	BVEG (Grafito/Ossido Allumina/EPDM)

Dimensions in inch

a 3¹/₈
 b 1¹⁵/₁₆
 DNA 1¹⁵/₁₆
 DNM 1¹/₄
 f 13³/₈
 h1 4⁷/₁₆
 h2 5¹/₂
 m1 3¹⁵/₁₆
 m2 2³/₄
 n1 7¹/₂
 n2 5¹/₂
 s 9¹/₁₆
 w 9¹/₂

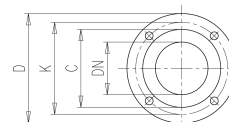
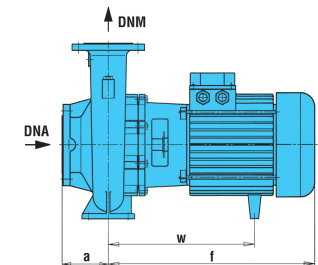
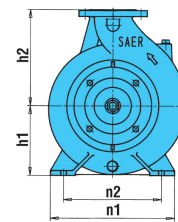

C 3³/₁₆ C 4
 D 5¹/₂ D 6¹/₂
 DN 1¹/₄ DN 1¹⁵/₁₆
 K 3¹⁵/₁₆ K 4¹⁵/₁₆
 n° 3¹/₁₆ n° 3¹/₁₆
 øn 3³/₄ øn 3³/₄

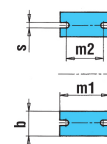

Motor		Frame size	80	
Manufacturer / Type		SAER MEC80-4P-0.37		
Rated power	hp	0.49618	Efficiency 4/4	74.5 %
Electric current	A	5.2/2.6 A	Speed	rpm 1800
Electric voltage	V	115/230V	1~	Hz 60
Starting mode		Unknown		
Degree of protection		IP 55	Insulation class	F

Remarks:

Project	Project ID	Created by	Created on	Last update
			2022-08-01	

Receiver

From

 Company name
 Respons. Department
 Person in charge
 Phone number
 Fax no
 E-mail address

Operating area	Flow	Head	Impeller type	
Operating data specification	0 US g.p.m.	0 ft	Impeller construction	Closed
Pump data	US g.p.m.		Sense of rotation	Clockwise from the drive end
	ft		Outlet width	DN 32
	Flow		Speed	rpm 1800
	Min.	Max.	Frequency	Hz 60 Hz
	US g.p.m.	US g.p.m.		
	13.2	70.4		
	Max. η	H(Q=0)	Shaft power P2	
	44.3	31.3	Max. η	
		25.6	P2(Q=0)	
			Max.	
			0.593	
			0.543	

 Performance data based to: Water, pure [100%]; 68°F; 62.3lb/ft³; 1.08E-5ft²/s

UNI EN ISO 9906:2012 - Grade 3B

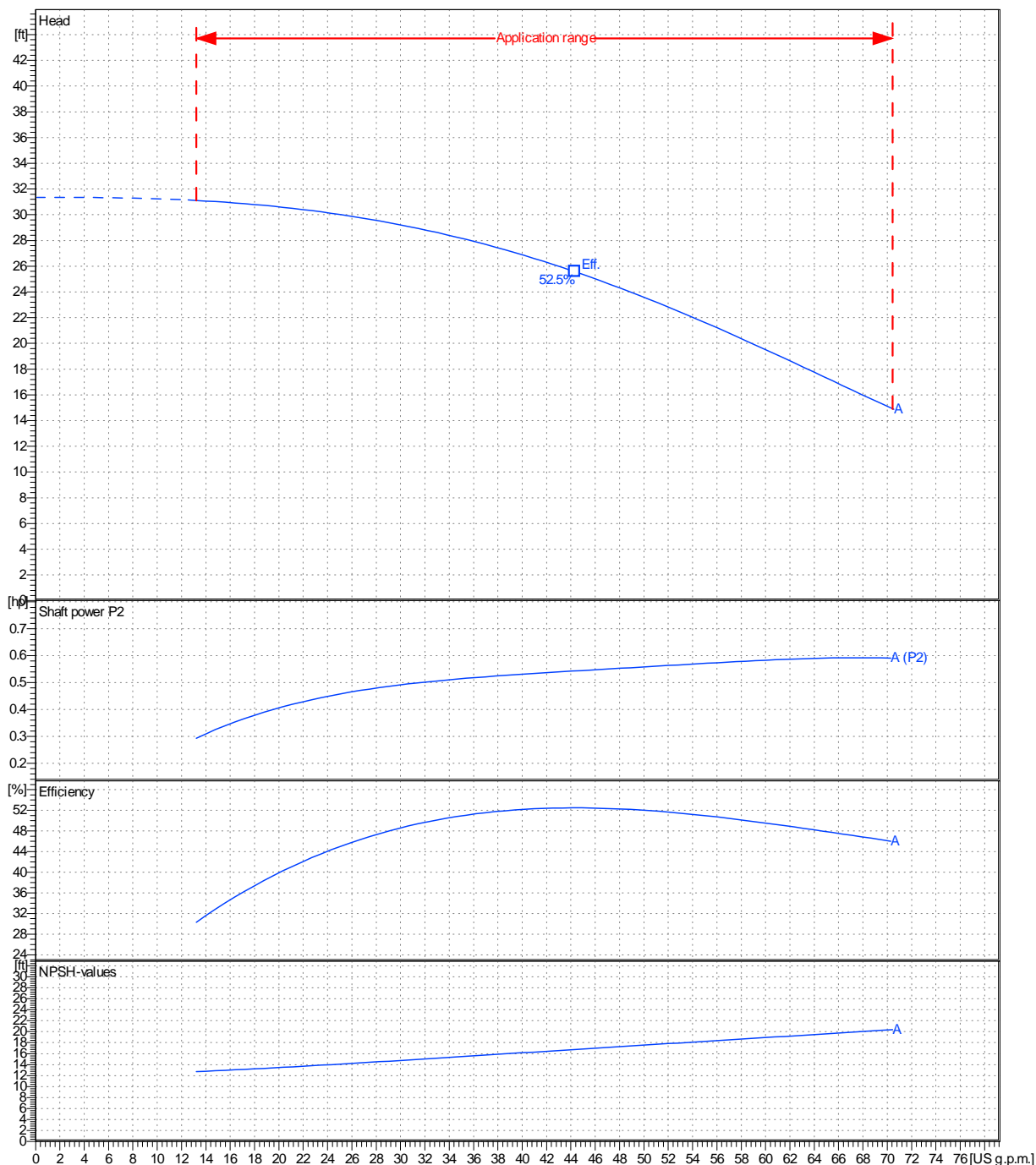

Project	Project ID	Created by	Created on	Last update
			2022-08-01	

Company name
Respons. Department
Person in charge
Phone number
Fax no
E-mail address

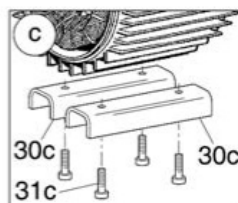
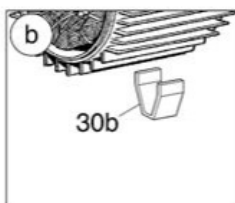
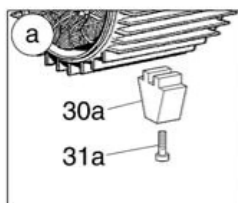
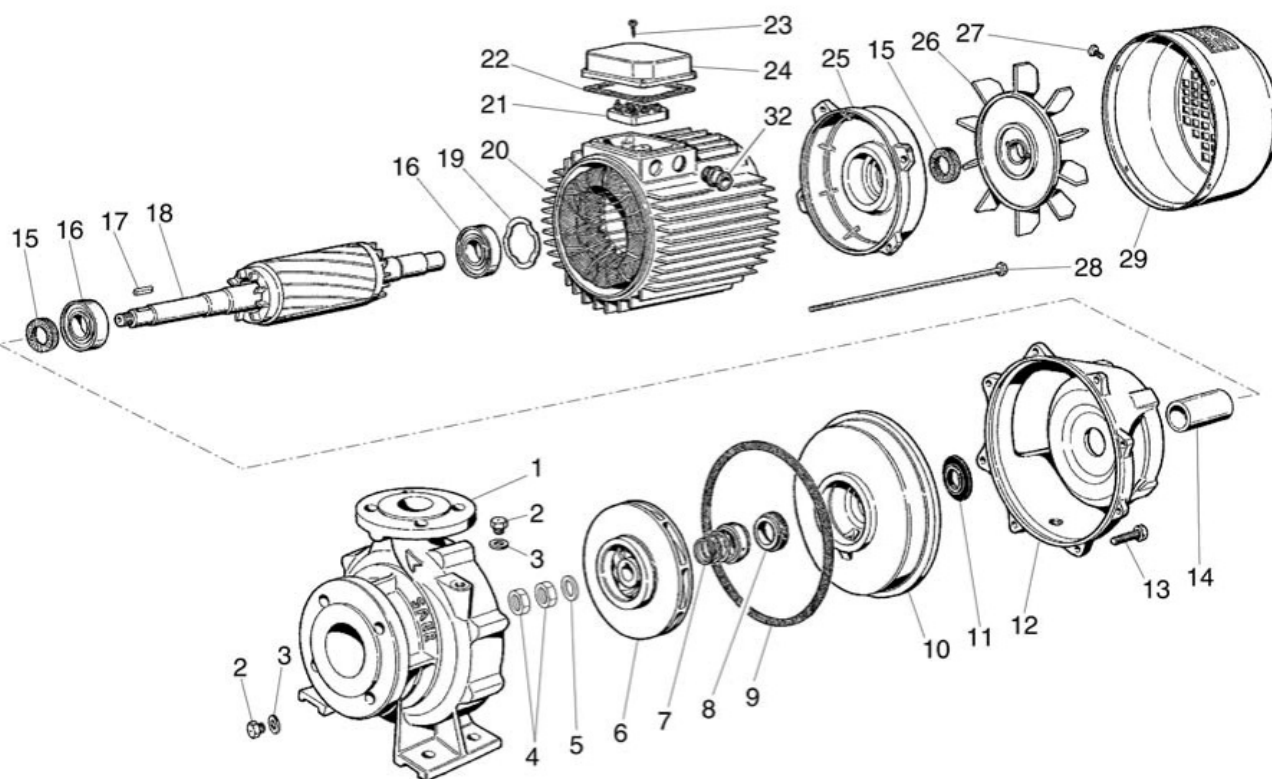

Project

Project ID

Created by

Created on
2022-08-01

Last update