



RECYCLED PAPER

CARING FOR THE FUTURE

CATALOG
USA 60Hz



CARING
FOR THE
FUTURE



It's not just a matter of talking about performance or technical features, or even stating that we are better than the competition.

We really need to start from people; from users. And if we give them something that can simplify or improve their lives, then they will be happy to follow us.





WATER BOOSTING



CONDITIONING



GARDENING & IRRIGATION



HEATING

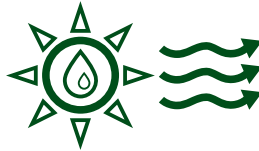

SOLAR HEATING



HOT WATER



DRAINAGE



EFFLUENT



SEWAGE

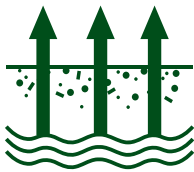

GROUND WATER



MACERATORS

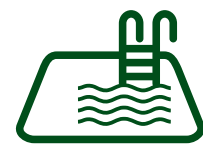

SWIMMING POOL



RAIN WATER REUSE



FIRE FIGHTING



IRRIGATION SYSTEMS

DCONNECT

PAGE 5

ESYBOX LINE

PAGE 13

CENTRIFUGAL & JET

PAGE 35

**SUBMERSIBLE PUMPS
AND MOTORS**

PAGE 63

SUMP & SEWAGE

PAGE 133

HVAC

PAGE 165

SWIMMING POOL

PAGE 207



THE PROFESSIONAL TRAINING BY



**DISTANT BUT CONNECTED.
MORE THAN EVER.**



Meet our experts with **training sessions** available at any time, **live webinars**, **technical discussions**, and **both live and on-demand content** covering all the latest DAB products.

DLARNING.DABPUMPS.COM

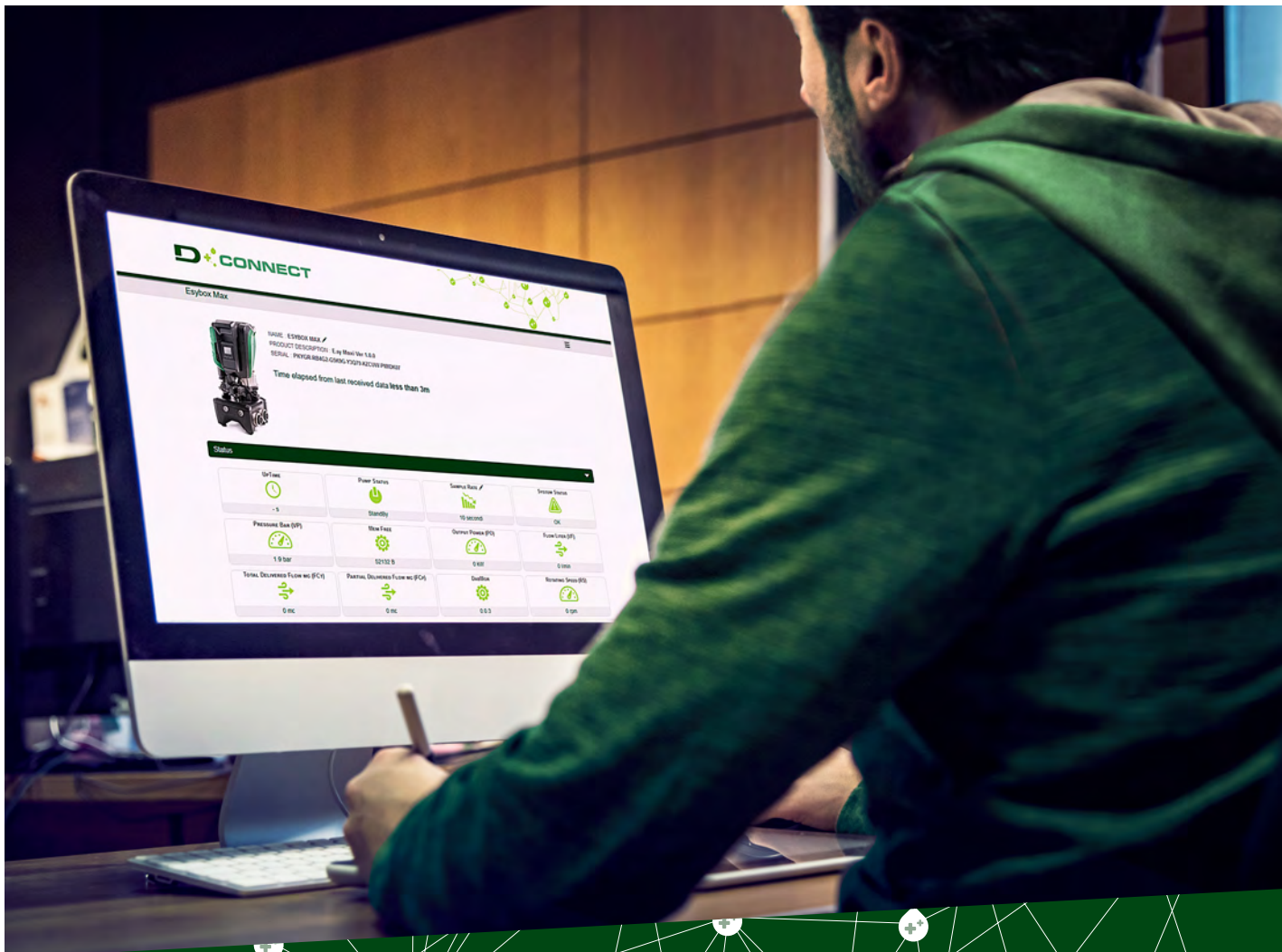

DCONNECT

CONTROL AND MANAGE YOUR INSTALLATIONS IN REAL TIME, WHEREVER YOU ARE

DConnect is the DAB cloud service, that allows you to remotely monitor and manage functional parameters of your pumps. Moreover, thanks to DConnect you can reset faults and alarms on site, if necessary. You only need an available Internet connection and a smartphone, a pc or a tablet.

It's also suitable for pre-existing installations.

YOUR SYSTEMS ARE JUST A CLICK AWAY

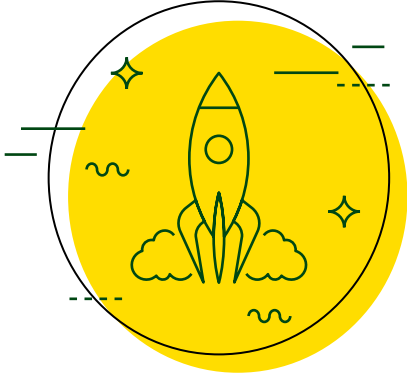

THE SERVICE THAT MAKES LIFE EASIER

DConnect makes monitoring DAB products easy and intuitive. All adjustments are also possible remotely. For total control with no surprises.

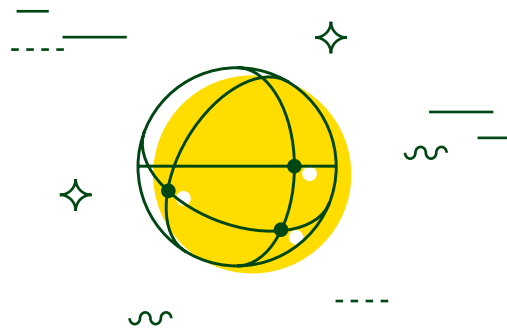

IMMEDIATELY READY TO USE

DConnect does not require specific infrastructures. The installation only requires an internet connection and a smartphone. Just follow the few steps of the connection wizard to connect your pumps.

TECHNOLOGY FOR EVERYONE

Based on state-of-the-art technology, the DConnect system offers many advantages over typical BMS systems.

WE ARE VERY CAREFUL ABOUT YOUR SAFETY

Dab takes data safety very seriously. This is why DConnect products are continuously updated and improved, to make sure that they always comply with the latest standards, in order to counteract any effects of the new dangers that are discovered every day.

UNRIVALLED ADVANTAGES

DConnect

TAILOR DESIGN

Developed for both residential and commercial building service application.

USE

No fixed work station is required as the DConnect is all about portability, the only thing you need is a internet connection.

SOFTWARE & HARDWARE

You do not need to buy any expensive software, nor do you need to pay for updates or for dedicated work stations.

VALUE

It lowers the overhead costs, increasing the value of your building.

D+CONNECT BOX



DConnect Box 2 expands the range of DConnect products. This latest addition is the ideal solution for small systems (connection of up to 4 products). It joins big brother DConnect Box, which can manage larger systems (connection of up to 8 products), and is compatible with a wide range of DAB products. Both can also be used on already installed products. All that is required is constant internet access at the place of installation.

APP & CLOUD

Using the DConnect App, available on App Store and Google Play, it is possible to check the settings of compatible products.

Taking advantage of the Cloud service, through the website internetofpumps.com or the **DConnect App**, it is also possible to remotely check the installation and receive alarms in real time, wherever you are, through an extremely clear and functional user interface.

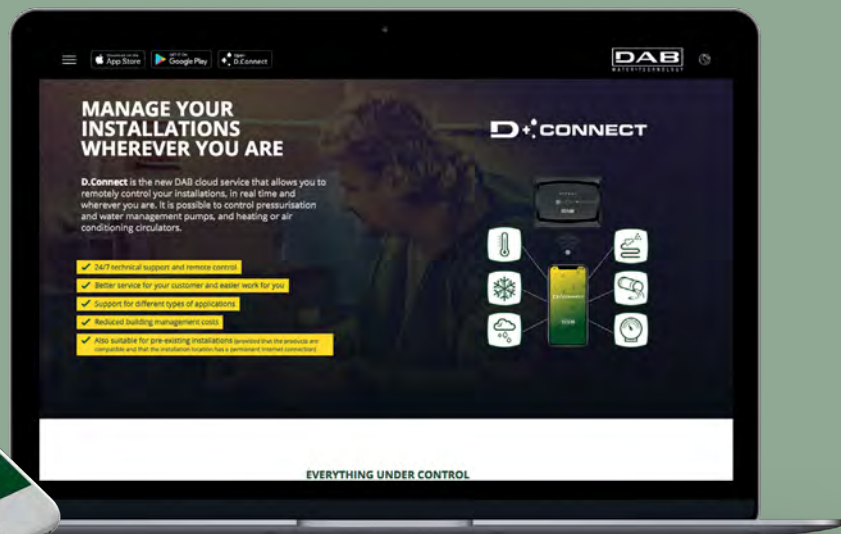

INTERNETOFPUMPS.COM

A SINGLE INTERFACE FOR EVERY APPLICATION

DConnect is suitable for pressurization systems, circulation systems and for installations for the recovery of waste water.

IT represents a high added value service that can be used with any system, irrespective of its nature and size and in the same environment and with the same instruments, from the individual houses to large structures.

Being modular, DConnect can manage up to 8 different electronic pumps in a highly simple and integrated manner.

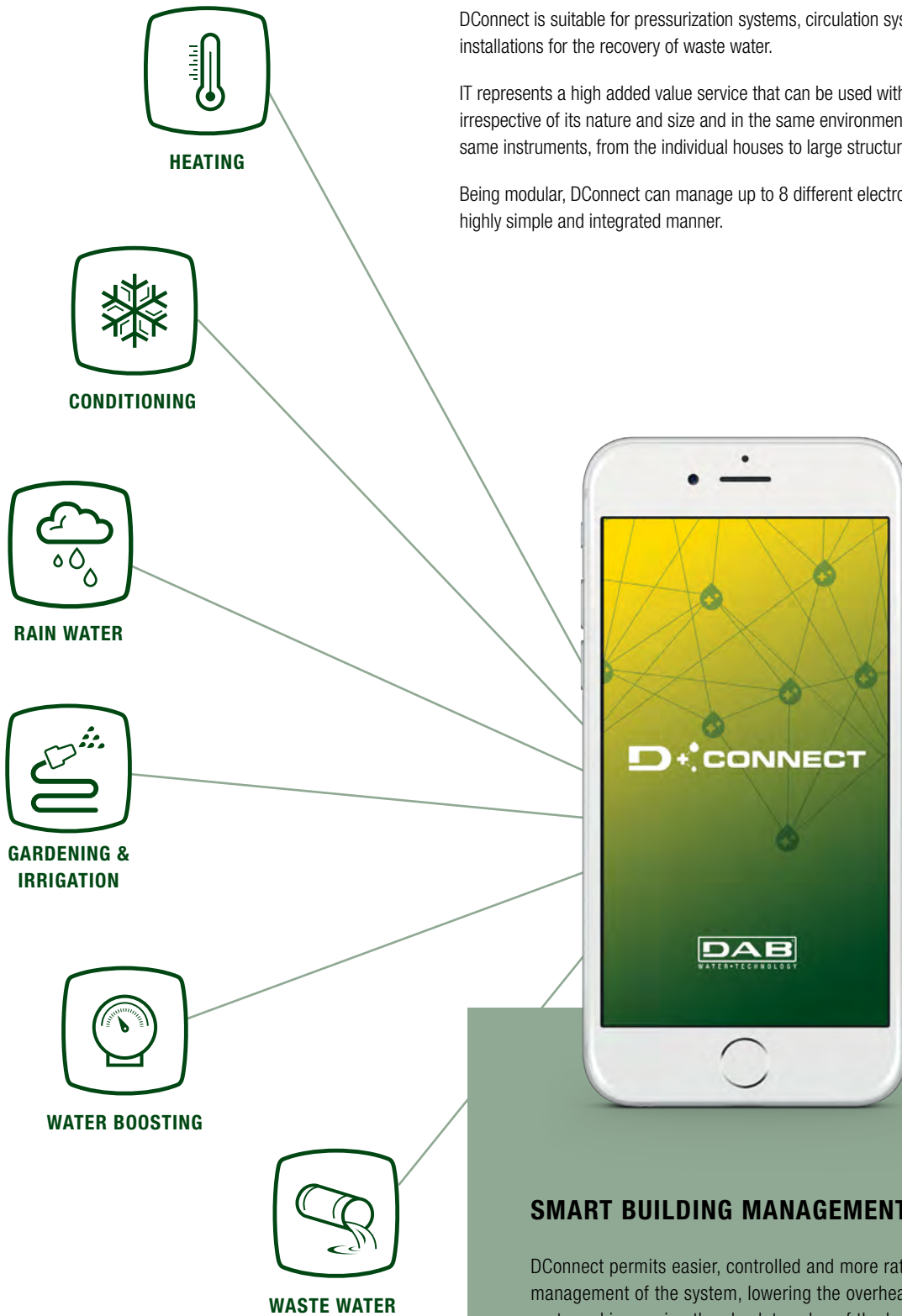

SMART BUILDING MANAGEMENT

DConnect permits easier, controlled and more rational management of the system, lowering the overhead costs and increasing the absolute value of the building in terms of efficiency and overall comfort.



**WITH EACH QUESTION,
AN ANSWER!
SCAN THE QR CODE AND
CONSULT OUR FAQ SECTION**

OPERATION DIAGRAM

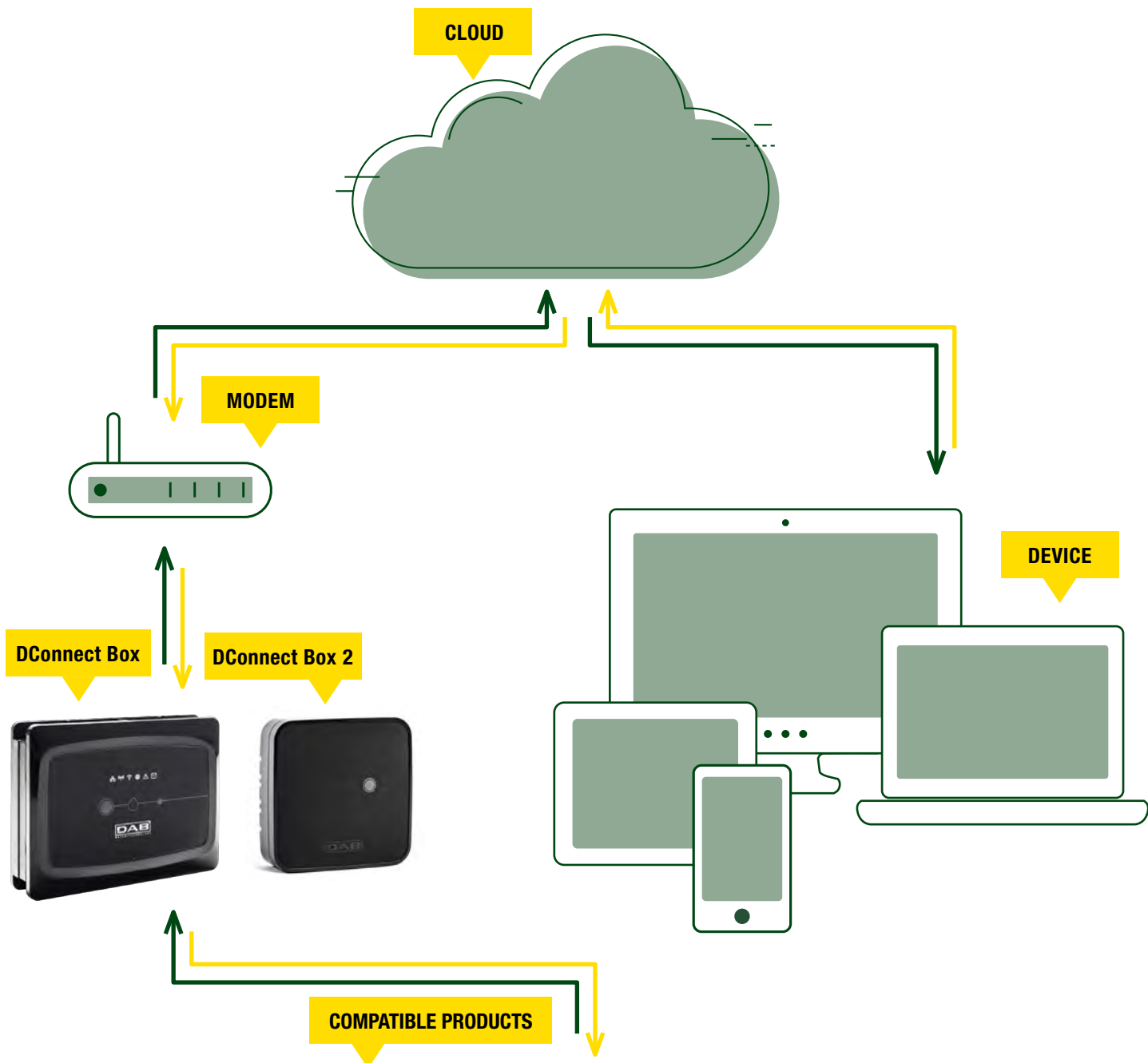

For more information visit: internetofpumps.com

COMPATIBLE PRODUCTS CONNECTIONS



DCONNECT BOX & ACCESSORIES

MODEL		CODE
	ETHERNET CABLE 7 ft (to use for LAN connection)	60188146
	DCONNECT BOX BMS ADAPTER KIT (MODBUS RTU RS485)	60198693
	DCONNECT BOX PANEL - IP 65 (DConnect Box included)	60198153
	DCONNECT BOX	60172819
	DCONNECT BOX 2	60198035 NEMA 5 PLUG to 120v NEMA 5/15P
		60198037 NEMA 6 PLUG to 230v NEMA 6/15P

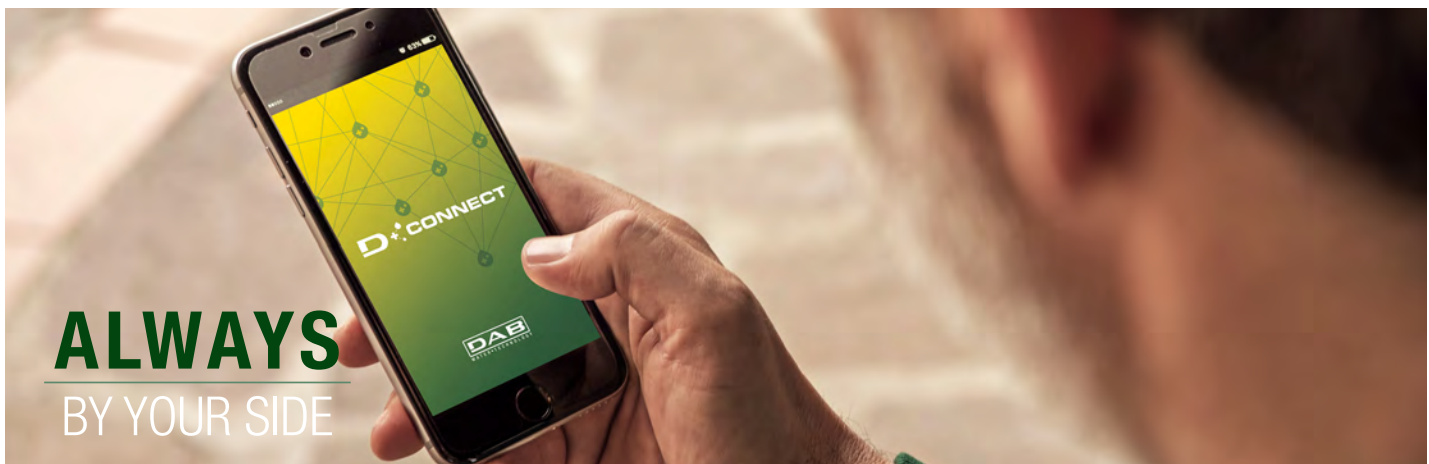



D+CONNECT

AFFORDABLE WEB BASED REMOTE CONTROL FOR EVERYONE

DConnect is the new DAB cloud service that allows you to remotely control your installations, in real time and wherever you are.



READY TO USE



ALWAYS CONNECTED



CLOSE TO THE CUSTOMER

INTERNETOFPUMPS.COM

DAB[®]
WATER • TECHNOLOGY



ESYBOX MINI³
ELECTRONIC PRESSURISATION SYSTEM

PAGE 14



ESYBOX MAX
ELECTRONIC BOOSTER SET

PAGE 22



ESYBOX
ELECTRONIC PRESSURIZATION SYSTEM

PAGE 16

ACCESSORIES

PAGE 18-21-31



ESYBOX DIVER
7" MULTISTAGE SUBMERSIBLE PUMPS WITH VARIABLE FREQUENCY DRIVE

PAGE 19

ESYBOX MINI³

ELECTRONIC PRESSURISATION SYSTEM



ESYBOX MINI³ is the DAB compact automatic pressurisation system for the water supply of a single dwelling. ESYBOX MINI³ guarantees the comfort of constant pressure (Pressure Set Point adjustable from 15 up to 80 psi) inside the system, and energy savings thanks to the inverter technology. Suitable for use with drinking water, in domestic systems, and in gardening applications. ESYBOX MINI³ does not require any additional components for its installation. It consists of a high frequency self-priming tripple impeller pump, management inverter electronics, pressure and flow sensors, adjustable high resolution LCD display with 0.2 gal built-in expansion tank, and cartridge check valve. The double suction and delivery ports allow both vertical and horizontal installation. Thanks to its compact sizes, installation is also possible in difficult places without high air exchange.

- Operating range** capacity up to 21.1 GPM; head up to 180 ft
- Liquid quality requirements** clean, free from solid or abrasive contaminants, non-viscous, non-aggressive, uncrystallised and chemically neutral.
- Liquid temperature range** from 32°F to +95°F for domestic use
- for other use** from 32°F to +104°F
- Maximum suction depth** 26 ft
- Maximum ambient temperature** +122°F
- Maximum operating pressure** 109 psi
- Motor protection rating** IPX4
- Insulation class** F
- Installation** horizontal or vertical fixed position
- Special versions on request** alternative types of electrical plug

esybox mini³



PAG. 5

ACCESSORIES
PAG. 18 - 31

TECHNICAL DATA

MODEL	CODE	N° IMPELLERS	ELECTRICAL DATA				HYDRAULIC DATA										DNA NPT	DNM NPT
			VOLTAGE 50 - 60 Hz	P1 MAX		In A	Q=GPM	2.6	5.3	7.9	10.6	13.2	15.8	18.5	21.1			
				kW	HP													
ESYBOX MINI ³ DV NPT USA PLUG	60188927	3	1x115-127V~ 1x208-240V~	0.85	1.1	4.8 9.6	H (ft)	180	180	161	128	102	75	46	13	1"	1"	

* By replacing the existing NEMA5-15P plug with a NEMA6-15P plug the pump can operate at 1x208-240 V

APPLICATIONS



Apartments up to 3 floors,
2 bathrooms and 538 ft² of garden.

SUITABLE FOR PUMPING WATER FROM:



WELLS DOWN TO 26 FT DEEP



RAINWATER COLLECTION TANKS



TANKS



MUNICIPAL WATER SUPPLY
WHERE PERMITTED BY LAW

SOUND
PRESSURE**
45
db(A)

17.3 x 10.6 x 9.4 in

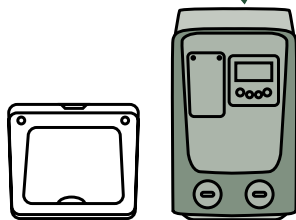

▶ HORIZONTAL ▶ VERTICAL

** Sound pressure measured at
3 ft distance in free field

esygrid

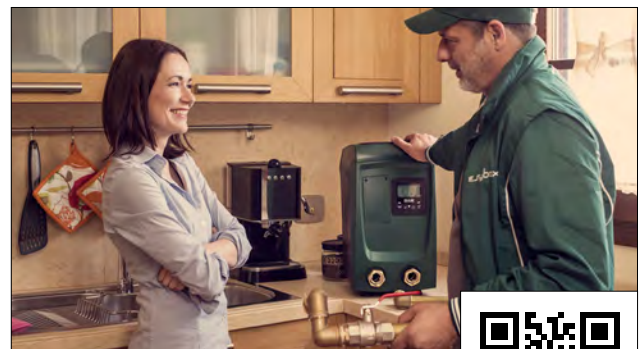

discover **esybox LINE**
<https://esyboxline.com>



ESYBOX MINI³

ELECTRONIC PRESSURISATION SYSTEM

RANGE PERFORMANCE

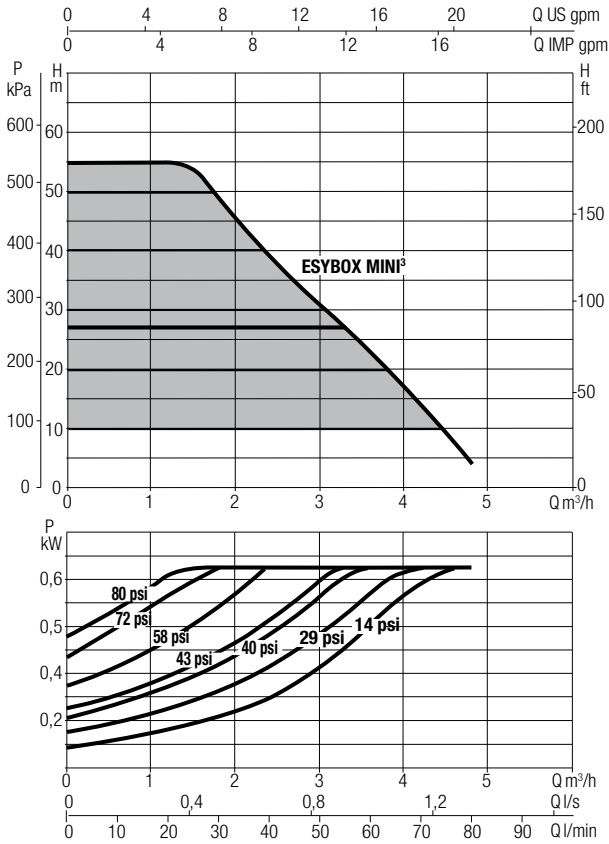

DIMENSIONS

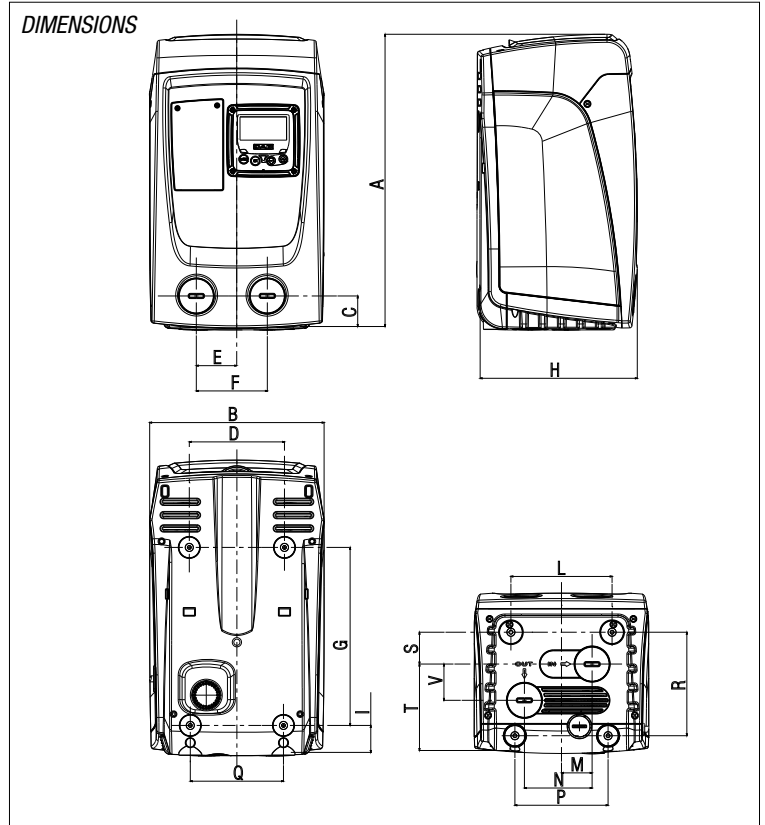

DIMENSIONS AND WEIGHTS

MODEL	A	B	C	D	E	F	G	H	I	L	M	N	P	Q	R	S	T	V	DNA	DNM	PACKING DIMENSIONS			WEIGHT lbs	Q.TY x PALLET
																					L/A	L/B	H		
ESYBOX MINI ³ DV NPT	17.3	10.4	1.8	5.6	2.4	4.2	10.5	9.3	1.6	6	1.8	4	5.5	5.5	6.1	1.9	5.1	2.1	1"	1"	11.8	19.7	12.6	32.2	18

ESYBOX

ELECTRONIC PRESSURIZATION SYSTEM



ESYBOX is DAB's integrated system for pressurization in domestic and residential applications.

ESYBOX does not require any additional components for installation. It consists of a self-priming multistage pump, electronic inverter management, flow and pressure sensors, high-resolution swivel LCD display and an integrated 0.5 gal expansion tank. It can be installed both vertically and horizontally and even in tight spaces without a high air exchange.

The water-cooled motor, the hull protection in ABS with sound-absorbing function, the vibration damping feet and electronics make it an absolutely quiet (**43 dB**) and compact.

The wireless capabilities facilitates the creation of pressurization units and connectivity with other DAB devices.

Degree of protection IP X 4

Insulation class F

Pumped liquid clean, free from solids or abrasive, non-aggressive, non-viscous, crystallized and not chemically neutral.

Maximum liquid temperature 104°F

Maximum ambient temperature 122°F

Maximum suction depth

self priming up to 26 ft

Maximum working pressure 116 psi

esybox



PAG. 5

ACCESSORIES
PAG. 18 - 31

TECHNICAL DATA

MODEL	CODE	ELECTRICAL DATA			HYDRAULIC DATA														
		VOLTAGE 50 - 60 Hz	P1 MAX		I MAX A	Q=GPM	0	2.6	5.3	7.9	10.6	13.2	15.8	18.5	21.1	23.8	26.4	29	31.7
			kw	HP															
ESYBOX - NPT US PLUG	60161182	1x220-240V ~	1.55	2.1	10	H (ft)	213	208	202	195	187	174	157	136	115	90	62	33	7

APPLICATIONS



Esybox

Houses and small apartment complexes up to 6 floors and a maximum of 9 apartments.



Esytwin

Small and large apartment complexes up to 9 floors and a maximum of 17 apartments.

SUITABLE FOR PUMPING WATER FROM:



WELLS DOWN TO 26 FT DEEP



RAINWATER COLLECTION TANKS



TANKS



MUNICIPAL WATER SUPPLY
WHERE PERMITTED BY LAW



ESYGRID

INSECT GRILLS

discover **esybox LINE**
<https://esyboxline.com>



ESYBOX

ELECTRONIC PRESSURIZATION SYSTEM

RANGE PERFORMANCE

ESYBOX

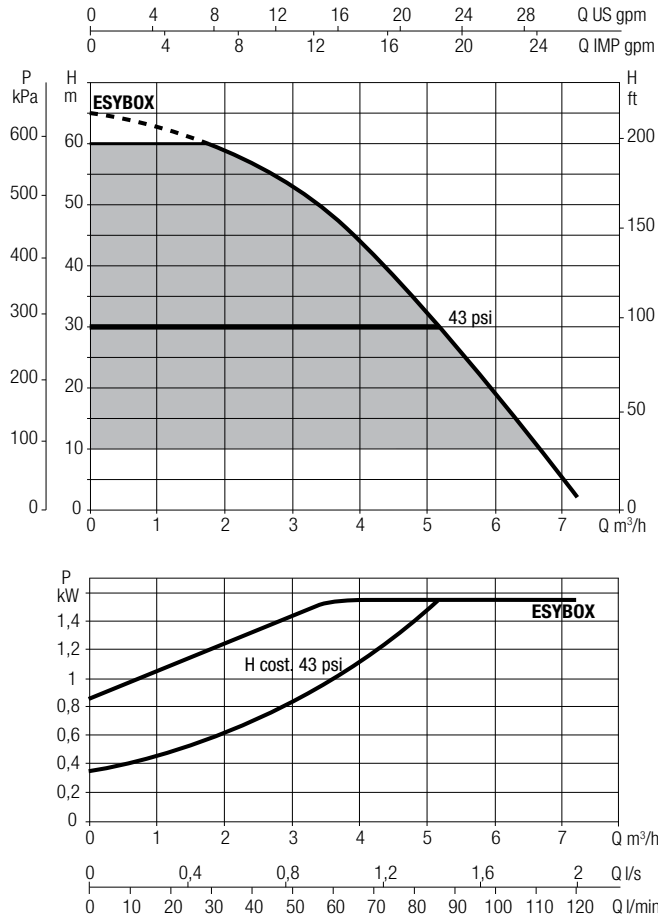

ESYBOX TWIN

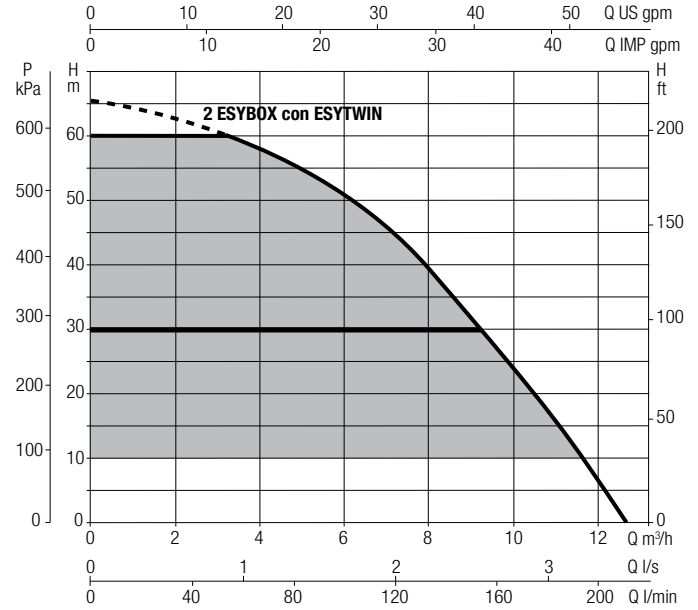



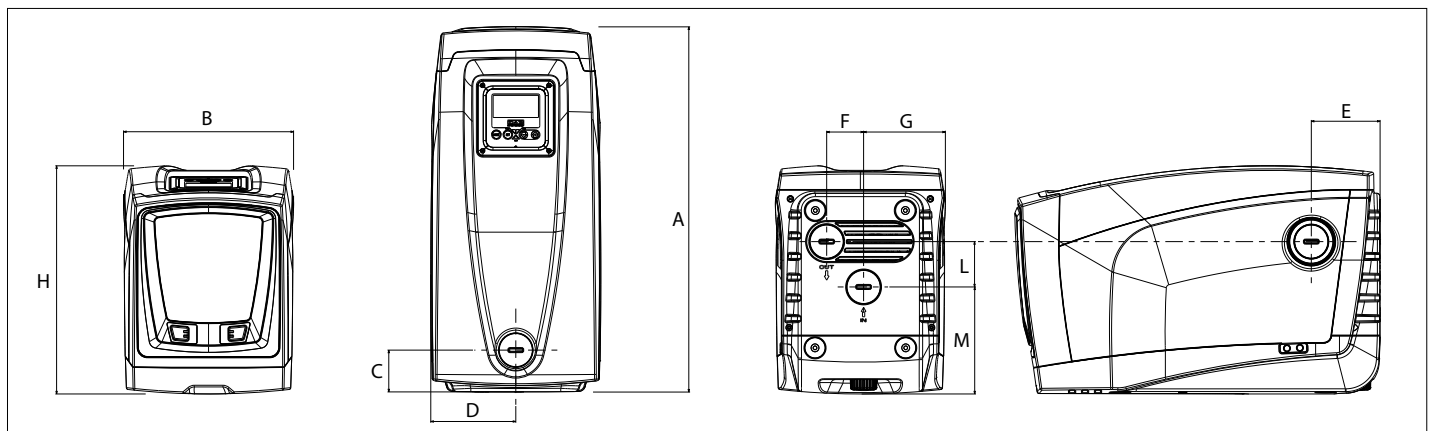







DIMENSIONS AND WEIGHTS



MODEL	A	B	C	D	E	F	G	H	L	M	DNA F NPT	DNM F NPT	PACKING DIMENSIONS			WEIGHT lbs	Q.TY x PALLET
													L/A	L/B	H		
ESYBOX - NPT	22.2	10.4	2.6	5.2	4.2	2.2	5	14.3	2.8	6.5	1"	1"	27	14.2	19.3	59.5	6

ESYBOX - ACCESSORIES

ELECTRONIC PRESSURIZATION SYSTEM

	DESCRIPTION	CODE
    	<p>DCONNECT BOX 2</p> <p>Thanks to DConnect Box 2 and the new App you can check the pump, set the starting and stopping parameters, view the details of alarms and monitor the status of the system directly on your smartphone. (Only for DTron 3 and ESYBOX LINE products, included with Esybox Diver).</p>	<p>60198035 NEMA 5 PLUG to 120v NEMA 5/15P</p> <p>60198037 NEMA 6 PLUG to 230v NEMA 6/15P</p>
  <p>C US Drinking Water NSF/ANSI 61</p> <p>7.1 x 11.4 x 12.6 in</p>	<p>ESYDOCK</p> <p>Thanks to the 4 plumbing configuration possibilities the installation is fast, easy and flexible. It is complete with all the fittings required for connecting to the system. It incorporates anti vibration feet to ensure the same quietness as Esybox.</p>	60150514
  <p>C US Drinking Water NSF/ANSI 61</p> <p>9.1 x 29.5 x 13.8 in</p>	<p>ESYTWIN</p> <p>Esytwin is the evolution of Esydock, of which maintains all the benefits, for the creation of two groups of pumps. Esytwin offers exceptional performance thanks to possibility of combined operation with a reduced size of 50% compared to any other equivalent traditional system.</p>	60162081
	<p>KIT ESYLINK</p> <p>Esylink with power supply and enclosure</p>	60164735



**DELIVERY AND SUCTION
FITTING 1" ¼**



26.8 x 11.4 x 13.8 in



**KIT DIMENSIONS
28.7 x 29.5 x 13.8 in**

ESYBOX DIVER

7" MULTISTAGE SUBMERSIBLE PUMPS WITH VARIABLE FREQUENCY DRIVE



7" multi-stage electronic pump with variable frequency drive for clean water designed for use in wells, tanks or cisterns. The pump can be used submerged, partially submerged or on the surface (with the DOC68 accessory, supplied separately). The pump is suitable for pressurization, rainwater re-use and gardening and irrigation activities in residential building service.

The pump integrates the variable frequency drive for operation according to the system requirements a non-return valve and a stainless steel handle for transport. The electronic operation also protects against dry running and the VFD saves energy.

The suction height is adjustable from the bottom up to 3.1" . It is possible to connect a float and a level sensor without opening the pump maintaining a watertight seal thanks to the NFC (Near Field Communication) pocket. Equipped with expansion tank making the use of an additional expansion tank superfluous.

Wi-Fi connectivity as standard.

The DConnect Box 2 is included, by downloading the DConnect app for Android or iOS you can control the pump from your smartphone.

The pump is available in X version with 1" inlet and X kit which includes 3 ft suction hose and float to prevent the suction of impurities from the bottom. The whole pump is IP 68 certified, it can be used on the surface (with flooded suction).

If combined with an identical pump, two pumps can operate in alternate or simultaneous mode.

Flow rate maximum 31.7 GPM

Head up to 180 ft

Maximum immersion depth
39 ft standard version

Type of pumped liquid clean, free from solid or abrasive substances, non-viscous, non-aggressive, non-crystallized and chemically neutral.

Free passage 0.1 in

Liquid temperature range from
+32°F to +122°F

Set cut-in 35 psi (+-3)

Outlet connection thread 1" 1/4

Pump maximum diameter 7.3 in

Protection class IP 68

Motor insulation class F

Power cable and plug 49 ft

Possible type of installation fixed, horizontal or vertical. Submerged or semi-submerged. It can be installed on the surface, under the water level, or outside in a vertical position with the DOC68 accessory (supplied separately).

esybox DIVER



PAG. 5

ACCESSORIES
PAG. 21

TECHNICAL DATA

MODEL	CODE	ELECTRICAL DATA				HYDRAULIC DATA														
		VOLTAGE	P1 MAX kW	P2 NOMINAL		In A	Q=GPM	0	2.6	5.3	7.9	10.6	13.2	15.8	18.5	21.1	23.8	26.4	29	31.7
ESYBOX DIVER	60197922	1 x 220-240 V ~	1.3	0.95	1.3	5.5	H (ft)	180	180	180	180	180	180	174	144	112	85	56	25	
ESYBOX DIVER X	60202768	1 x 220-240 V ~	1.3	0.95	1.3	5.5	H (ft)	180	180	180	180	180	174	144	112	85	56	25		

APPLICATIONS



SUITABLE FOR PUMPING WATER FROM:



TANKS



RAINWATER COLLECTION TANKS



WELLS DOWN TO 26 FT DEEP

Esybox Diver

Houses and small residential buildings up to 6 floors and a maximum of 9 apartments.*

*Indicative data. Please refer to the technical catalogue or DNA for correct sizing.

ESYBOX DIVER

7" MULTISTAGE SUBMERSIBLE PUMPS WITH VARIABLE FREQUENCY DRIVE

RANGE PERFORMANCE

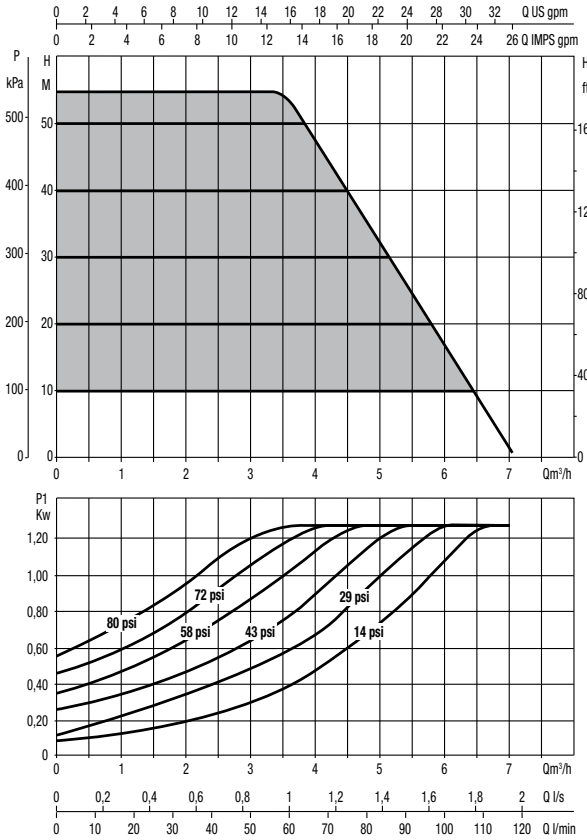

ESYBOX LINE

DIMENSIONS

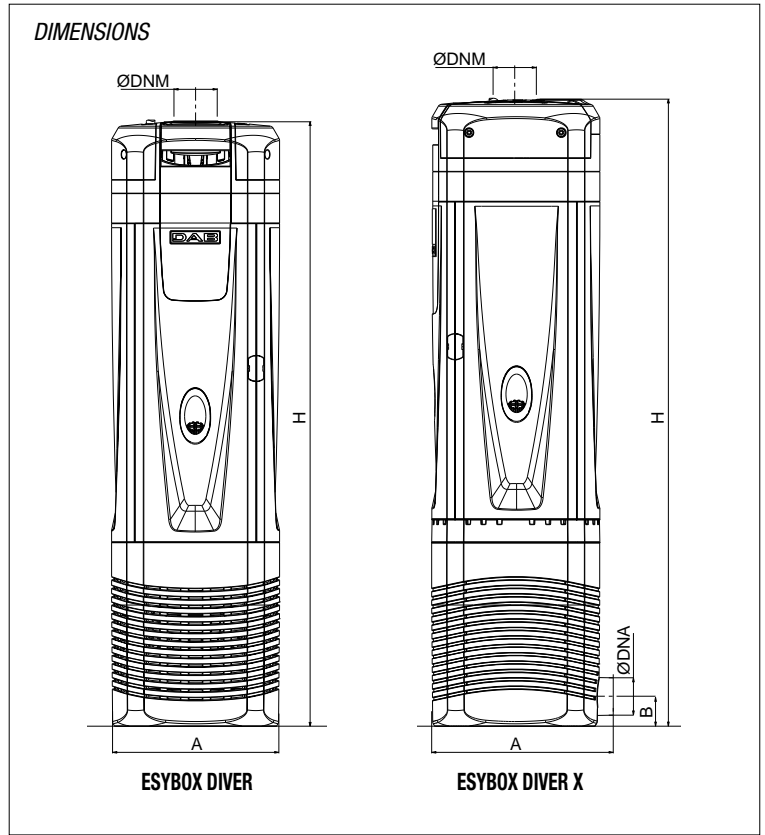









DIMENSIONS AND WEIGHTS

MODEL	A	B	H	Ø DNM NPT	Ø DNA NPT	PACKING DIMENSIONS			PACKING VOLUME ft³	Q.TY X PALLET	WEIGHT lbs
						L/A	L/B	H			
ESYBOX DIVER	7.3	-	25.6	1" 1/4	-	29.1	9.1	11.8	1.8	15	37.5
ESYBOX DIVER X	7.7	1.3	26.6	1" 1/4	1"	30.7	9.1	11.8	1.9	15	37.5

ESYBOX DIVER - ACCESSORIES

SUBMERSIBLE PUMPS AND SUBMERSIBLE MOTORS

	DESCRIPTION	CODE
    	<p>DCONNECT BOX 2</p> <p>Thanks to DConnect Box 2 and the new App you can check the pump, set the starting and stopping parameters, view the details of alarms and monitor the status of the system directly on your smartphone. (Only for DTron 3 and ESYBOX LINE products, included with Esybox Diver).</p>	<p>60198035 NEMA 5 PLUG to 120v NEMA 5/15P</p>
		<p>60198037 NEMA 6 PLUG to 230v NEMA 6/15P</p>
	<p>NFC WATER LEVEL MEASUREMENT</p> <p>Only connected to the DConnect Box 2, controls the level of water in the tank and notifies the user of the level via an App. (Only for DTron 3 and Esybox diver).</p>	60184570
	<p>NFC FLOAT</p> <p>Detects the level of water in a tank, preventing emptying of the latter and seizing of the pump avoiding the dry running, due to too low a level of water.</p>	60184577
	<p>DOC68</p> <p>The DOC68 permits installation of the DTron and Esybox Diver even outdoors as an IP68 certified surface pump.</p>	60192276

ESYBOX MAX

ELECTRONIC BOOSTER SET

NEW



esybox max

Integrated pumping system for water pressurization in commercial building service. Available in two power sizes, the system is composed of **modular elements** that allow different configurations: single, double, triple or quadruple unit are possible, to cover the needs of medium/large condominiums and high buildings (even over 14 floors). Each unit consists of the hydraulic connection base and the pumping unit which includes an electronic vertical multi-impeller pump, display, Wi-Fi module, pressure sensors, non-return valve on delivery and an expansion tank, **all integrated**.

The innovative support base of the pumping unit and the wireless communication between the pumps make it possible to **assemble the unit directly at the installation site (O.S.A. concept)** even by one person. The variable frequency drive keeps the pressure constant by varying the frequency of the motor according to the request and also thanks to the water-cooled permanent magnet motor it allows greater efficiency and energy savings. The large display allows easy configuration of the operating parameters with the possibility of viewing them from a smartphone (via the DConnect APP) or remotely via the DConnect service. The expansion module (esy I / O, available as an accessory) gives the possibility to interface Esybox max with the BMS.

- Flow rate** up to 76.6 GPM (single pump unit)
 - Head** 371 ft
 - Type of pumped liquid** clean, free from solid or abrasive substances, non-viscous, non-aggressive, non-crystallized and chemically neutral
 - Maximum liquid temperature** +122°F
 - Maximum room temperature** +131°F
 - Maximum inlet pressure** 73 psi
 - Nominal pressure (PN)** 174 psi
 - Constant pressure range** 15-174 psi (44 psi by default)
 - Motor protection class** IP X5
 - Motor insulation class** F
 - Impeller material** technopolymer
 - Single phase power input** 208-240 V 50/60 Hz
 - Three phase power input** 380-480 V 50/60 Hz
 - Type of installation** fixed in vertical position
 - Certification** NSF61.
- WRAS, ACS, CSA & UL pending approval



TECHNICAL DATA

MODEL (only pump unit)	CODE	ELECTRICAL DATA						DNA NPT	DNM NPT	WEIGHT lbs	Q.TY x PALLET
		N° IMPELLERS	VOLTAGE 50 - 60 Hz	P1 MAX		In A	SET POINT				
				kW	HP						
ESYBOX MAX 60/120 M	60199039	3	1x208-240 V ~	2.68	3.6	12.5-11.5	1-12	1"1/4 / 2"	1"1/4 / 2"	63.9	6
ESYBOX MAX 60/120 T	60199035	3	3x380-480 V ~	2.65	3.5	4.4	1-12	1"1/4 / 2"	1"1/4 / 2"	63.9	6
ESYBOX MAX 85/120 T	60195100	4	3x380-480 V ~	3.50	4.7	5.6	1-12	1"1/4 / 2"	1"1/4 / 2"	66.1	6

MODEL	CODE	WEIGHT lbs	Q.TY x PALLET
ESYDOCK MAX	60199045	19.8	12
2 ESYDOCK MAX	60199055	39.7	6
3 ESYDOCK MAX	60199056	59.5	3



APPLICATIONS

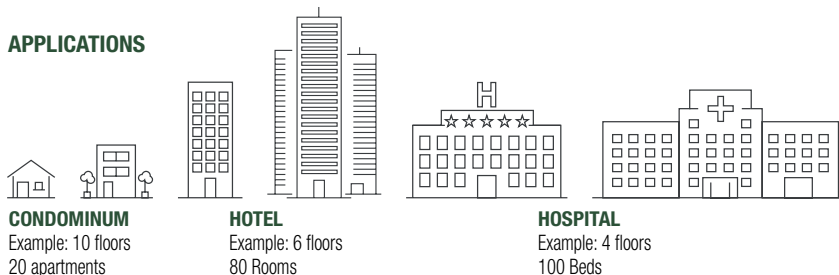

CONDOMINIUM
Example: 10 floors
20 apartments

HOTEL
Example: 6 floors
80 Rooms

HOSPITAL
Example: 4 floors
100 Beds

**SUITABLE FOR
PUMPING WATER FROM:
NO SELF-PRIMING**



discover



<https://esyboxline.com>

*Indicative data. Please refer to the technical catalogue or DNA for correct sizing.

ESYBOX MAX

ELECTRONIC BOOSTER SET

Efficiency at the state of the art

The DAB inverter has been combined with a brand new permanent magnet motor. We also designed completely new hydraulics, making it leap ahead in terms of energy efficiency.

20% 
Energy Saving

What about logistics

Esybox Max will improve the storage efficiency in your warehouse.

Where there was once one booster occupying space, you can now fit three in its place, that's three times more efficient!

This allows you to store the full range on one pallet, meaning your customer can pick up an off the shelf booster solution of up to 4 pumps the same day.



That's efficient!



1 PIECE OF 2KVC AD



6 PIECES OF ESYBOX MAX
+
3 PIECES OF 2ESYDOCK MAX



As quick as a "click"

Install Esydock into your pipework system and simply "plug" your pumps in. A final quick set up via the digital DConnect app completes your installation project.



ESYBOX MAX

ELECTRONIC BOOSTER SET



Easy to move & install

Keeping it flexible, we have the On-Site Assembly concept. So if you have difficulties getting to the pumps location, due to narrow stairways and corridors etc, you can choose to assemble your booster on-site which will only require moving smaller lighter boxes into the location then carry out our quick assembly steps.



ESYBOX LINE

D+CONNECT

Affordable web based remote control for your installation

You can use your smartphone to connect directly with the pump using the simple interface. It will automatically detect the language, time and unit of measurement at the installation site, which will save you time during the first set up of the system.

All adjustments are possible remotely allowing total control with no unwanted surprises. DConnect makes monitoring DAB products easy and intuitive.



D+CONNECT









BUILT-IN



ESYBOX MAX

ELECTRONIC BOOSTER SET

CONFIGURATION TABLE

GROUP TOTAL (PUMP UNIT + DOCK)	PUMP UNIT			DOCK		
	MODEL	CODE	Q.TY PUMP UNIT	MODEL	CODE	Q.TY DOCK
 esybox max	ESYBOX MAX 60/120 M	60199039	1 PUMP UNIT 	ESYDOCK MAX	60199045	1 DOCK 
	ESYBOX MAX 60/120 T	60199035				
	ESYBOX MAX 85/120 T	60195100				
 2 esybox max *	ESYBOX MAX 60/120 M	60199039	2 PUMP UNITS 	2 ESYDOCK MAX	60199055	1 DOCK 
	ESYBOX MAX 60/120 T	60199035				
	ESYBOX MAX 85/120 T	60195100				
 3 esybox max	ESYBOX MAX 60/120 M	60199039	3 PUMP UNITS 	3 ESYDOCK MAX	60199056	1 DOCK 
	ESYBOX MAX 60/120 T	60199035				
	ESYBOX MAX 85/120 T	60195100				

* With 2 Units of 2 Esybox Max with the JOINT KIT you obtain the 4 pump units group.

**DIMENSIONS
(PUMP UNIT + DOCK)
30.3 x 15 x 15 in**



SOUND PRESSURE
63 db(A)**

**DIMENSIONS (ONLY DOCK)
9.1 x 15 x 15 in**

esybox max

**DIMENSIONS
(PUMP UNIT + DOCK)
30.3 x 31.9 x 15 in**



**DIMENSIONS (ONLY DOCK)
9.1 x 31.9 x 15 in**

2 esybox max *

**DIMENSIONS
(PUMP UNIT + DOCK)
30.3 x 49.2 x 15 in**



**DIMENSIONS (ONLY DOCK)
9.1 x 49.2 x 15 in**

3 esybox max *

* To configure the 2/3/4 Esybox Max version you can combine the control panel and the pillar kit to facilitate the electrical sectioning of the pumps.

** Sound pressure measured at 3 ft distance in free field. 13.2GPM and 87 psi.

ESYBOX MAX

ELECTRONIC BOOSTER SET

RANGE PERFORMANCE

ESYBOX LINE

MODEL	Q=GPM	0	10.6	15.8	21.1	26.4	31.7	37	42.2	47.5	55.4	63.4	76.6
ESYBOX MAX 60/120 M	H (ft)	262	261	253	241	225	203	182	158	135	100	69	13
ESYBOX MAX 60/120 T		262	261	253	241	225	203	182	158	135	100	69	13
ESYBOX MAX 85/120 T		371	361	349	331	305	276	246	215	186	143	102	28

MODEL	Q=GPM	0	21.1	31.7	42.2	55.4	76.6	73.9	84.5	95	110.9	126.7	153.1
2 ESYBOX MAX 60/120 M	H (ft)	262	261	253	241	225	203	182	158	135	100	69	13
2 ESYBOX MAX 60/120 T		262	261	253	241	225	203	182	158	135	100	69	13
2 ESYBOX MAX 85/120 T		371	361	349	331	305	276	246	215	186	143	102	28

MODEL	Q=GPM	0	31.7	47.5	63.4	79.2	95	110.9	126.7	142.6	166.3	190.1	229.7
3 ESYBOX MAX 60/120 M	H (ft)	26	261	253	241	225	203	182	158	135	100	69	13
3 ESYBOX MAX 60/120 T		262	261	253	241	225	203	182	158	135	100	69	13
3 ESYBOX MAX 85/120 T		371	361	349	331	305	276	246	215	186	143	102	28

MODEL	Q=GPM	0	42.2	63.4	84.5	105.6	126.7	147,8	169	190.1	221.8	253.4	306.2
4 ESYBOX MAX 60/120 M	H (ft)	262	261	253	241	225	203	182	158	135	100	69	13
4 ESYBOX MAX 60/120 T		262	261	253	241	225	203	182	158	135	100	69	13
4 ESYBOX MAX 85/120 T		371	361	349	331	305	276	246	215	186	143	102	28

ESYBOX MAX

ELECTRONIC BOOSTER SET

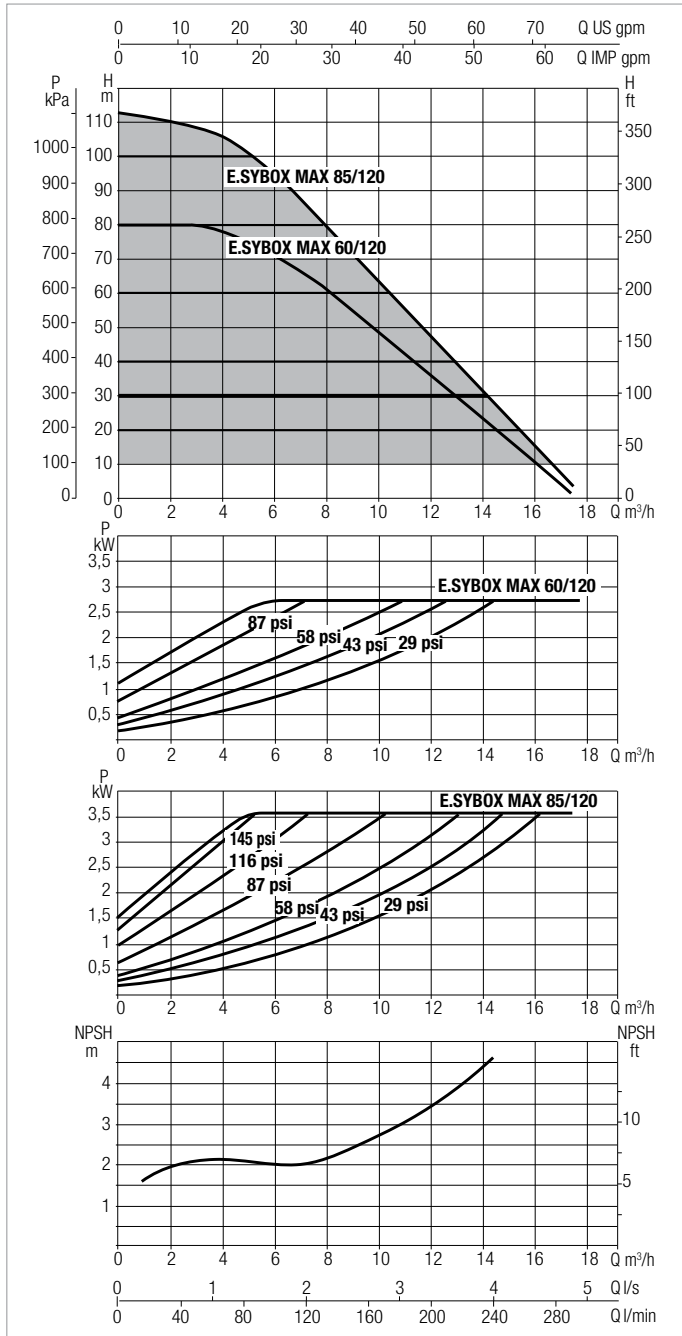

Curve tolerance according to ISO 9906.

DIMENSIONS

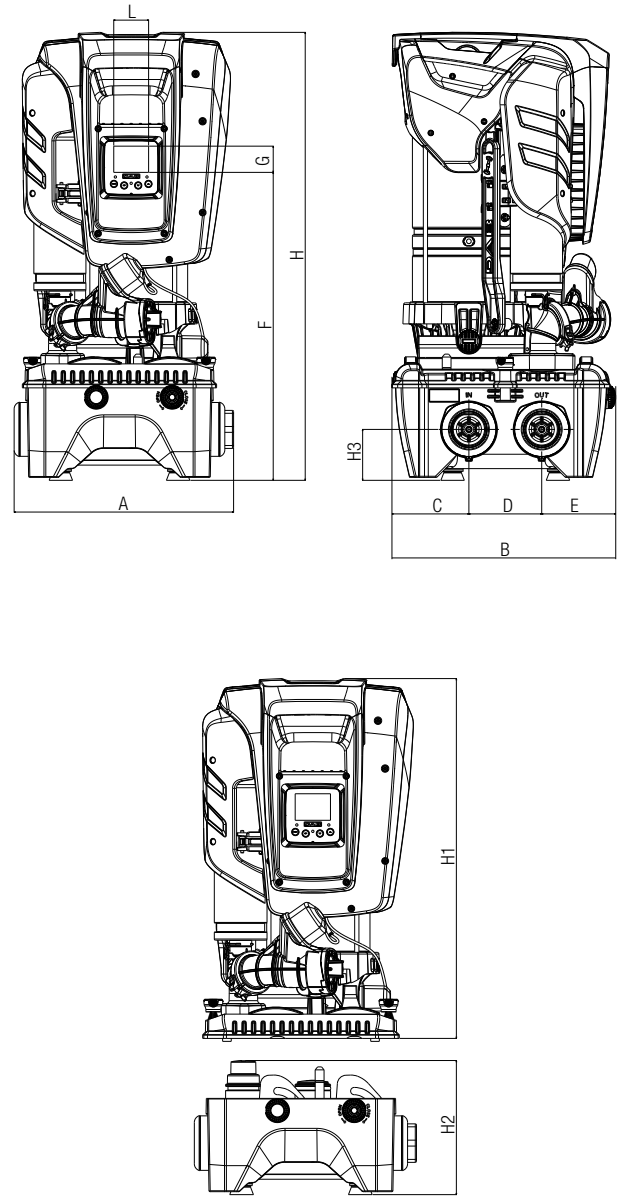

ESYBOX LINE

DIMENSIONS AND WEIGHTS

MODEL	A	B	C	D	E	F	G	H	H1	H2	H3	L	DNA	DNM	PACKING DIMENSIONS*			WEIGHT* PUMP UNIT lbs	PACKING DIMENSIONS			WEIGHT DOCK lbs
															PUMP UNIT				DOCK			
															L/A	L/B	H		L/A	L/B	H	
ESYBOX MAX 60/120	14.8	15.1	5.2	4.9	5	20.7	1.8	30.2	24.1	9	3.4	2.3	1 1/4 - 2"	1 1/4 - 2"	15.7	15	31.5	63.9	15.7	15.7	9.8	19.8
ESYBOX MAX 85/120	14.8	15.1	5.2	4.9	5	20.7	1.8	30.2	24.1	9	3.4	2.3	1 1/4 - 2"	1 1/4 - 2"	15.7	15	31.5	66.1	15.7	15.7	9.8	19.8

*Weights and packaging dimensions refer to a pump unit

ESYBOX MAX

ELECTRONIC BOOSTER SET

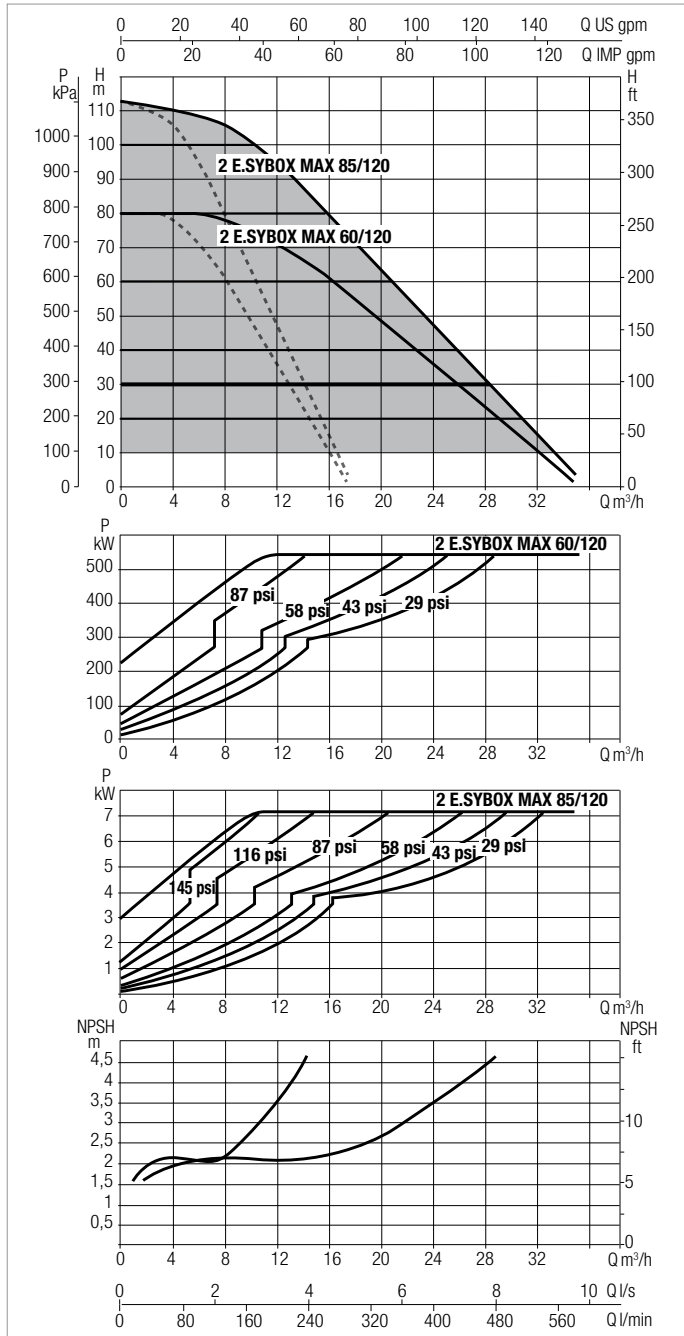

Curve tolerance according to ISO 9906.
For the four pumps version, the flow rate is the double.

DIMENSIONS

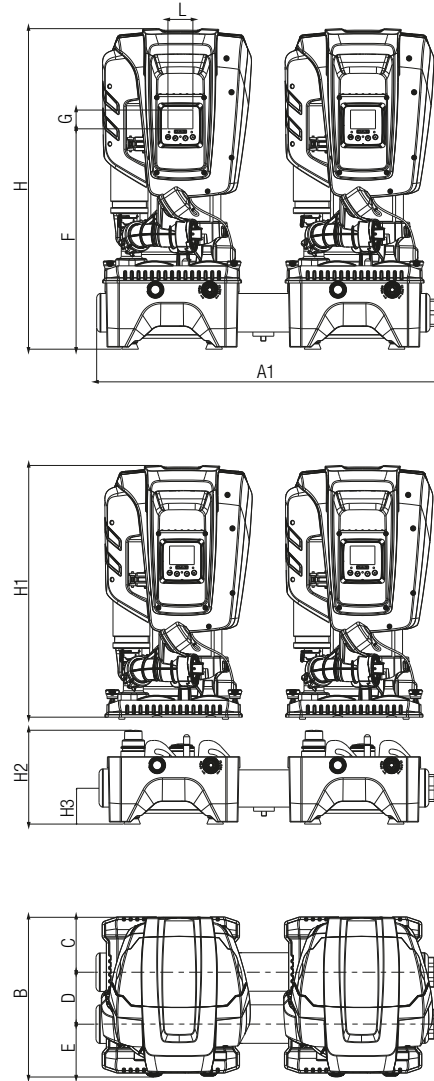

DIMENSIONS AND WEIGHTS

MODEL	A1	B	C	D	E	F	G	H	H1	H2	H3	L	DNA	DNM	PACKING DIMENSIONS*			WEIGHT* PUMP UNIT lbs	PACKING DIMENSIONS DOCK			WEIGHT DOCK lbs
															PUMP UNIT				DOCK			
															L/A	L/B	H	L/A	L/B	H		
2 ESYBOX MAX 60/120	31.9	15.1	5.2	4.9	5	20.7	1.8	30.2	24.1	9	3.4	2.3	2"	2"	15.7	15	31.5	63.9	35.4	15.7	9.8	39.7
2 ESYBOX MAX 85/120	31.9	15.1	5.2	4.9	5	20.7	1.8	30.2	24.1	9	3.4	2.3	2"	2"	15.7	15	31.5	66.1	35.4	15.7	9.8	39.7

*Weights and packaging dimensions refer to a pump unit **Control panel and Mounting bracket sold separately as optional accessories

ESYBOX MAX

ELECTRONIC BOOSTER SET

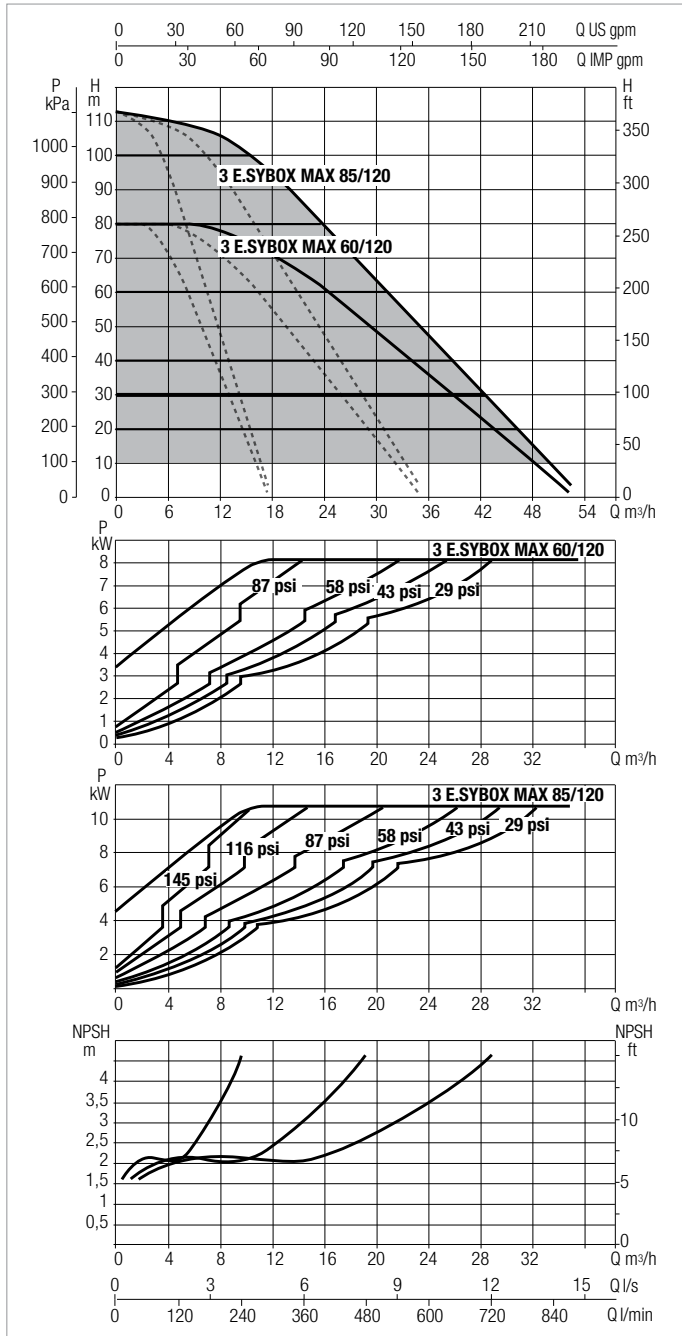

Curve tolerance according to ISO 9906.

DIMENSIONS

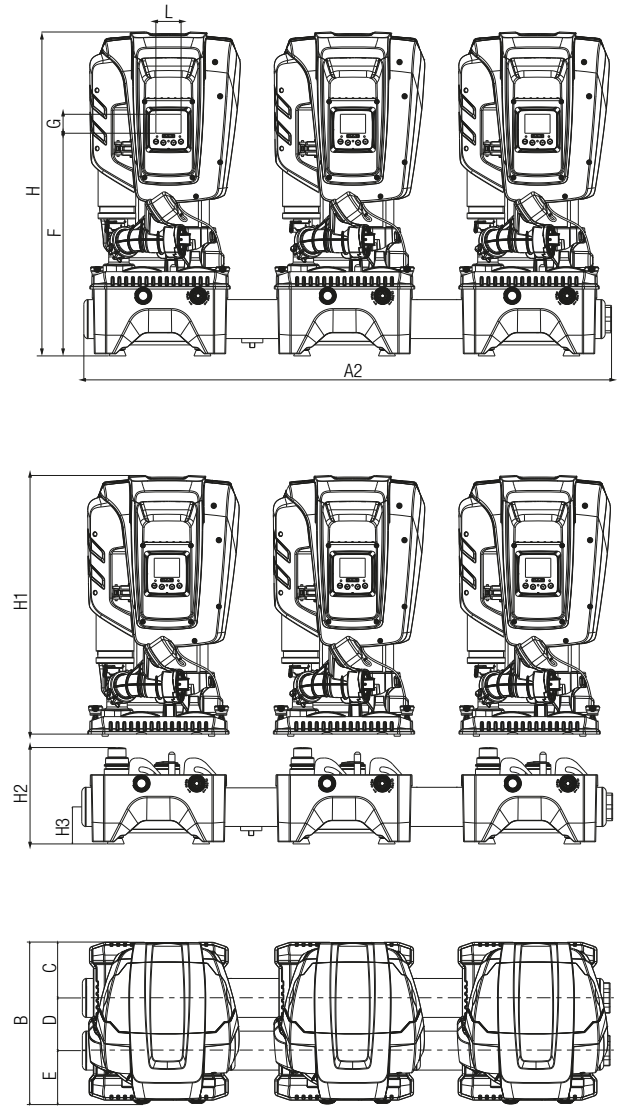

ESYBOX LINE

DIMENSIONS AND WEIGHTS

MODEL	A2	B	C	D	E	F	G	H	H1	H2	H3	L	DNA	DNM	PACKING DIMENSIONS*			WEIGHT* PUMP UNIT lbs	PACKING DIMENSIONS DOCK			WEIGHT DOCK lbs
															PUMP UNIT				DOCK			
															L/A	L/B	H		L/A	L/B	H	
3 ESYBOX MAX 60/120	49.2	15.1	5.2	4.9	5	20.7	1.8	30.2	24.1	9	3.4	2.3	2"	2"	15.7	15	31.5	63.9	49.2	15.7	9.8	59.5
3 ESYBOX MAX 85/120	49.2	15.1	5.2	4.9	5	20.7	1.8	30.2	24.1	9	3.4	2.3	2"	2"	15.7	15	31.5	66.1	49.2	15.7	9.8	59.5



*Weights and packaging dimensions refer to a pump unit **Control panel and Mounting bracket sold separately as optional accessories

ACCESSORIES ESYBOX LINE

ESYBOX - ACCESSORIES

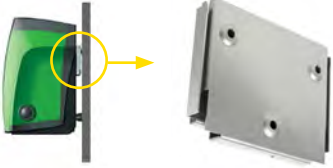
ELECTRONIC PRESSURIZATION SYSTEM

	DESCRIPTION	CODE
 <p>ALSO SUITABLE FOR ESYBOX MINI³</p>	<p>ESYWALL Kit complete with brackets, screws, dowels and two anti-vibration feet for absorption of vibrations.</p>	60161442

KIT OUTDOOR	MODEL	CODE
 <p>FOR ESYBOX</p>	<p>ESYCOVER KIT OUTDOOR ESYBOX Esyscover allows the installation of ESYBOX outside, protecting it from rain. Vertical installation only.</p>	60203667
 <p>FOR ESYBOX MINI³</p>	<p>ESYCOVER KIT OUTDOOR ESYBOX MINI³ Esyscover allows the installation of ESYBOX MINI³ outside, protecting it from rain. Vertical installation only.</p>	60203671

ESYCOVER

OUTSIDE INSTALLATION

Suitable for Esysbox mini³.



ESYCOVER

OUTSIDE INSTALLATION

Suitable for Esysbox.



ESYBOX MAX - ACCESSORIES

ELECTRONIC BOOSTER SET

	DESCRIPTION	CODE	ESYBOX MAX	2 ESYBOX MAX	3 ESYBOX MAX	4 ESYBOX MAX
	<p>ESY I/O</p> <p>The electronic expansion module allows Esybox Max to interface with the external input/output devices (eg: float switch, pressure switch, remote alarm) and with the BMS world (Building Management System).</p>	60200914	•	•	•	•



JETCOM - JET
SELF-PRIMING CENTRIFUGAL PUMPS

PAGE 36



EUROINOX
MULTISTAGE CENTRIFUGAL PUMPS

PAGE 49



JET PRESSURE SWITCH
CENTRIFUGAL PUMPS FITTED

PAGE 41



K
SINGLE IMPELLER CENTRIFUGAL PUMPS

PAGE 52



EI BOOSTER
MULTISTAGE CENTRIFUGAL PUMPS

PAGE 42



K
TWIN IMPELLERS CENTRIFUGAL PUMPS

PAGE 55



JETSS
SELF-PRIMING CENTRIFUGAL PUMPS

PAGE 45



DP
PUMPS FOR DEEP SUCTION

PAGE 58



JETSS PRESSURE SWITCH
CENTRIFUGAL PUMPS FITTED

PAGE 48

JETCOM - JET

SELF-PRIMING CENTRIFUGAL PUMPS



Self-priming centrifugal pump with excellent suction capacity even when there are air bubbles. Particularly suitable for water supply in domestic installations, small-scale agriculture, gardening and wherever self-priming operation is necessary.

Jetcom: technopolymer pump body.

Jet: cast iron pump body.

Motor support in cast iron, technopolymer impeller, diffuser, Venturi tube and sand guard. Stainless steel adjustment rings.

Carbon/ceramic mechanical seal. Asynchronous motor closed and cooled by external ventilation.

Built-in thermal and current overload protection and a capacitor permanently on in the single-phase version. For the protection of the three-phase motor it is advisable to use a suitable overload protection complying with the regulations in force.

Operating range two-poles from 1.8 to 46.2 GPM with head up to 203 ft

Liquid temperature range

from 32°F to +95°F for domestic use
from 32°F to +104°F for other use

Pumped liquid characteristics clean, free from solids or abrasive substances, non-viscous, non-aggressive, non-crystallised and chemically neutral.

Maximum ambient temperature +104°F

Maximum working pressure

87 psi for Jetcom and Jet

Protection level

IP 44 (IP 55 terminal board protection)

Insulation class F

TECHNICAL DATA - JETCOM

MODEL	CODE	ELECTRICAL DATA						
		VOLTAGE 60 Hz	P1 MÁX kW	P2 NOMINAL		In A	CAPACITOR	
				kW	HP		µF	Vc
JETCOM 82 M	60119499	1X115/230 V ~ dual VOLTAGE	0.93	0.5	0.8	8.21- 4.22	50	450
JETCOM 102 M	60119500	1X115/230 V ~ dual VOLTAGE	1.12	0.75	1	10.3- 5.25	50	450
JETCOM 132 M	60119501	1X115/230 V ~ dual VOLTAGE	1.57	1	1.36	14.7- 7.52	80	450

TECHNICAL DATA - JET

MODEL	CODE	ELECTRICAL DATA						
		VOLTAGE 60 Hz	P1 MÁX kW	P2 NOMINAL		In A	CAPACITOR	
				kW	HP		µF	Vc
JET 50	102668010.	1X115/230 V~	0.93	0.37	0.5	8.21- 4.22	50	450
JET 75	102668020.	1X115/230 V~	1.12	0.56	0.75	10.3- 5.25	50	450
JET 75-1	102668040.	1X115/230 V~	1.12	0.56	0.75	8.55- 4.33	50	250
JET 100	102668030.	1X115/230 V~	1.48	0.75	1	13.8 - 7.10	80	250
JET 100-1	102668050.	1X115/230 V~	1.48	0.75	1	13.8 - 7.10	80	250
JET 150	102166030.	1X230 V~	1.7	1.1	1.5	8	31.5	450
JET 200	102166040.	1X230 V~	2.4	1.5	2	11	40	450

JETCOM - JET

SELF-PRIMING CENTRIFUGAL PUMPS

RANGE PERFORMANCE

JETCOM 82 - JET 50

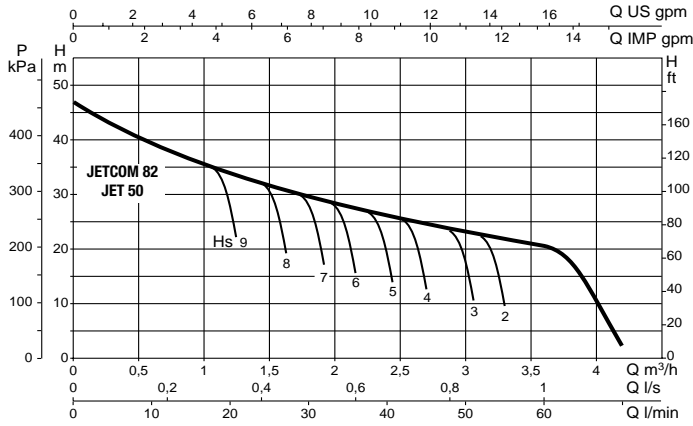

JETCOM 102 - JET 75

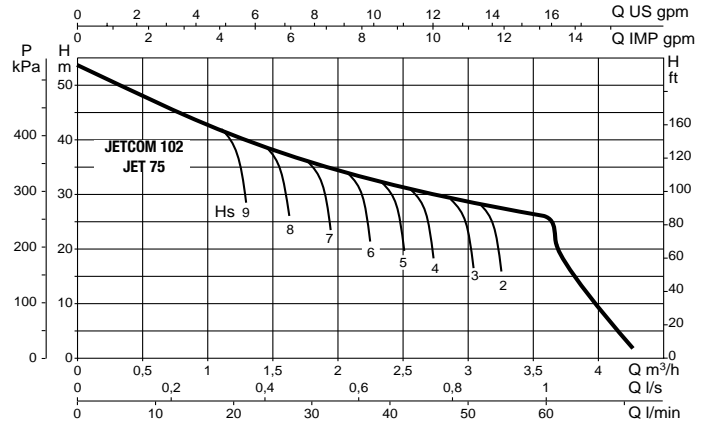

JET 75-1

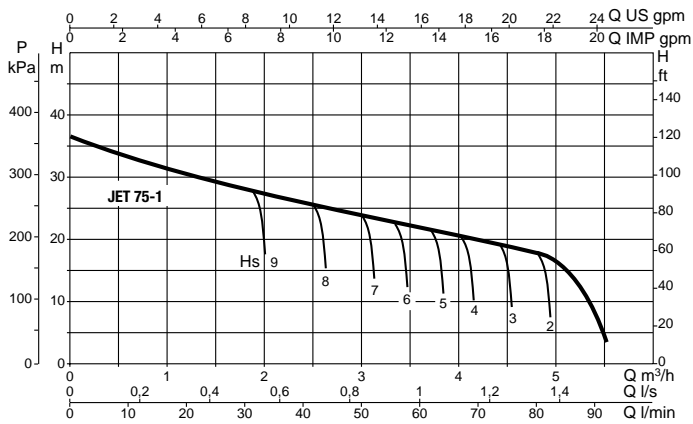

JET 100

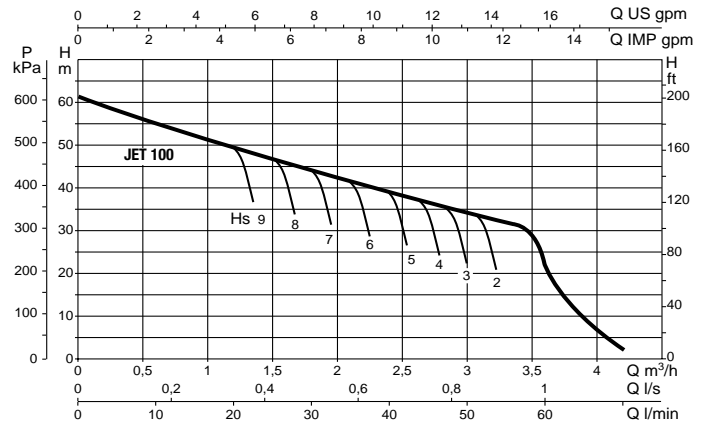

JETCOM 132 - JET 100-1

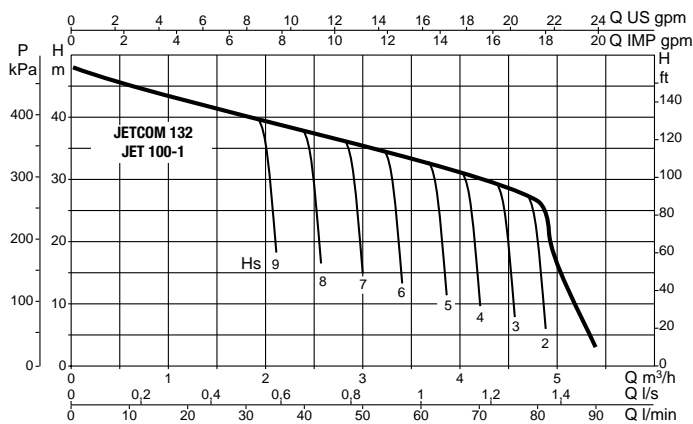

JET 150

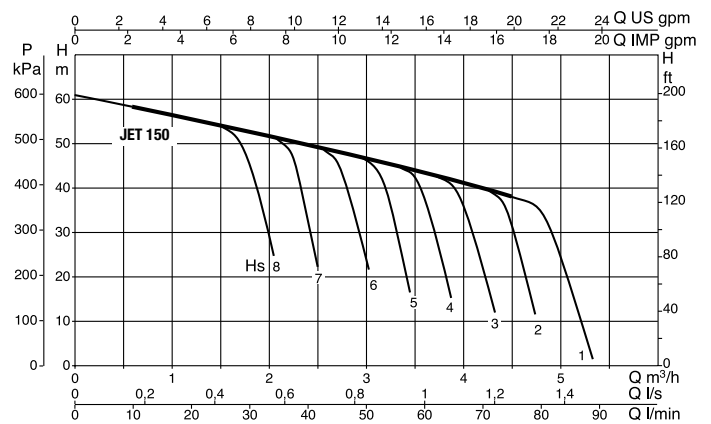

JETCOM - JET

SELF-PRIMING CENTRIFUGAL PUMPS

RANGE PERFORMANCE

JET 200

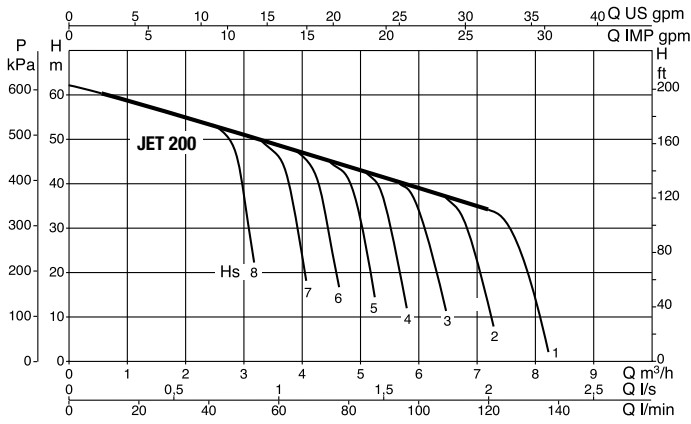

JETCOM - JET

MODEL	P2 NOMINAL		Q=(GPM)	H															
	kW	HP		0	2.6	5.3	7.9	10.6	13.2	15.8	18.5	21.1	26.4	31.7	39.6	42.2	46.2		
JETCOM 82 M	0.6	0.8	H (ft)	154	131	112	98	86	77	66									
JETCOM 102 M	0.75	1		177	154	135	119	106	94	85									
JETCOM 132 M	1	1.36		158	150	140	131	123	115	107	98	89							
JET 50	0.6	0.8		154	131	112	98	86	77	67									
JET 75	0.75	1		177	154	135	119	106	94	85									
JET 75-1	0.75	1		119	110	102	93	85	79	72	64	56							
JET 100	1	1.36		200	177	157	140	127	114	66									
JET 100-1	1	1.36		158	150	140	131	123	115	107	98	89							
JET 150	1.1	1.5		200	191	184	174	164	151	141	118								
JET 200	1.85	2.5		203	197	190	184	177	167	159	151	143	128	112					

JETCOM - JET

SELF-PRIMING CENTRIFUGAL PUMPS

RANGE PERFORMANCE

JET

MODEL	HP	DEPTH TO WATER	DISCHARGE PRESSURE											SHUT OFF PRESSURE
			15	20	25	30	35	40	45	50	55	60	65	
			FLOW GPM											
JET 50	1/2	5	14.8	14.8	14.7	13.6								62
		10	13.2	13.2	13.1	12.8								
		15		10.8	10.8	10.7	10.1							
		20			8.9	8.9	8.8	7.6						
		25			7	7	7	6.9	5.5					
JET 75	3/4	5	22.1	22.1	21.6								52	
		10	19.8	19.8	19.7									
		15	17.4	17.4	17.3	17.1								
		20		15.2	15.2	15.1								
		25	12.1	12.1	12	12	11.8							
JET 75-1	3/4	5			14.3	14.3	14.2	12.6					75	
		10			13.1	13.1	13	12.3						
		15				11	11	11	11					
		20				9.2	9.1	9.1	9					
		25					7	7	7	6.9				
JET 100	1	5	21.8	21.8	21.6	21.5	21.3						71	
		10	19.2	20.1	19.8	19.8	19.5	19.3						
		15	17.6	17.5	17.4	17.3	17.1	17						
		20		15.1	14.9	14.9	14.8	14.5	14.4					
		25		12	11.8	11.8	11.7	11.7	11.6	11.4				
JET 100-1	1	5				14.5	14.4	14.3	14.2				86	
		10					13.1	12.8	12.7	12.4				
		15						11.8	11.6	11.4	10.9			
		20							9.9	9.8	9.7	9.4		
		25									7.9	7.8		7.7
JET 150	1	5		21	20.9	20.7	20.6	20.3	20.2	19.9			87	
		10		19	18.8	18.5	18.2	17.9	17.8	17.5	17.3			
		15			15.7	15.5	15.4	15.2	15.1	15	14.8	14.5		
		20				13.3	13.1	12.9	12.7	12.5	12.4	12.1		11.9
		25					9.7	9.5	9.3	9.1	8.9	8.6		8.5
JET 200	1	5		31.8	31.6	31.2	30.8	30.5	30.1	29.1			85	
		10		28	27.7	27.6	27.2	26.9	26.7	26	25.1			
		15		23.6	23.3	23.2	23.1	22.8	22.5	22.3	22.1	20.9		
		20			20.2	19.9	19.8	19.7	19.4	19.3	19	18.5		17.3
		25					14.3	14.2	14.1	13.8	13.7	13.4		13.2

CENTRIFUGAL & JET



JETCOM - JET

SELF-PRIMING CENTRIFUGAL PUMPS

DIMENSIONS AND WEIGHTS

JETCOM

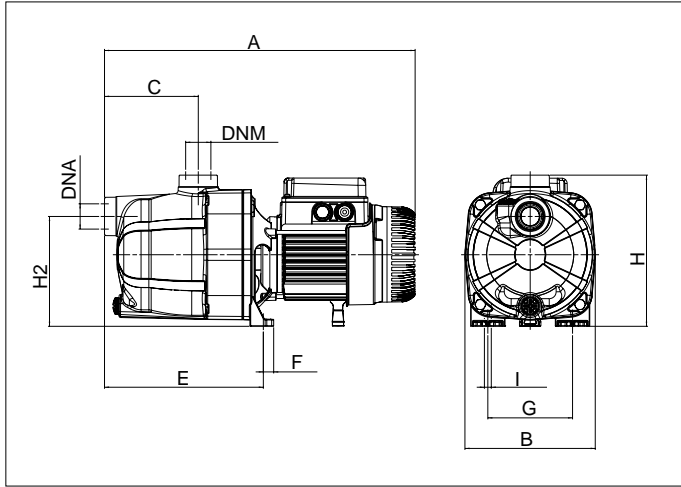

JET 50 - 75 - 75-1 - 100 - 100-1

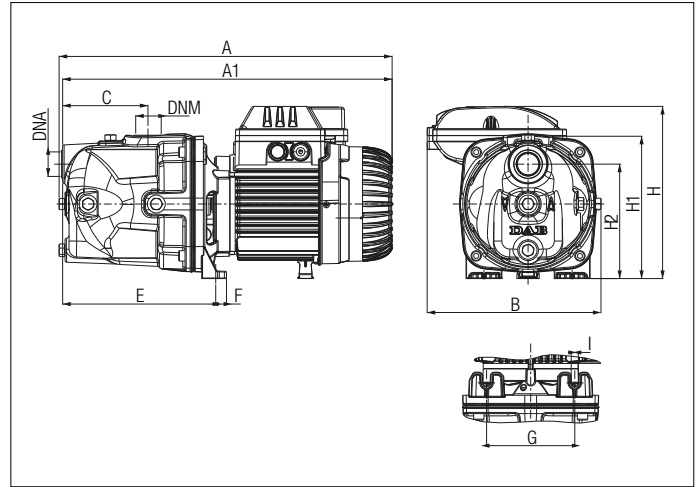

JET 150 - 200

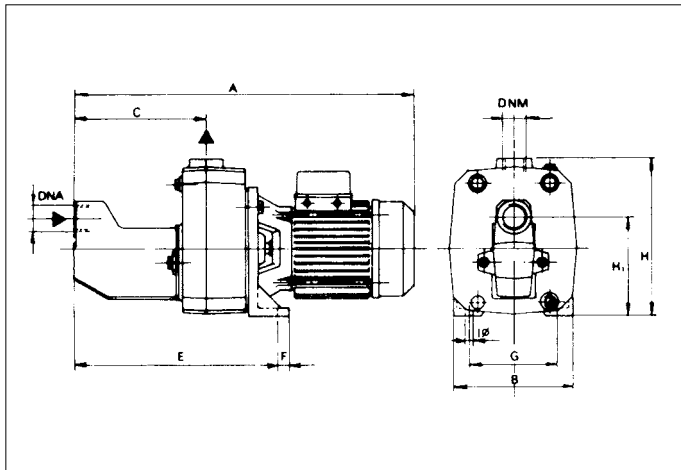

MODEL	A	A1	B	C	E	F	G	H	H1	H2	I Ø	DNA (NPT)	DNM (NPT)	L/A	L/B	H	WEIGHT lbs	Q.TY x PALLET
JETCOM 82	16	6.7	4.8	8.2	0.6	4.4	7.8	-	5.7	0.4	-	1"	1"	18.5	9.4	9.4	17	28
JETCOM 102	16.7	6.7	4.8	8.2	0.6	4.4	8	-	5.7	0.4	-	1"	1"	18.5	9.4	9.4	20.9	28
JETCOM 132 M	16.7	6.7	4.8	8.2	0.6	4.4	8	-	5.7	0.4	-	1"	1"	18.5	9.4	9.4	23.1	28
JET 50	15.6	15.5	8.6	4.2	7.6	0.6	4.4	8.1	-	5.7	0.4	1"	1"	18.5	9.4	9.4	23.6	28
JET 75	16.5	16.3	8.6	4.2	7.6	0.6	4.4	8.5	7	5.7	0.4	1"	1"	18.5	9.4	9.4	27.6	28
JET 75-1	15.6	15.4	7	4.3	7.6	0.6	4.4	7.6	-	5.7	0.4	1"	1"	18.5	9.4	9.4	25.8	28
JET 100	16.3	16.1	7	4.3	7.6	0.6	4.4	8	-	5.7	0.4	1"	1"	18.5	9.4	9.4	29.8	28
JET 100-1	16.3	16.1	10.4	4.3	7.6	0.6	4.4	8	-	5.7	0.4	1"	1"	18.5	9.4	9.4	29.8	28
JET 150	22	8.3	8.7	13.8	0.8	5.7	0.4	10	6,2	-	-	1 1/4"	1"	24.1	9.8	11	68.3	18
JET 200	24.9	8.3	8.7	13.8	0.8	5.7	0.4	10	6,2	-	-	1 1/4"	1"	25.9	9.8	11	77.2	15

JET PRESSURE SWITCH

CENTRIFUGAL PUMPS FITTED



JET 50-75-100 PS



JET 150-200 PS



JET 300 PS



C US

SINGLE-PHASE VERSION

Self-priming pump equipped with a pressure switch

THREE-PHASE VERSION

Available on request

Operating range

from 1.8 to 46.2 GPM with head up to 203 ft

Liquid quality requirements clean, free from solid or abrasive contaminants, non-viscous, non-aggressive, uncrystallised and chemically neutral, close to the properties of water.

Liquid temperature range from 32°F to +95°F for domestic use (EN 60335-2-41).
for other use: from 32°F to +104°F

Maximum ambient temperature +104°F

Maximum operating pressure 116 psi

Installation fixed in a horizontal position.

Special executions on request
different frequencies and/or voltage.

Motor protection rating IP 44

Terminal block protection rating IP 55

Insulation class F

TECHNICAL DATA

MODEL	CODE	ELECTRICAL DATA						
		VOLTAGE 60 Hz	P1 MÁX kW	P2 NOMINAL		In A	CAPACITOR	
				kW	HP		µF	Vc
JET 50-PS	102668110.	1X115/230 V~	0.93	0.37	0.5	8.21- 4.22	50	450
JET 75-PS	102668120.	1X115/230 V~	1.12	0.56	0.75	10.3 - 5.25	50	450
JET 75-1-PS	102668140.	1X115/230 V~	1.12	0.56	0.75	10.3 - 5.25	50	250
JET 100-PS	102668130.	1X115/230 V~	1.48	0.75	1	13.8 - 7.10	80	250
JET 100-1-PS	102668150.	1X115/230 V~	1.48	0.75	1	13.8 - 7.10	80	250
JET 150-PS	102166230.	1X230 V~	1.7	1.1	1.5	8	31.5	450
JET 200-PS	102166240.	1X230 V~	2.4	1.5	2	11	40	450
JET 300-PS	102166250.	1X230 V~	2.65	2.2	3	12	40	450

RANGE PERFORMANCE

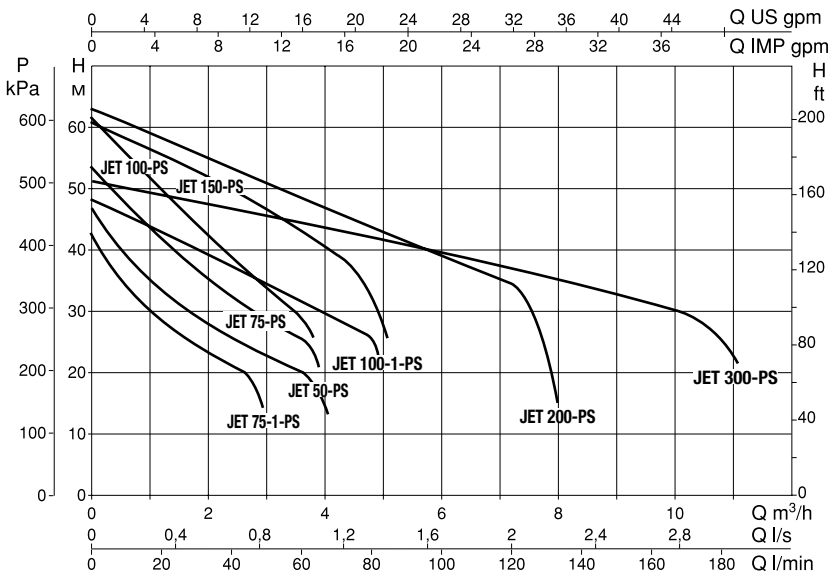

EI BOOSTER

MULTISTAGE CENTRIFUGAL PUMPS



EI BOOSTER



Horizontal centrifugal pump assembled with mascontrol for automatic operation.

Starts and stops the pump depending on opening and closing of the taps.

Stops the pump in case of a water shortage and protects it from dry running.

Is equipped with automatic restarts in case of failure and anti-jamming function.

No need for an expansion tank, check valve, filter or fittings.

Multistage horizontal centrifugal pump, featuring extremely silent running suitable for domestic use for water supply and pressurisation, irrigation of gardens and vegetable gardens, and moving water in general.

EI BOOSTER: stainless steel pump body.

Motor support in die-cast aluminium, seal holder in AISI 304 steel. Mechanical seal in carbon/ceramic. Rotor shaft in AISI 304 steel. Rotors, diffuser bodies and diffusers in technopolymer. Adjustment rings in stainless steel.

Protection level of motor IP 44

Protection level of terminal board IP 55

Insulation class F

Operating range from 2.6 to 31.7 GPM with a head of up to 236 ft

Pumped liquid characteristics clean, free from solid or abrasive substances, non-viscous, non-aggressive, non-crystallised, chemically neutral and close to the characteristics of water

Liquid temperature range from 32°F to +104°F for other uses.



Maximum ambient temperature +104°F

Maximum operating pressure 116 psi

EI booster self-priming

TECHNICAL DATA

MODEL	CODE	ELECTRICAL DATA						
		VOLTAGE 60 Hz	P1 MÁX kW	P2 NOMINAL		In A	CAPACITOR	
				kW	HP		µF	Vc
EI BOOSTER 30/50 M	TBD	1x115V	0.94	0.5	0.75	8.31-4.28	50	250
EI BOOSTER 40/50 M	TBD	1x115V	1.3	0.8	1.1	13.1-6.6	80	250
EI BOOSTER 50/50 M	TBD	1x115V	1.5	1	1.36	14.6-7.4	80	250
EI BOOSTER 40/80 M	TBD	1x115V	1.5	1	1.36	14.6-7.4	80	250

DEVICE FOR CONTROL AND PROTECTION OF THE PUMP	DESCRIPTION	MODEL	CODE
 <p>MASCONTROL</p>	<p>Can be used with either 115 Vac or 230 Vac. Starts and stops the pump depending on opening and closing of the taps. It has 1 1/4" male connections to guarantee a higher flow rate. Stops the pump in case of a water shortage and protects it from dry running. Is equipped with automatic restarts in case of failure and anti-jamming function. No need for an expansion tank, check valve, filter or fittings. Can be installed on surface and submersible pumps up to 16 amps Maintenance free.</p>	MCDV222101 1" 22 PS	109640400
		MCDV232101 1" 32 PS	109640410
		MCDV242101 1" 44 PS	109640420
		MCDV222114 1 1/4" 22 PSI	109640440
		MCDV232114 1 1/4" 32 PSI	109640450
		MCDV242114 1 1/4" 44 PSI	109640460
 <p>CONTROLPRESS</p>	<p>Can be used with either 115 Vac or 230 Vac. Starts and stops the pump depending on opening and closing of the taps. It allows to reduce the maximum pressure of the pump and to set the working pressure. Stops the pump in case of a water shortage and protects it from dry running. Is equipped with automatic restart in case of failure and anti-jamming function. No need for an expansion tank, check valve, filter or fittings. Can be installed on surface and submersible pumps up to 16 amps.</p>	MCDV114PR 1 1/4" 35-100 PSI	109640360

EI BOOSTER

MULTISTAGE CENTRIFUGAL PUMPS

RANGE PERFORMANCE

EI BOOSTER 50

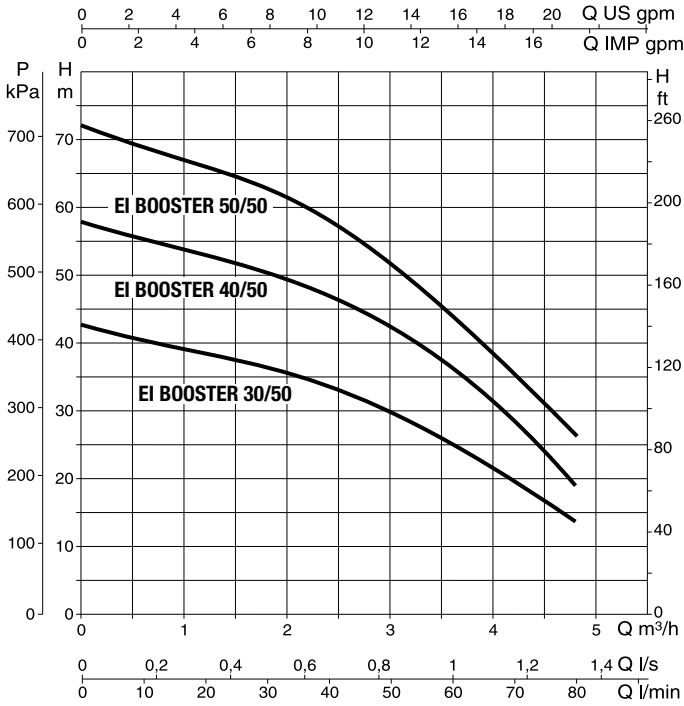

EI BOOSTER 80

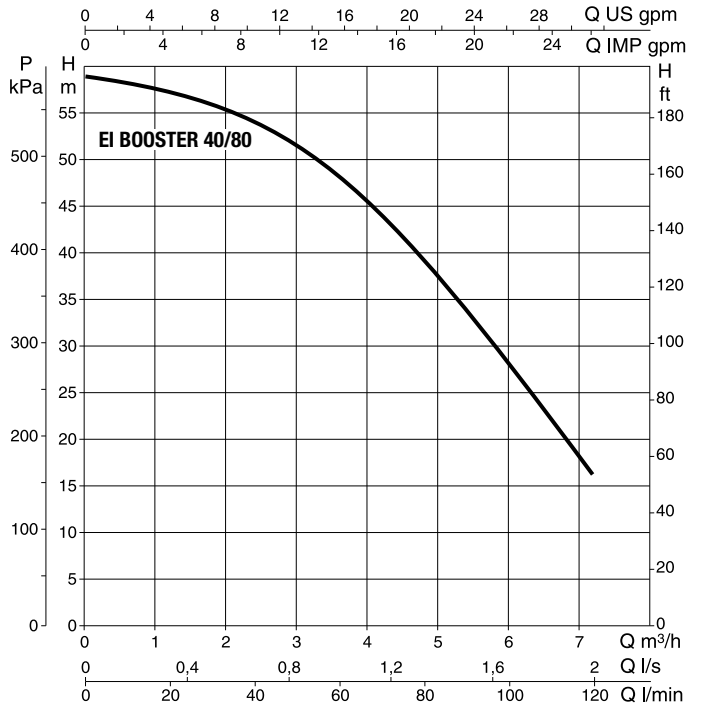

MODEL	P2 NOMINAL		Q=GPM	H (ft)														
	0	2.6		5.3	7.9	10.6	13.2	15.8	18.5	21.1	26.4	31.7	39.6	42.2	46.2			
EI BOOSTER 30/50 M - T	0.55	0.75	H (ft)	138	132	125	119	111	98	81	64	46						
EI BOOSTER 40/50 M - T	0.75	1		190	181	173	164	155	140	117	92	62						
EI BOOSTER 50/50 M - T	1	1.36		236	225	215	204	191	171	143	113	85						
EI BOOSTER 40/80 M - T	1	1.36		194		187	184	177	167	154	143	128	97	54				

EI BOOSTER

MULTISTAGE CENTRIFUGAL PUMPS

DIMENSIONS AND WEIGHTS

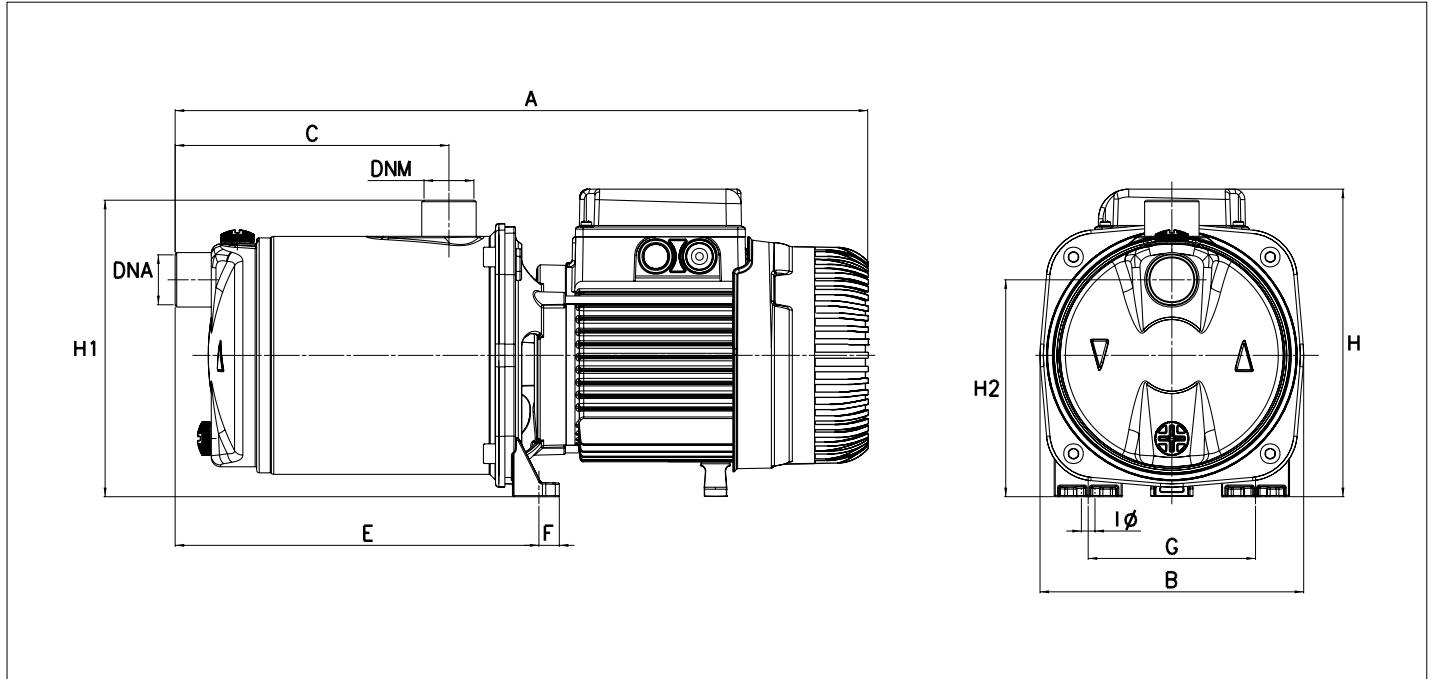

MODEL	A	B	C	E	F	G	IØ 4 Holes	H	H1	H2	DNA (NPT)	DNM (NPT)	PACKING DIMENSIONS			WEIGHT lbs	Q.TY x PALLET
													L/A	L/B	H		
EI BOOSTER 30/50	15.1	6.9	4.3	7.3	0.5	4.4	0.4	7.6	7.7	5.6	1"	1"	17.3	8.1	9.6	23.1	28
EI BOOSTER 40/50 M	18	6.9	6.5	9.5	0.5	4.4	0.4	8	7.7	5.6	1"	1"	18.9	8.3	10.4	32.2	28
EI BOOSTER 40/50 T	18.7	6.9	6.5	9.5	0.5	4.4	0.4	8	7.7	5.6	1"	1"	22	9.4	8.9	32.2	28
EI BOOSTER 50/50 M	18	6.9	6.5	9.5	0.5	4.4	0.4	8	7.7	5.6	1"	1"	18.9	8.3	10.4	33.3	28
EI BOOSTER 50/50 T	18.7	6.9	6.5	9.5	0.5	4.4	0.4	8	7.7	5.6	1"	1"	22	9.4	8.9	33.3	28
EI BOOSTER 40/80 M	18	6.9	6.5	9.5	0.5	4.4	0.4	8	7.7	5.6	1"	1"	18.9	8.3	10.4	33.3	28
EI BOOSTER 40/80 T	18.7	6.9	6.5	9.5	0.5	4.4	0.4	8	7.7	5.6	1"	1"	22	9.4	8.9	33.3	28

JETSS

SELF-PRIMING CENTRIFUGAL PUMPS



Self-priming centrifugal pump with excellent suction capacity even when there are air bubbles. Particularly suitable for water supply in domestic installations, small-scale agriculture, gardening and wherever self-priming operation is necessary.

JETSS: stainless steel pump body.

Motor support in cast iron, technopolymer impeller, diffuser, Venturi tube and sand guard. Stainless steel adjustment rings.

Carbon/ceramic mechanical seal. Asynchronous motor closed and cooled by external ventilation.

Built-in thermal and current overload protection and a capacitor permanently on in the single-phase version. For the protection of the three-phase motor it is advisable to use a suitable overload protection complying with the regulations in force.

Operating range two-poles from 1.8 to 46.2 GPM with head up to 203 ft

Liquid temperature range

from 32°F to +95°F for domestic use
from 32°F to +104°F for other use

Pumped liquid characteristics clean, free from solids or abrasive substances, non-viscous, non-aggressive, non-crystallised and chemically neutral

Maximum ambient temperature +104°F

Maximum working pressure 116 psi

Protection level

IP 44 (IP 55 terminal board protection)

Insulation class F

TECHNICAL DATA

MODEL	CODE	ELECTRICAL DATA						
		VOLTAGE 60 Hz	P1 MÁX kW	P2 NOMINAL		In A	CAPACITOR	
				kW	HP		µF	Vc
JETSS 50	102648010.	1X115/230 V~	0.93	0.37	0.5	8.21-4.22	50	450
JETSS 75	102648020.	1X115/230 V~	1.12	0.56	0.75	10.3-5.25	50	450
JETSS 75-1	102648040.	1X115/230 V~	1.12	0.56	0.75	10.3-5.25	50	250
JETSS 100	102648030.	1X115/230 V~	1.48	0.75	1	13.8-7.10	80	250
JETSS 100-1	102648050.	1X115/230 V~	1.48	0.75	1	13.8-7.10	80	250

JETSS

SELF-PRIMING CENTRIFUGAL PUMPS

RANGE PERFORMANCE

JETSS 50

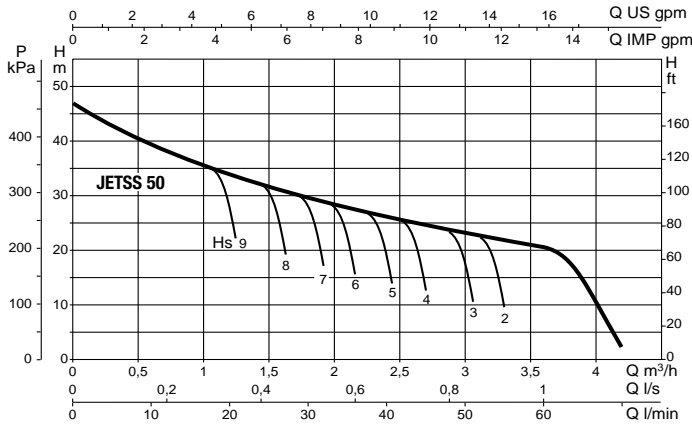

JETSS 75

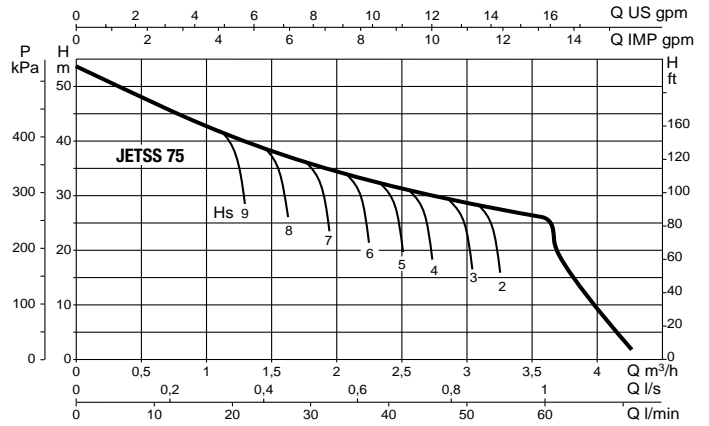

JETSS 75-1

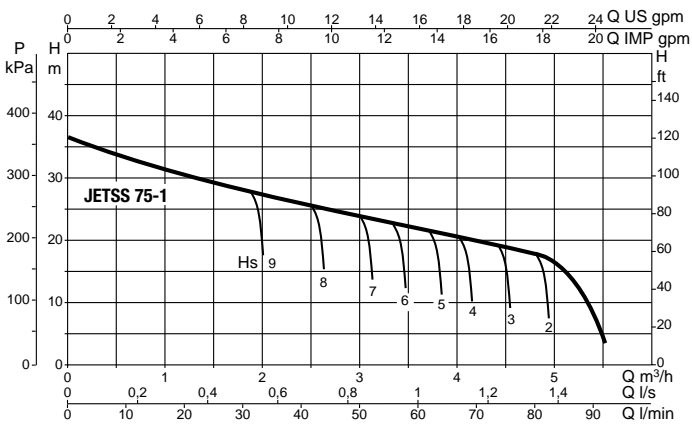

JETSS 100

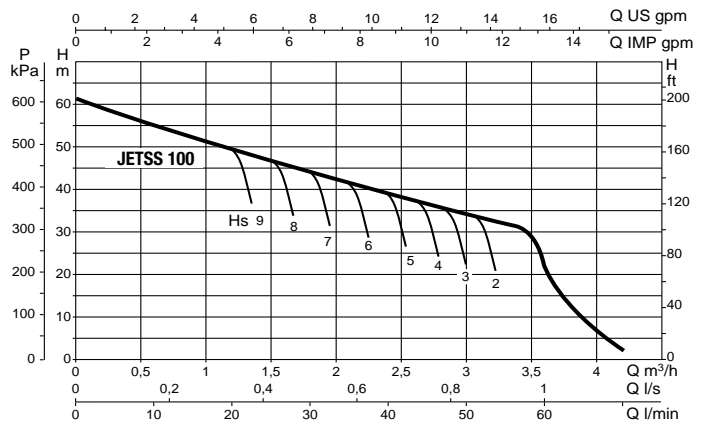

JETSS 100-1

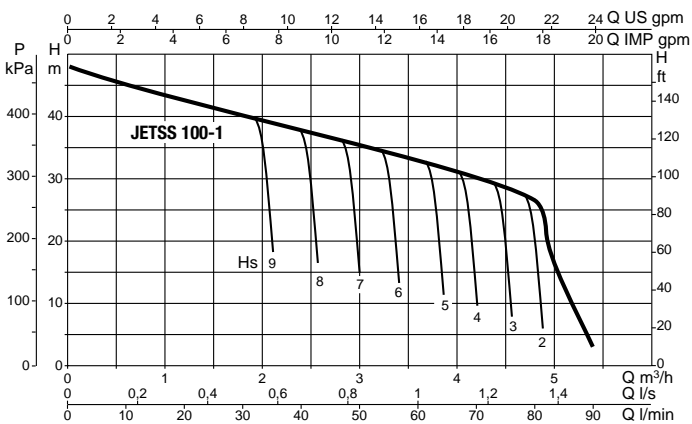

JETSS

SELF-PRIMING CENTRIFUGAL PUMPS

RANGE PERFORMANCE

MODEL	P2 NOMINAL		Q=GPM	H (ft)														
	KW	HP		0	2.6	5.3	7.9	10.6	13.2	15.8	18.5	21.1	26.4	31.7	39.6	42.2	10.5	
JETSS 50	0.6	0.8	H (ft)	154	131	112	98	86	77	67								
JETSS 75	0.75	1		177	154	135	119	106	94	85								
JETSS 75-1	0.75	1		119	110	102	93	85	79	72	64	57						
JETSS 100	1	1.36		200	177	157	140	127	114	66								
JETSS 100-1	1	1.36		158	150	140	131	123	115	107	98	89						

DIMENSIONS AND WEIGHTS

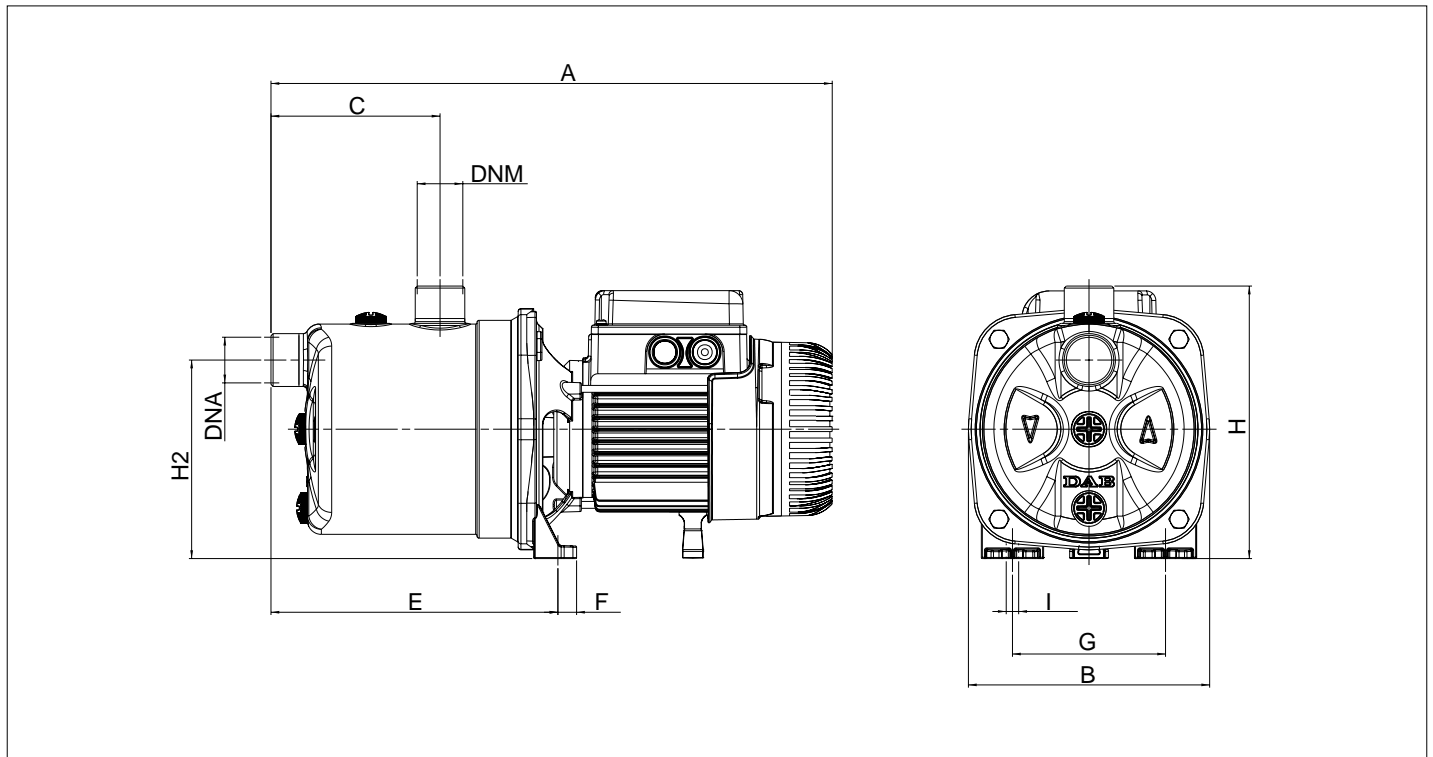

MODEL	A	A1	B	C	E	F	G	H	H1	H3	I Ø	DNA (NPT)	DNM (NPT)	L/A	L/B	H	WEIGHT lbs	Q.TY x PALLET
JETSS 50	16	6.9	4.8	8.1	0.6	4.4	7.8	-	5.7	0.4	-	1"	1"	18.5	9.4	9.4	17.2	28
JETSS 75	16.7	6.9	4.8	8.1	0.6	4.4	7.8	-	5.7	0.4	-	1"	1"	18.5	9.4	9.4	21.2	28
JETSS 75-1	16	6.9	4.8	8.1	0.6	4.4	7.8	-	5.7	0.4	-	1"	1"	18.5	9.4	9.4	19.4	28
JETSS 100	16.7	6.9	4.8	8.1	0.6	4.4	7.8	-	5.7	0.4	-	1"	1"	18.5	9.4	9.4	23.4	28
JETSS 100-1	16.7	6.9	4.8	8.1	0.6	4.4	7.8	-	5.7	0.4	-	1"	1"	18.5	9.4	9.4	23.4	28

JETSS PRESSURE SWITCH

CENTRIFUGAL PUMPS FITTED

SINGLE-PHASE VERSION

Self-priming pump equipped with a pressure switch,.

THREE-PHASE VERSION

Available on request.



Operating range

from 1.8 to 46.2 GPM with head up to 203 ft

Liquid quality requirements clean, free from solid or abrasive contaminants, non-viscous, non-aggressive, uncrystallised and chemically neutral, close to the properties of water

Liquid temperature range from 32°F to +95°F for domestic use (EN 60335-2-41)
for other use: from 32°F to +104°F

Maximum ambient temperature +104°F

Maximum operating pressure 116 psi

Installation fixed in a horizontal position

Special executions on request
different frequencies and/or voltage

Motor protection rating IP 44

Terminal block protection rating IP 55

Insulation class F

Standard input voltage

single phase 110/127 - 220/240 V / 60 Hz

three phase 230/460 V - 60 Hz ON REQUEST



TECHNICAL DATA

MODEL	CODE	ELECTRICAL DATA						
		VOLTAGE 60 Hz	P1 MÁX kW	P2 NOMINAL		In A	CAPACITOR	
				kW	HP		µF	Vc
JETSS 50-PS	102648110.	1X115/230 V~	0.93	0.37	0.5	8.21-4.22	50	450
JETSS 75-PS	102648120.	1X115/230 V~	1.12	0.56	0.75	10.3-5.25	50	450
JETSS 75-1-PS	102648140.	1X115/230 V~	1.12	0.56	0.75	10.3-5.25	50	250
JETSS 100 -PS	102648130.	1X115/230 V~	1.48	0.75	1	13.8-7.10	80	250
JETSS 100-1 -PS	102648150.	1X115/230 V~	1.48	0.75	1	13.8-7.10	80	250

RANGE PERFORMANCE

MODEL	Q=GPM	0	2.6	5.3	7.9	10.6	13.2	15.8	18.5	21.1
JETSS 50-PS	H (ft)	154	131	112	98	86	77	67	0	0
JETSS 75-PS		177	154	135	119	106	94	85	0	0
JETSS 75-1-PS		119	110	102	93	85	79	72	64	56
JETSS 100 -PS		200	177	157	140	127	114	66	0	0
JETSS 100-1 -PS		158	150	140	131	123	115	107	98	89

EUROINOX

MULTISTAGE CENTRIFUGAL PUMPS



Multistage horizontal centrifugal pump, featuring extremely silent running suitable for domestic use for water supply and pressurisation, irrigation of gardens and vegetable gardens, and moving water in general.

Euroinox: stainless steel pump body.

Motor support in die-cast aluminium, seal holder in AISI 304 steel. Mechanical seal in carbon/ceramic. Rotor shaft in AISI 304 steel. Rotors, diffuser bodies and diffusers in technopolymer. Adjustment rings in stainless steel.

Protection level of motor IP 44

Protection level of terminal board IP 55

Insulation class F

Operating range from 2.6 to 31.7 GPM with a head of up to 236 ft

Pumped liquid characteristics clean, free from solid or abrasive substances, non viscous, non aggressive, non crystallised, chemically neutral and close to the characteristics of water

Liquid temperature range

from 32°F to +95°F for domestic use

(EN 60335-2-41)

from 32°F to +104°F for other uses

Maximum ambient temperature +104°F

Maximum operating pressure 116 psi

Euroinox self-priming



TECHNICAL DATA

MODEL	CODE	ELECTRICAL DATA						
		VOLTAGE 60 Hz	P1 MÁX kW	P2 NOMINAL		In A	CAPACITOR	
				kW	HP		µF	Vc
EUROINOX 30/306 M	60119512	1X115/230 V~ dual VOLTAGE	0.89	0.33	0.6	8.0- 4.12	50	250
EUROINOX 40/306 M	60119513	1X115/230 V~ dual VOLTAGE	1	0.5	0.75	8.92- 4.55	50	250
EUROINOX 30/506 M	60119514	1X115/230 V~ dual VOLTAGE	0.94	0.5	0.75	8.31- 4.28	50	250
EUROINOX 40/506 M	60119515	1X115/230 V~ dual VOLTAGE	1.3	0.8	1.1	13.0- 6.6	80	250
EUROINOX 50/506 M	60119516	1X115/230 V~ dual VOLTAGE	1.5	1	1.36	14.6- 7.4	80	250
EUROINOX 25/806 M	60119517	1X115/230 V~ dual VOLTAGE	0.9	0.55	0.75	8.3- 4.3	50	250
EUROINOX 30/806 M	60119518	1X115/230 V~ dual VOLTAGE	1.3	0.8	1.1	13.0- 6.5	80	250
EUROINOX 40/806 M	60119519	1X115/230 V~ dual VOLTAGE	1.5	1.1	1.36	14.6- 7.4	80	250

EUROINOX

MULTISTAGE CENTRIFUGAL PUMPS

RANGE PERFORMANCE

EUROINOX 30

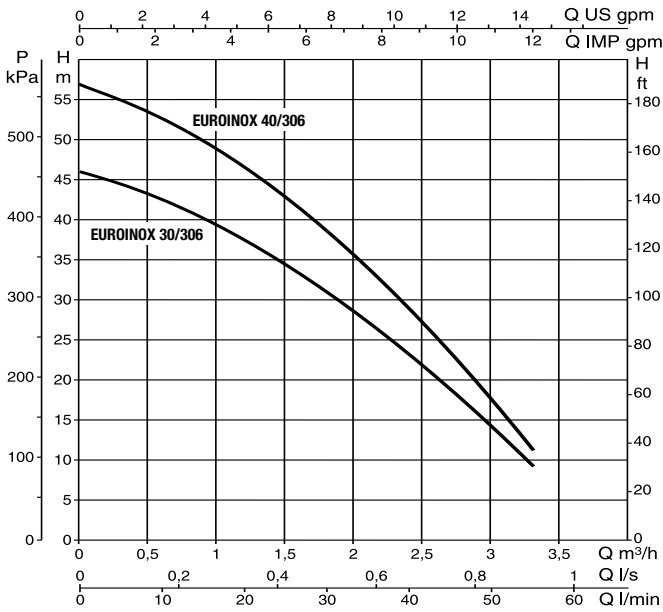

EUROINOX 50

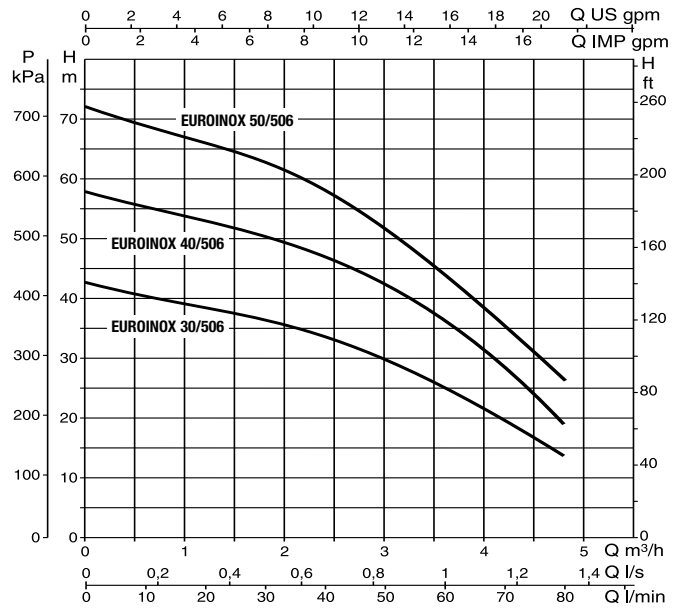

EUROINOX 80

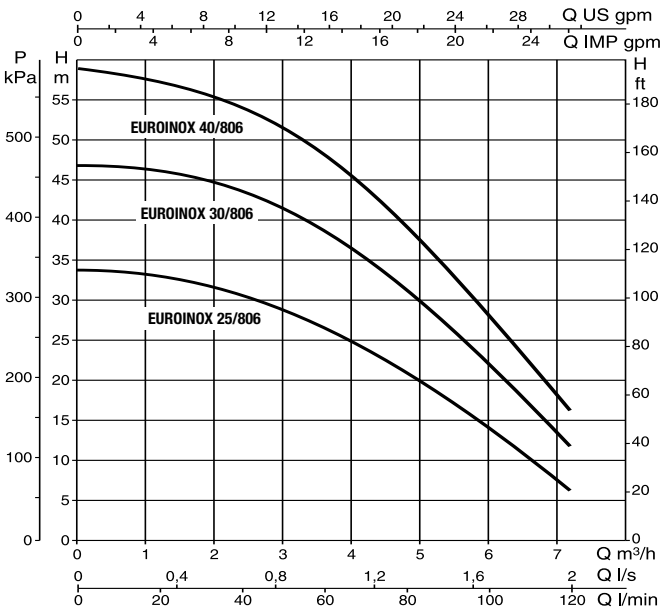

EUROINOX

MULTISTAGE CENTRIFUGAL PUMPS

RANGE PERFORMANCE

MODEL	P2 NOMINAL		Q=GPM	H													
	kW	HP		0	2.6	5.3	7.9	10.6	13.2	15.8	18.5	21.1	26.4	31.7			
EUROINOX 30/306 M	0.45	0.6	H (ft)	151	138	124	102	76	47								
EUROINOX 40/306 M	0.55	0.75		187	173	154	127	95	58								
EUROINOX 30/506 M	0.55	0.75		138	132	125	119	111	98	81	64	46					
EUROINOX 40/506 M	0.75	1		190	181	173	164	155	140	117	92	62					
EUROINOX 50/506 M	1	1.36		236	225	215	204	191	171	143	113	85					
EUROINOX 25/806 M	0.55	0.75		112		108	105	100	94	85	77	69	48	21			
EUROINOX 30/806 M	0.8	1.1		154		153	148	143	135	125	113	102	75	39			
EUROINOX 40/806 M	1	1.36		194		187	184	177	167	154	143	128	97	54			

DIMENSIONS AND WEIGHTS

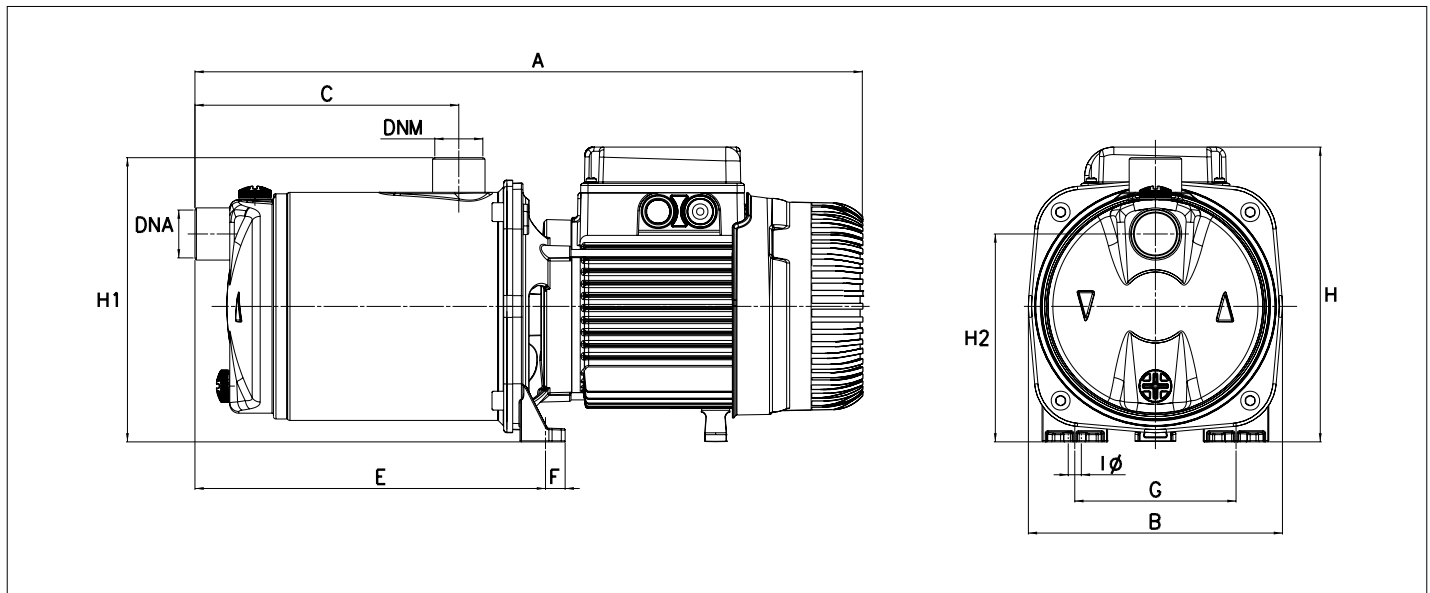

MODEL	A	B	C	E	F	G	∅ 4 Holes	H	H1	H2	DNA (NPT)	DNM (NPT)	PACKING DIMENSIONS			WEIGHT lbs	Q.TY x PALLET
													L/A	L/B	H		
EUROINOX 30/306 M	17.3	6.9	6.5	9.5	0.5	4.4	0.4	7.6	7.7	5.6	1"	1"	18.9	8.3	10.4	25.8	28
EUROINOX 40/306 M	17.3	6.9	6.5	9.5	0.5	4.4	0.4	7.6	7.7	5.6	1"	1"	18.9	8.3	10.4	26.2	28
EUROINOX 30/506 M	15.1	6.9	4.3	7.3	0.5	4.4	0.4	7.6	7.7	5.6	1"	1"	17.3	8.1	9.6	23.1	28
EUROINOX 40/506 M	18	6.9	6.5	9.5	0.5	4.4	0.4	8	7.7	5.6	1"	1"	18.9	8.3	10.4	32.2	28
EUROINOX 50/506 M	18	6.9	6.5	9.5	0.5	4.4	0.4	8	7.7	5.6	1"	1"	18.9	8.3	10.4	33.3	28
EUROINOX 25/806 M	15.1	6.9	4.3	7.3	0.5	4.4	0.4	7.6	7.7	5.6	1"	1"	17.3	8.1	9.6	23.1	28
EUROINOX 30/806 M	18	6.9	6.5	9.5	0.5	4.4	0.4	8	7.7	5.6	1"	1"	18.9	8.3	10.4	32.2	28
EUROINOX 40/806 M	18	6.9	6.5	9.5	0.5	4.4	0.4	8	7.7	5.6	1"	1"	480	212	265	15.1	28

K

SINGLE IMPELLER CENTRIFUGAL PUMPS



K 35/1200 T

Single impeller centrifugal pump suitable for domestic, civil, industrial and agricultural installations and for decanting, mixing and irrigating uses. Cast iron pump body and motor support. Technopolymer impeller. Stainless steel driving shaft. Carbon/ceramic mechanical seal. Asynchronous, closed motor, cooled by external ventilation. Built-in thermal and current overload protection and a capacitor permanently on in the single-phase version. For the protection of the three-phase motor it is advisable to use a suitable overload protection complying with the regulations in force.

Operating range from 7.9 to 422.7 GPM with head up to 203 ft

Pumped liquid characteristics clean, free from solids or abrasive substances, non-viscous, non-aggressive, non-crystallised, chemically neutral and close to the characteristics of water

Liquid temperature range from 14°F to +122°F

Maximum operating range 87 psi

Maximum ambient temperature +104°F

Protection level IP 44

Terminal board protection level IP 55

Insulation class F



TECHNICAL DATA

MODEL	CODE	ELECTRICAL DATA						
		VOLTAGE 60 Hz	P1 MAX kW	P2 NOMINAL		In A	CAPACITOR	
				kW	HP		µF	Vc
K 20/41 M	60113967	1x115/230 V~	0.8	0.37	0.5	6.7-3.5	40	250
K 30/70 M	60113968	1x115/230 V~	1.5	0.75	1	14.5-7.35	80	450
K 30/100 M	102115640	1x220-230 V~	1.72	1.1	1.5	8-7.6	31.5	450
K 36/100 M	102115700	1x220-230 V~	2.1	1.85	2.5	9.4-9	40	450

K

SINGLE IMPELLER CENTRIFUGAL PUMPS

RANGE PERFORMANCE

K 20/41

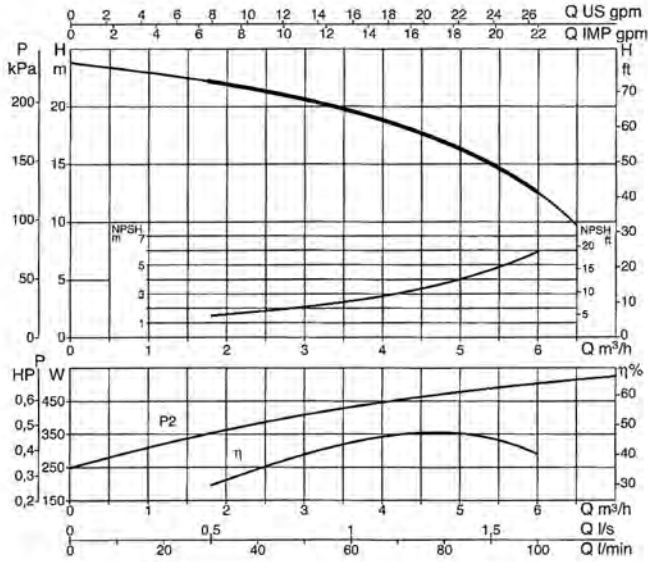

K 30/70

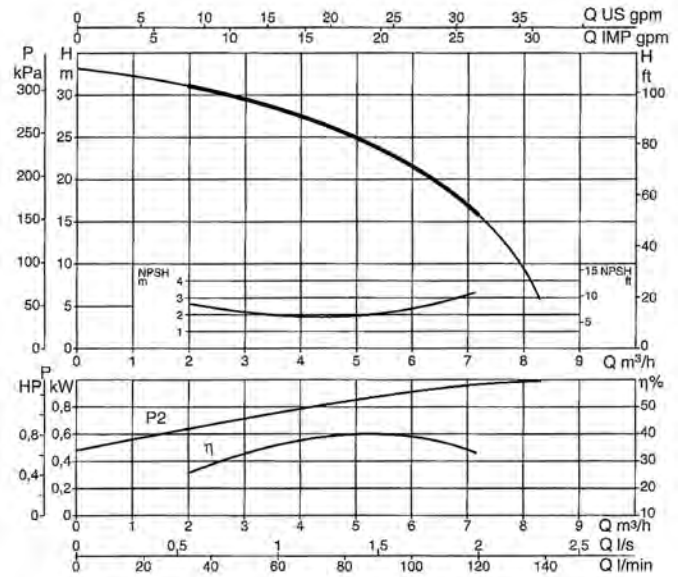

K 30/100

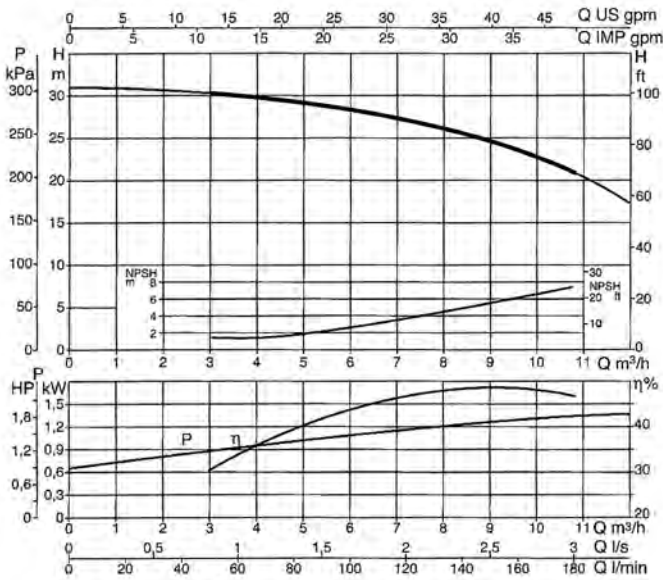

K 36/100

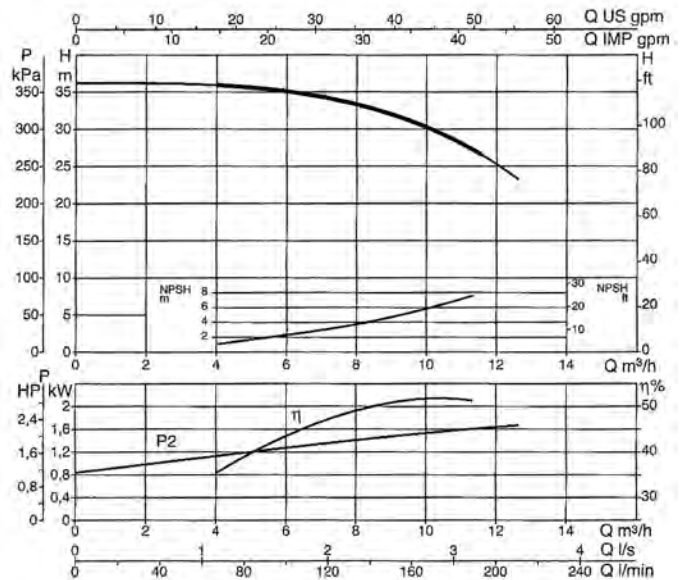

MODEL	P2 NOMINAL		Q= GPM	H (ft)												
	KW	HP		0	7.9	10.6	15.8	21.1	26.4	31.7	39.6	42.2	46.2	52.8		
K 20/41 M *	0.37	0.5	H (ft)	77	71	69	62	53	40	15						
K 30/70 M	1.5	0.75		108	102	100	94	87	75	62						
K 30/100 M	1.1	1.5		100		98	95	93	90	86	74	70	59	37		
K 36/100 M	1.85	2.5		117		116	115	114	111	106	98	94	85	70		

* pump not suitable for domestic application

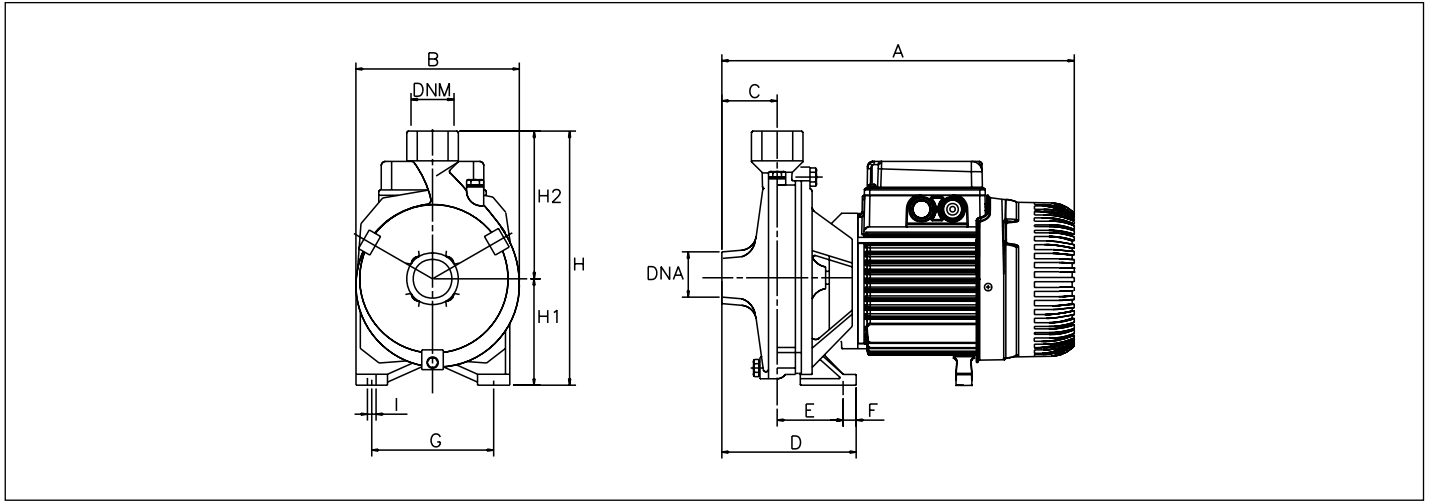
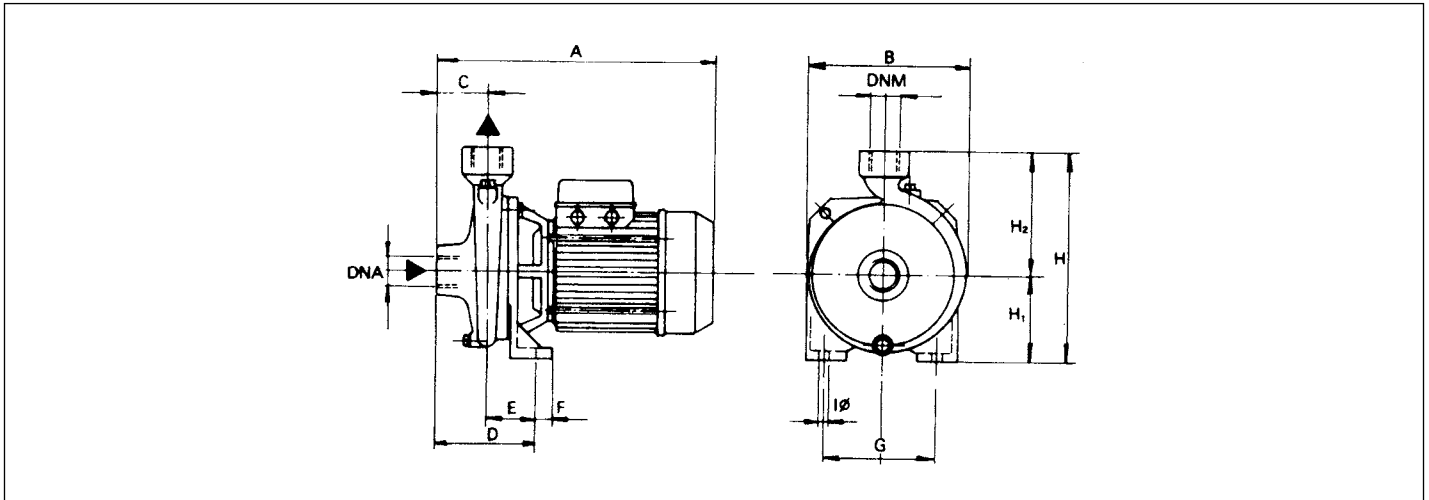
K**SINGLE IMPELLER CENTRIFUGAL PUMPS****DIMENSIONS AND WEIGHTS****K 20/41 - 30/70****K 30/100 - 36/100**

MODEL	A	B	C	D	E	F	G	I Ø	H	H1	H2	DNA			DNM			PACKAGING DIMENSIONS			VOLUME ft ³	WEIGHT lbs	Q.TY x PALLET
												X1	Y1	Z1	X2	Y2	Z2	L/A	L/B	H			
K 20/41 M	11.8	6.3	2	3.9	2	0.6	4.3	0.4	8.1	3.3	4.7	1"			1"			13.1	8	10.1	0.8	22.3	39
K 30/70 M	11.8	7.3	2	4.3	2.3	0.6	5.5	0.4	9.3	3.9	5.3	1"			1"			9.1	9.1	10.3	0.8	32.6	30
K 30/100 M	13.1	7.9	2	4.5	2.5	0.6	5.5	0.4	10	4.1	5.9	1 1/2"			1"			16.8	9.7	12.1	1.1	40.8	21
K 36/100 M	13.1	7.9	2	4.5	2.5	0.6	5.5	0.4	10	4.1	5.9	1 1/2"			1"			16.8	9.7	12.1	1.1	43.4	21

K

TWIN IMPELLERS CENTRIFUGAL PUMPS



K 35/40 M

Twin impeller centrifugal pump designed for use in pressurisation units for water supply systems for domestic, civil and industrial use. Suitable for sprinkling irrigation and other water supply applications. Cast iron pump body and motor support. Technopolymer impeller. Stainless steel driving shaft. Carbon/ceramic mechanical seal. Asynchronous, closed motor, cooled by external ventilation. Built-in thermal and current overload protection and a capacitor permanently on in the single-phase version. For the protection of the three-phase motor it is advisable to use a suitable overload protection complying with the regulations in force.

Operating range

from 5.3 to 132.1 GPM with head up to 318 ft

Pumped liquid characteristics

clean, free from solids or abrasive substances, non-viscous, non-aggressive, non-crystallised, chemically neutral and close to the characteristics of water

Liquid temperature range

from 14°F to +122°F

Maximum operating range

K 35/40, K 35/100, K 40/100: **87 psi**

K 45/50: **116 psi**

Maximum ambient temperature +104°F

Protection level IP 44

Terminal board protection level IP 55

Insulation class F



TECHNICAL DATA

MODEL	CODE	ELECTRICAL DATA						
		VOLTAGE 60 Hz	P1 MAX kW	P2 NOMINAL		In A	CAPACITOR	
				kW	HP		µF	Vc
K 35/40 M	TBD	1x115/230 V~	1.3	0.75	1	11.5- 5.5	80	450
K 45/50 M	102125620	1x220-230 V~	2.02	1.1	1.5	9.1- 8.7	31.5	450
K 35/100 M	102121670	1x220-230 V~	1.56	1.1	1.5	7- 6.6	31.5	450
K 40/100 M	102125740	1x220-230 V~	2	1.85	2.5	9.6- 9.2	40	450

K

TWIN IMPELLERS CENTRIFUGAL PUMPS

RANGE PERFORMANCE

K 35/40

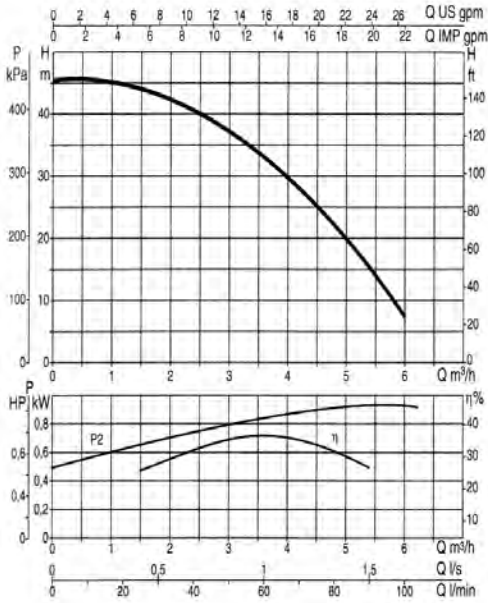

K 45/50

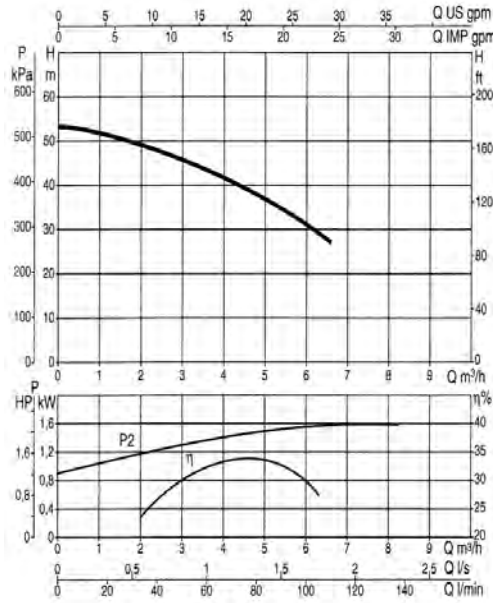

K 35/100

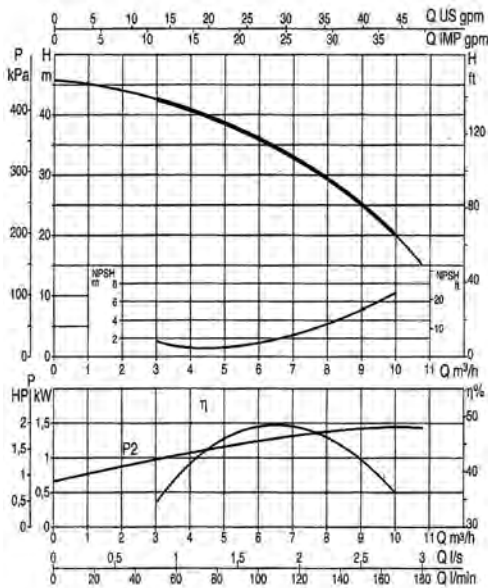

K 40/100

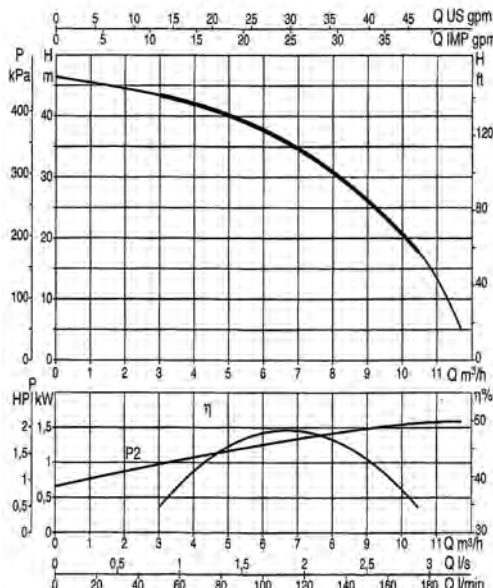

MODEL	P2 NOMINAL		Q= GPM	Flow (ft)																
	KW	HP		0	1.3	2.6	4	5.3	7.9	10.6	15.8	21.1	26.4	31.7	39.6	42.2	10.5	12		
K 35/40 M	0.75	1	H (ft)	147				138	133	125	104	73	16							
K 45/50 M	1.1	1.5		174				167	163	157	140	121	102	59						
K 35/100 M	1.1	1.5		123							118	113	105	95	81	54	44	4.0		
K 40/100 M	1.85	2.5		150							148	144	136	128	116	93	82	18.1	4.6	

K

TWIN IMPELLERS CENTRIFUGAL PUMPS

DIMENSIONS AND WEIGHTS

K 35/40

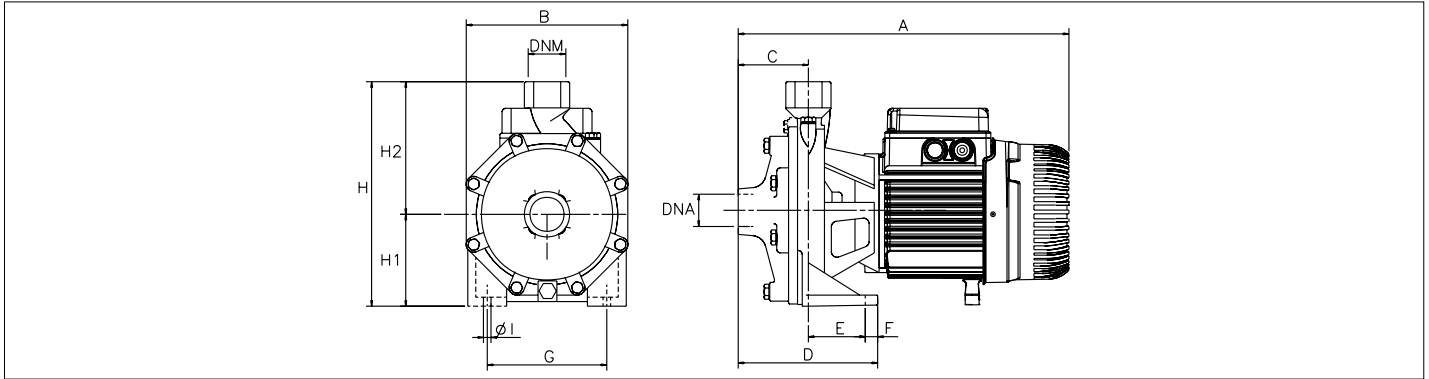

K 45/50

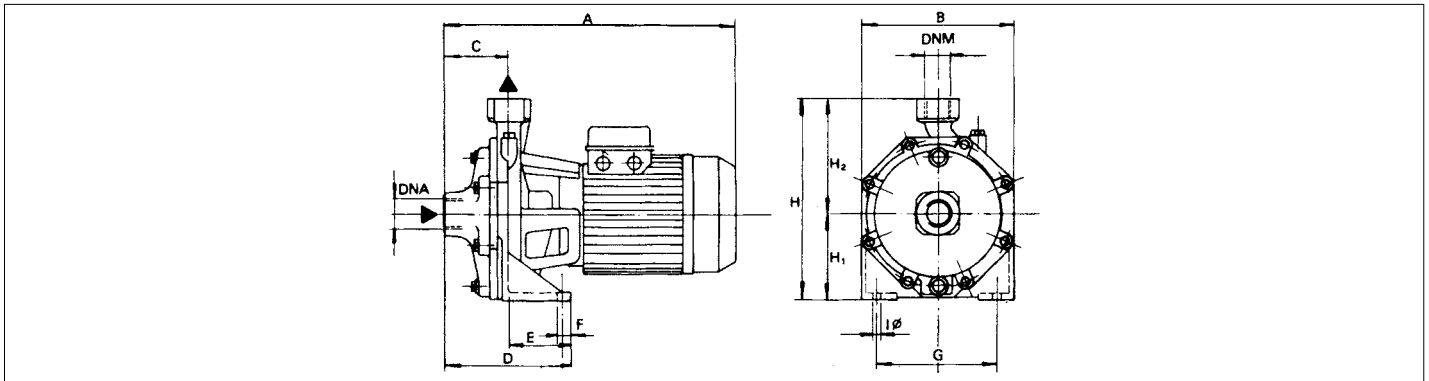

K 35/100

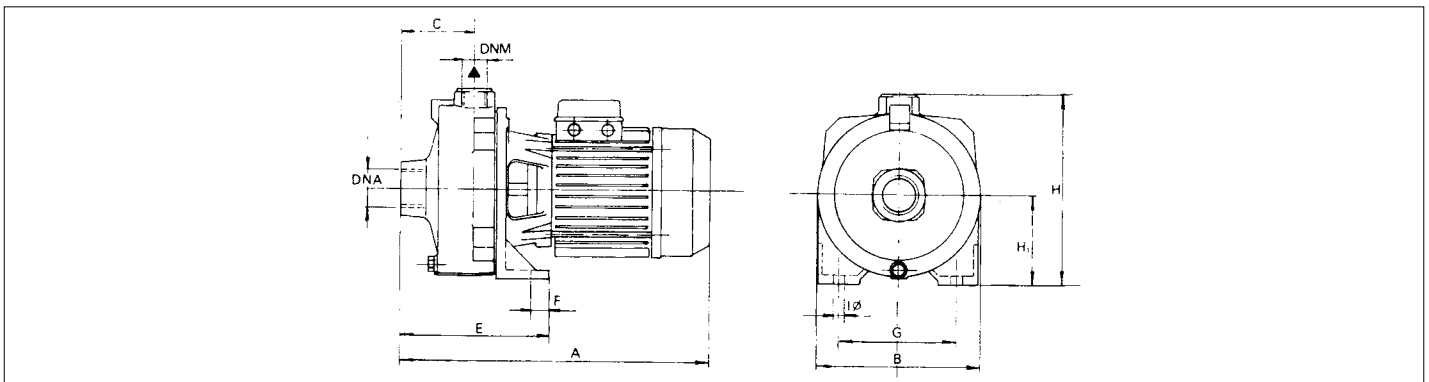

MODEL	A	B	C	D	E	F	G	I Ø	H	H1	H2	DNA NPT	DNM NPT	PACKAGING DIMENSIONS			VOLUME ft³	WEIGHT lbs	Q.TY x PALLET
														L/A	L/B	H			
K 35/40 M	14.3	8.5	3	5.8	2.8	0.6	5.8	0.4	9.3	3.9	5.3	1"	1"	15.4	9.1	14.3	0.8	35.9	27
K 45/50 M	14.6	12.2	3	5.7	2.7	0.6	6.5	0.5	10.6	4.6	5.9	1 1/4"	1"	16.8	9.7	11.7	1.1	51.4	21
K 35/100 M	15.2	8.1	3.5	-	7	0.8	5.7	0.4	9.2	4.3	4.9	1 1/2"	1"	16.8	9.7	11.7	1.1	47.4	21
K 40/100 M	18.1	8.1	3.5	-	7	0.8	5.7	0.4	9.2	4.3	4.9	1 1/2"	1"	20.6	9.7	11.7	1.1	50.7	18

DP

PUMPS FOR DEEP SUCTION



DP 82-102



DP 150-200

Self-priming centrifugal pump for suction up to 89 ft, reached by means of an ejector.

Cast iron pump body and motor support.

Technopolymer impeller and diffusers.

Stainless steel adjustment rings. Carbon / ceramic mechanical seal. Cast iron ejector body, technopolymer Venturi tube and brass nozzle. Asynchronous motor closed and cooled by external ventilation.

Built-in thermal current overload protection and a capacitor permanently on in the single-phase version. For the protection of the three-phase motor it is advisable to use a suitable overload protection complying with the regulations in force.

Operating range from 0.7 to 18.9 GPM

Liquid temperature range

from 32°F to +104°F for other uses

from 32°F to +95°F for domestic use

Pumped liquid characteristics clean, free from solids or abrasive substances, non-viscous, non-aggressive, non-crystallised and chemically neutral.

Maximum ambient temperature +104°F

Maximum working pressure

87 psi for DP 82 - DP 102

116 psi for DP 151 - DP 251

Protection level IP 44

Insulation class F



C US

ACCESSORIES
PAG. 61

TECHNICAL DATA

MODEL	CODE	ELECTRICAL DATA						
		VOLTAGE 60 Hz	P1 MÁX kW	P2 NOMINAL		In A	CAPACITOR	
				kW	HP		µF	Vc
DP 82 M	60119487	1x115/230 V~	0.9	0.6	0.8	7.09-3.61	50	450
DP 102 M	60119488	1x115/230 V~	1.12	0.75	1	9.2-4.67	50	450
DP 150	102166341	1x220-230 V~	1.7	1.1	1.5	7.6	31.5	450
DP 200	102166351	1x220-230 V~	1.9	1.82	2	8.5	40	450

DP

PUMPS FOR DEEP SUCTION

RANGE PERFORMANCE

HYDRAULIC DATA (n ≈ 2800 r.p.m.)																	
MODEL	P2 NOMINAL		EJECTOR TYPE	SUCTION DEPTH mt.	Discharge pressure in psi												
	kW	HP			22	29	36	44	51	58	65	73	80	87	94	102	
					Flow rate table in GPM												
DP 82 M	0.6	0.8	E 25	30	8	4.8	2	0.1	-	-	-	-	-	-	-	-	
				39	6.3	1	-	-	-	-	-	-	-	-	-	-	
				49	4	1.4	-	-	-	-	-	-	-	-	-	-	
			E 30	30	7.7	5.7	3.6	2.3	1.1	0.1	-	-	-	-	-	-	-
				39	5.9	4.2	2.7	1.4	0.7	0	-	-	-	-	-	-	
				49	5.1	3.4	2	1	0.2	-	-	-	-	-	-	-	
DP 102 M	0.75	1	E 25	30	10.5	7.7	4.8	2.3	0.6	-	-	-	-	-	-	-	
				39	8.5	5.2	2.4	0.4	-	-	-	-	-	-	-		
				49	6.4	3.4	1.1	-	-	-	-	-	-	-	-		
			E 30	39	-	5.5	3.8	2.5	1.4	0.7	-	-	-	-	-	-	
				49	-	4.5	3.1	2	1.1	0.4	-	-	-	-	-		
				59	-	3.5	2.3	1.3	0.7	0.1	-	-	-	-	-		
69	-	2.8	1.6	0.8	0.2	-	-	-	-	-	-	-					
DP 150	1.1	1.5	E 20	30	-	-	-	15.3	12.7	9.8	6.6	3.3	-	-	-	-	
				39	-	-	-	13.7	11.1	8.1	4.8	1.3	-	-	-		
				49	-	-	-	11.9	9.2	6.1	2.8	-	-	-	-		
				59	-	-	-	10.4	7.5	4.2	-	-	-	-	-		
			E 25	49	-	-	-	12.3	10.3	8.1	5.9	4	2.3	-	-	-	
				59	-	-	-	11.1	9	6.8	4.8	3	1.3	-	-	-	
				69	-	-	-	10	7.9	5.7	3.8	2.1	-	-	-		
			E 30	69	-	-	-	8	7.3	6.2	5.1	4	3.1	2.3	-	-	
				79	-	-	-	7.4	6.7	5.5	4.5	3.4	2.6	1.8	-	-	
89	-	-	-	6.8	6	4.9	3.9	3	2.2	1.5	-	-					
DP 200	1.85	2	E 20	30	-	-	-	18.9	15.9	12.8	9.6	6.2	2.8	-	-	-	
				39	-	-	-	16.5	13.8	11.2	7.5	4.1	-	-	-		
				49	-	-	-	-	12.2	9	5.7	2.2	-	-	-		
				59	-	-	-	-	10.3	7.1	3.6	-	-	-	-		
			E 25	49	-	-	-	-	12.9	10.6	8.4	6.2	4.2	2.5	-	-	
				59	-	-	-	-	11.4	9.3	7.1	5.1	3.2	1.6	-	-	
				69	-	-	-	-	10.3	8.1	5.9	4	2.2	-	-		
			79	-	-	-	-	9	6.8	4.8	2.9	1.3	-	-			
			E 30	69	-	-	-	-	-	7.5	6.5	5.4	4.3	3.4	2.6	1.8	
				79	-	-	-	-	-	7	5.9	4.8	3.7	2.9	2.2	1.5	
				89	-	-	-	-	-	6.3	5.3	4.2	3.3	2.5	1.8	1.1	

DP

PUMPS FOR DEEP SUCTION

DIMENSIONS AND WEIGHTS

DP 82-102

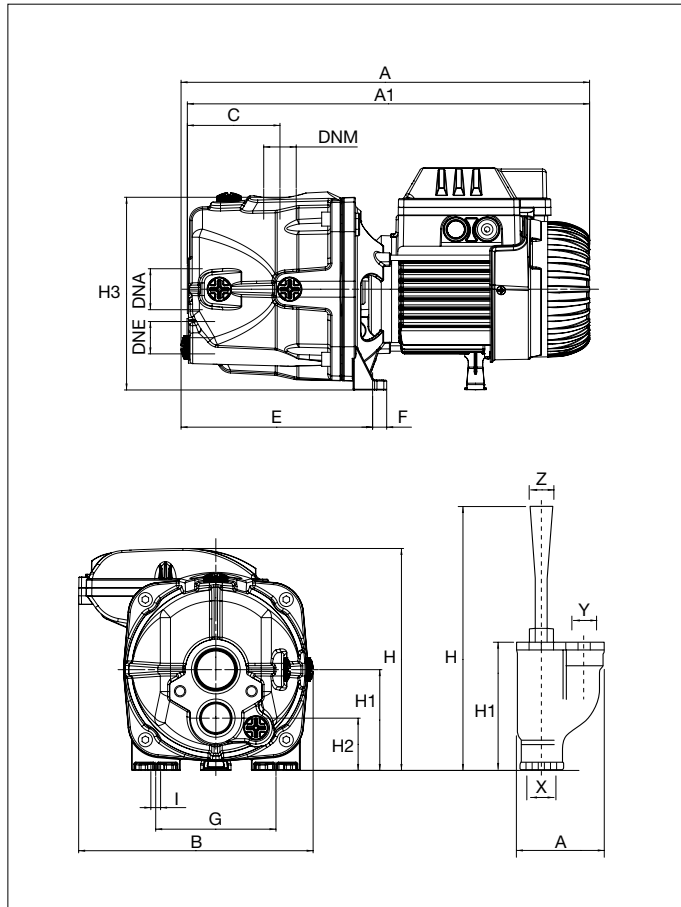

DP 150-200 Transformable

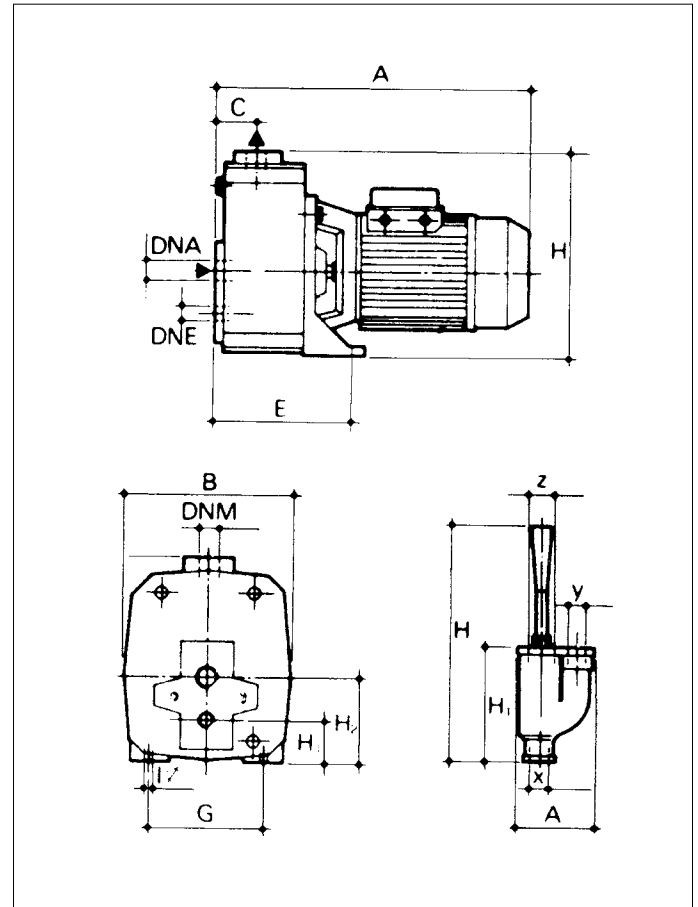

MODEL	A	A1	B	C	E	G	I Ø	H	H1	H2	H3	I	DNA (NPT)	DNM (NPT)	DNE (NPT)	EJECTOR						PACKING DIMENSIONS			Q.TY x PALLET
																A	H	H1	Ø (NPT)			L/A	L/B	H	
																			x	y	z				
DP 82 M	14.8	14.6	6.9	3.4	7	4.4	-	7.6	3.7	1.9	7	0.4	1 1/4"	1"	1"	3.8	11.6	5.6	1"	1"	1 1/4"	18.9	9.4	9.4	22
DP 102 M	15.7	15.4	6.9	3.4	7	4.4	-	8	3.7	1.9	7	0.4	1 1/4"	1"	1"	3.8	11.6	5.6	1"	1"	1 1/4"	18.9	9.4	9.4	22
DP 150	15.3	-	8.3	2	7.8	5.7	0.4	6.1	2	4.3	-	-	1 1/4"	1"	1"	3.8	11.6	5.6	1"	1"	1 1/4"	-	-	-	22
DP 200	18.2	-	8.3	2	7.8	5.7	0.4	6.1	2.1	4.3	-	-	1 1/4"	1"	1"	3.8	11.6	5.6	1"	1"	1 1/4"	-	-	-	22

DP

PUMPS FOR DEEP SUCTION

INSTRUCTION FOR CONVERSION

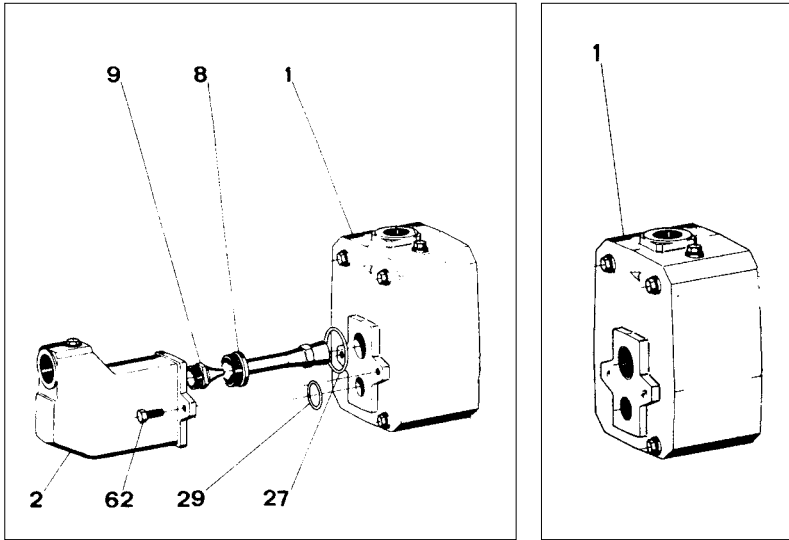

Conversion from DP 150-200 to JET 150-200

Screw the nozzle (9) into place on the ejector's body (2) and the Venturi tube (8). Put the O-rings (27) and (29) in their respective places and fix the ejector body (2) to the pump body (1) using the two screws (62).

Conversion from JET 150-200 to DP 150-200

Loosen and remove the two screws (62) connecting the ejector body (2) to the pump body (1). Save the O-rings (27) and (29), the Venturi tube (8) and the nozzle (9).

ACCESSORIES - EJECTORS

MODEL	CODE	DIMENSION inch	WEIGHT lbs	Q.TY x PALLET
EJECTOR E 20	109205000	3 X 4 X 11	8	N/A
EJECTOR E 25	109205020	3 X 4 X 11	8	N/A
EJECTOR E 30	109205010	3 X 4 X 11	8	N/A



NOTES



A large grid of graph paper for taking notes, consisting of 20 columns and 30 rows of small squares.

INDEX - SUBMERSIBLE PUMPS AND MOTORS



BHP 750 / 1000
4" SUBMERSIBLE PUMPS

PAGE 64



S4
4" SUBMERSIBLE ELECTRIC PUMPS

PAGE 66



4TW
SUBMERSIBLE MOTOR 4"

PAGE 97



4GG
SUBMERSIBLE MOTOR 4"

PAGE 99



4GX
SUBMERSIBLE MOTOR 4"

PAGE 102



6GF
SUBMERSIBLE MOTOR 6"

PAGE 105



TR8
SUBMERSIBLE MOTOR 8"

PAGE 108



TR10
SUBMERSIBLE MOTOR 10"

PAGE 111



TR12
SUBMERSIBLE MOTOR 12"

PAGE 114



TR14
SUBMERSIBLE MOTOR 14"

PAGE 117



DIVER 6
SUBMERSIBLE MULTI-IMPELLER PUMPS

PAGE 120



DTRON 2
7" ELECTRONIC MULTISTAGE SUBMERSIBLE PUMPS

PAGE 122



DTRON 3
7" ELECTRONIC MULTISTAGE SUBMERSIBLE PUMPS

PAGE 124

ACCESSORIES

PAGE 127

BHP 750 / 1000

4" SUBMERSIBLE PUMPS



4" multi-impeller submersible pumps designed for pressurization, gardening and irrigation, withdraw water from underground in domestic and residential, civil and commercial areas and irrigation systems also in agriculture.

Flow rate up to 26 GPM

Head up to 180 ft

Maximum immersion depth 49 ft

Type of pumped liquid clean, free of solids and abrasive substances, non-viscous, non-aggressive, non-crystallized and chemically neutral

Liquid temperature from +32°F to +104°F

Maximum operating pressure 116 psi

Pump maximum diameter 3.9"

Single phase power input 1x115v60Hz / 1x230v60Hz

Power cable and plug 10 ft

Possible type of installation fixed in vertical position

Certification CSA Standard C22.2 No. 108-14; UL 778



TECHNICAL DATA

MODEL	CODE	ELECTRICAL DATA			
		VOLTAGE 60 Hz	P1 MAX kW	In MAX A	CAPACITOR
BHP 750 HP 115V 60 HZ	60201432	115 V	0.9	8.5	35µF ; V250
BHP 750 HP 230V 60 HZ	60201434	230 V	0.9	4	16µF ; V450
BHP 1000 115V 60 HZ	60201433	115 V	1.2	11.5	40µF ; V250
BHP 1000 230V 60 HZ	60201435	230 V	1.2	5.5	16µF ; V450

BHP 750 / 1000

4" SUBMERSIBLE PUMPS

RANGE PERFORMANCE

MODEL	HYDRAULIC DATA									
	Q= GPM	0	4	8	12	16	20	22	24	27
BHP 750 HP 115V 60 HZ	ft	177	156	132	99	50	3			
BHP 750 HP 230V 60 HZ		177	156	132	99	50	3			
BHP 1000 115V 60 HZ		180	165	150	135	105	70	48	30	3
BHP 1000 230V 60 HZ		180	165	150	135	105	70	48	30	3

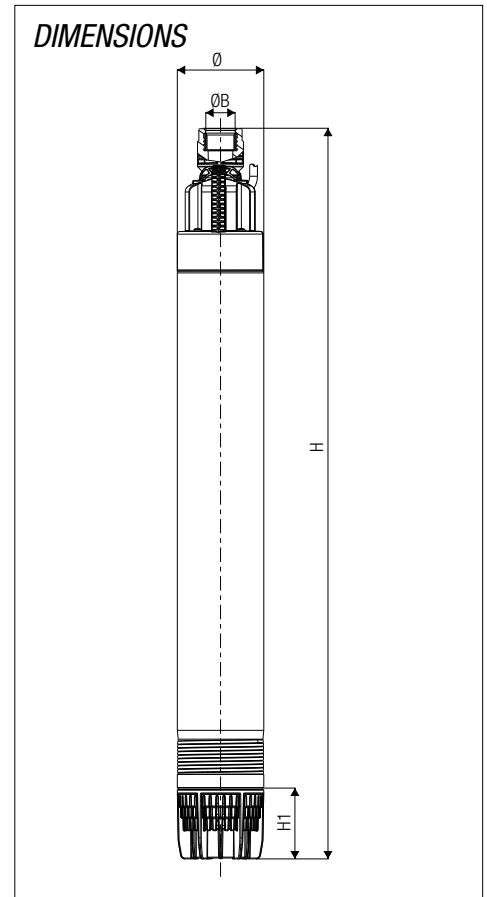
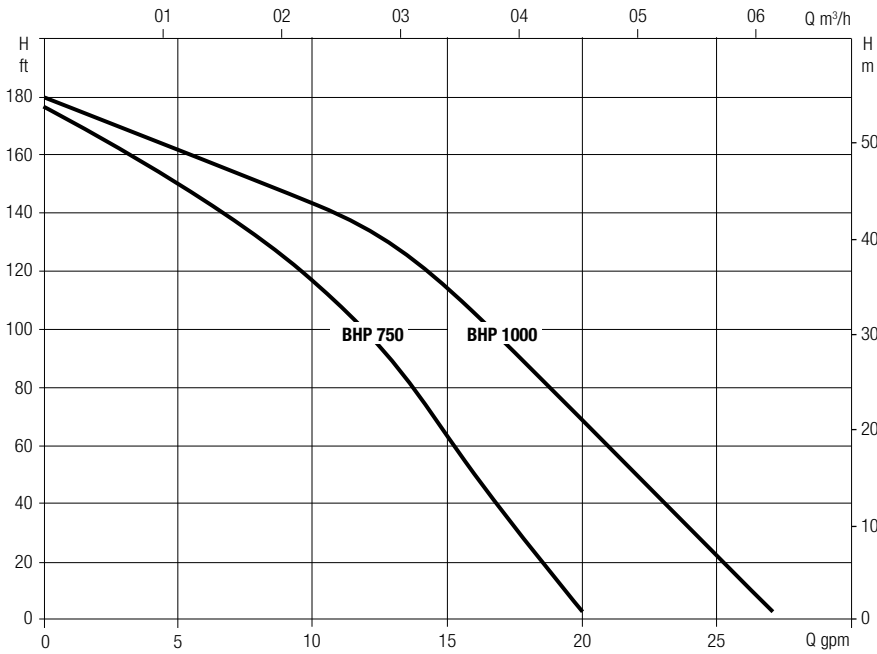

DIMENSIONS AND WEIGHTS

MODEL	Ø inch	ØB inch	H inch	H1 inch	PACK DIMENSIONS			WEIGHT Lbs
					L/A	L/B	H	
BHP 750 HP 115V 60 HZ	3.9	1"NPT F	32.6	3.1	36	6.3	6.3	28.7
BHP 750 HP 230V 60 HZ	3.9	1"NPT F	32.6	3.1	36	6.3	6.3	28.7
BHP 1000 115V 60 HZ	3.9	1"NPT F	32.6	3.1	36	6.3	6.3	28.7
BHP 1000 230V 60 HZ	3.9	1"NPT F	32.6	3.1	36	6.3	6.3	28.7

S4

4" SUBMERSIBLE ELECTRIC PUMPS



4" multi-impeller borehole pumps for clean water, designed for water boosting, gardening and irrigation, lifting water from boreholes in residential building service, commercial building service and irrigation systems also for agriculture. The S4 pumps must be installed in wells with a diameter of at least 4", or in tanks or cisterns and it increases the pressure of water that can be used for example to water medium or large gardens or (in the case of models with a greater flow and head) in irrigation systems in agriculture.

Available as standard:

- Only pump end
- Pump body with water-filled motor 2WIRE
- Pump body with water-filled motor 3WIRE

Flow rate up to 120 GPM

Head up to 1500 ft

Maximum immersion depth 4GG - 4TW: 984 ft

Type of pumped liquid clean, free of solids and abrasive substances, non-viscous, non-aggressive, non-crystallized and chemically neutral

Sand quantity 5.42 lb/in³

Liquid temperature from +32°F to +104°F

Output connection

S4 5-25: 1" 1/4 NPT

S4 35-90: 2" NPT

Pump maximum diameter 3.9 in

Impeller/s material technopolymer

Maximum number of starts IP 68

Protection class 20/h

Motor insulation class F

Single phase power input

1x115 V 60Hz / 1x230 V 60 Hz

Three phase power input

3x230 V 60 Hz / 3x460 V 60 Hz

Possible type of installation fixed in vertical position. Horizontal installation is possible, it is recommended to install a cooling sleeve

Special versions on request different voltages, different cable lengths, version with 4GX

Certification pump end NSF61 certificate is pending approval.

4GG - 4TW motor: CSA approved



TECHNICAL DATA -S4 5

MODEL	2 WIRE	3 WIRE	PUMP END
	CODE	CODE	CODE
S4 5/05			60198611
	60198632	60198655	
	60198636	60198659	
S4 5/07			60198612
	60198637	60198660	
S4 5/10			60198613
	60198638	60198661	
S4 5/15			60198614
	60198639	60198662	
S4 5/20	-	-	60196210

VOLTAGE	ASSEMBLED VERSION	MOTOR TYPE	P2 HP	STAGES
-	-	NO MOTOR	0.5	11
115	YES*	4TW 2W 4GG 3W		
230	YES*	4TW 2W 4GG 3W	0.75	15
-	-	NO MOTOR		
230	YES*	4TW 2W 4GG 3W	1	18
-	-	NO MOTOR		
230	YES*	4TW 2W 4GG 3W	1.5	25
-	-	NO MOTOR		
230	YES*	4TW 2W 4GG 3W	2	31
-	-	NO MOTOR		

* assembled version available with canned motor 4GG and 4TW



S4 5

4" SUBMERSIBLE ELECTRIC PUMPS

RANGE PERFORMANCE

MODEL	HP	PSI	Depth to pumping water in feet																		Shut-Off (ft)					
			20	40	60	80	100	120	140	160	180	200	240	260	300	360	400	480	500	600		700	800	900	1000	
S4 5/05	1/2	0							8	7	7	6.5	5.5	5	3.5											
		20					8	7.5	7	6.5	6	5	4	3.5	1											
		30				8	7.5	7	6	6	5	4.5	3	2												
		40			8	7.5	7	6.5	6	5	4.5	4														
		50		7.5	7	6.5	6	5.5	5	4	3.5	2.5														
		60	7	7	6.5	6	5.5	4.5	4	3.5																
		80	6.5	6	5.5	5	4	3.5																		
Shut-off PSI		146	137	129	120	111	103	94	85	77	68	51	42	25										153		
S4 5/07	3/4	0								8	7.5	7	6.5	5.5	4.5	3.5										
		20							7.5	7.5	7	6.5	6	5.5	4.5	3.5	2									
		30							7.5	7	7	6.5	6	5.5	5	3.5	2.5									
		40					7	7	7	6.5	6	5.5	5	4	3.5	2										
		50				7	7	6.5	6.5	6	5	5	4	3.5	3											
		60			7	7	6.5	6.5	6	5	5	4.5	3.5	3												
		80	7	7	6.5	6	6	5.5	5	4.5	4	3.5	3													
Shut-off PSI		195	186	177	169	160	151	143	134	125	117	99	91	73	47	30							203			
S4 5/10	1	0												7.5	7	6	5.5	4	3.5							
		20												7	7	6.5	5.5	4.5	3	2						
		30												7	6.5	6.5	6	5	4	2.5						
		40												7	7	6.5	6.5	5.5	4.5	3.5						
		50												7	7	6.5	6	5.5	5	4	3					
		60												7	7	6.5	6	5.5	5.5	5	3.5	2.5				
		80												7	6.5	6.5	6	5.5	5	4.5	4	2.5				
Shut-off PSI		245	236	227	219	210	202	193	184	176	167	150	141	124	98	80	46	37					253			
S4 5/15	1.5	0														6.5	6	5.5	4.5	3	1					
		20														7	6.5	6	5.5	5	4	2				
		30														7	7	6.5	6	5	4.5	3.5	1.5			
		40														7	7	6.5	6	5.5	4.5	4.5	3			
		50														7	7	6.5	6.5	6	5.5	4.5	4	2.5		
		60														7	7	6.5	6.5	6	5.5	5	4	3.5	2.5	
		80														7	7	6.5	6.5	6	5.5	5	4.5	3.5	3	
Shut-off PSI		342	333	325	316	307	299	290	281	273	264	247	238	221	195	177	143	134	91	47	4		350			
S4 5/20	2	0																7	7	6	5	4	2.5			
		20																7	7	6.5	5	4.5	3.5	2		
		30																7	7	6.5	6	5	4.5	3		
		40																7	7	7	6	6	5	4	2.5	
		50																7	7	7	6.5	6	6	5	4	2
		60																7	7	7	6.5	6.5	6	5.5	4.5	3.5
		80																7	7	7	7	6.5	6	5.5	5	4
Shut-off PSI		419	410	401	393	384	375	367	358	349	341	323	315	297	271	254	219	211	168	124	81	38		427		

NOTE: performances shown does not include friction loss in the drop pipe. All performance data is based on rated motor nameplate voltage.



S45

4" SUBMERSIBLE ELECTRIC PUMPS

RANGE PERFORMANCE

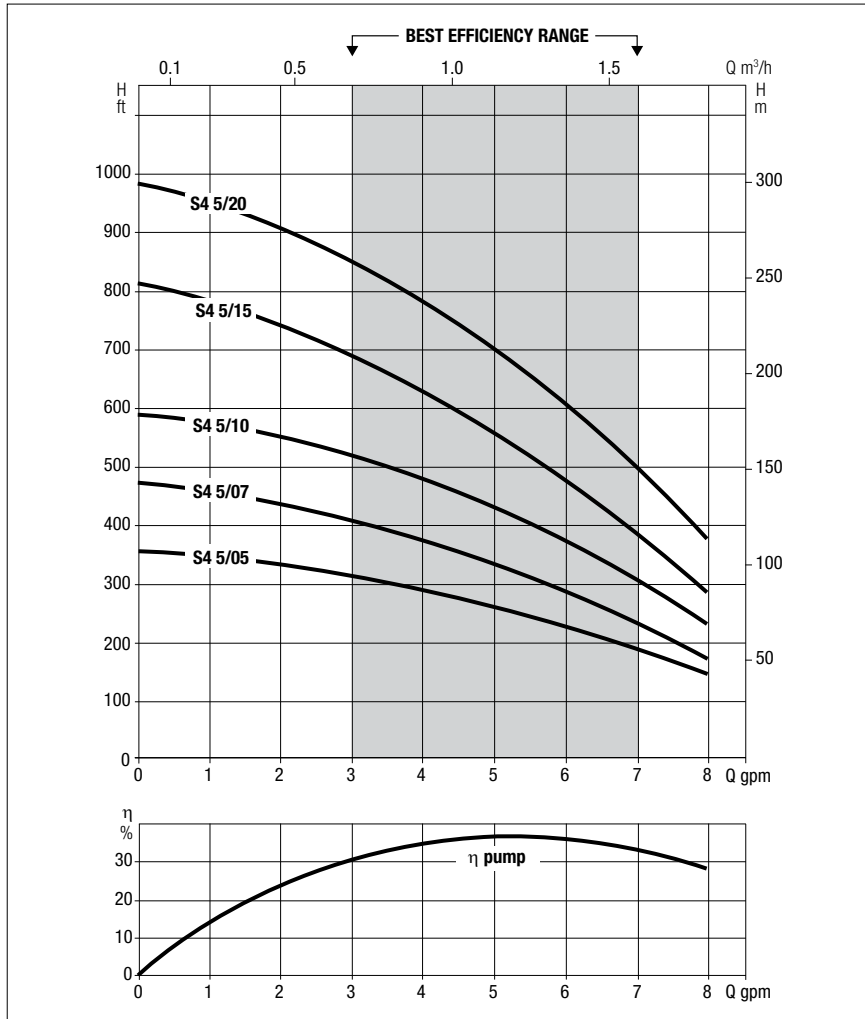

Curve tolerance according to ISO 9906

DIMENSIONS

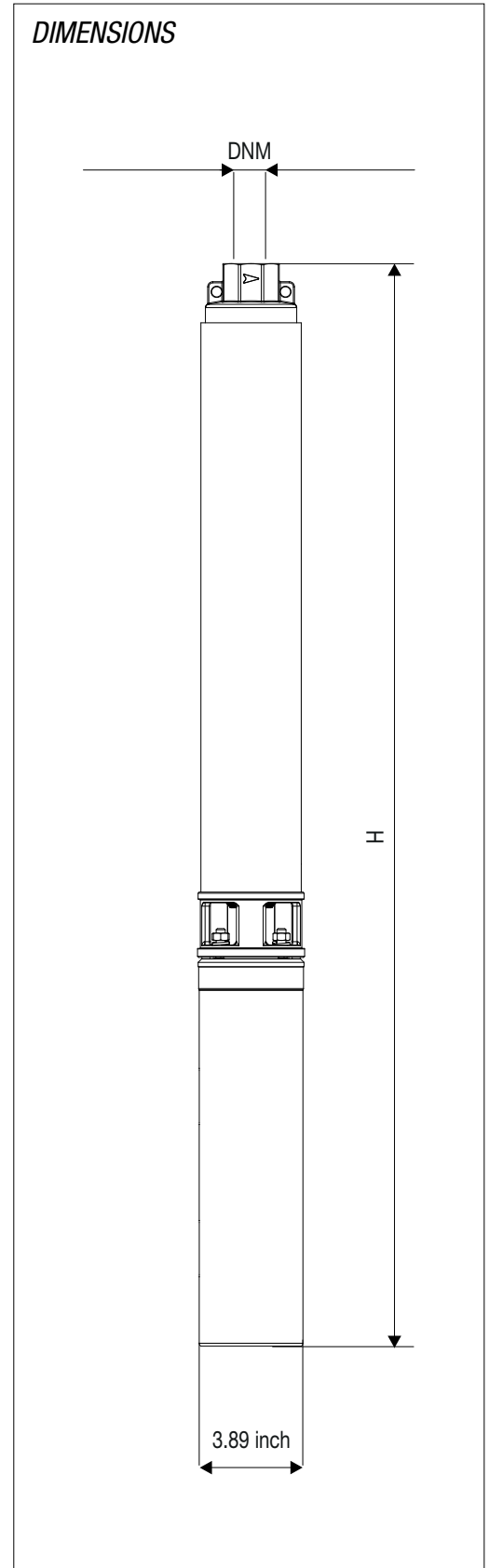

DIMENSIONS AND WEIGHTS

MODEL	H LENGTH inch	GROSS WEIGHT lbs	DISCHARGE SIZE npt
S4 5/05	15.8	7.3	1" 1/4
	29.3	28.5	
	26.3	26.7	
	28.9	28.3	
	26.3	26.7	
S4 5/07	18.5	8.6	1" 1/4
	32.3	31.9	
	29.8	30.0	
S4 5/10	20.7	9.7	1" 1/4
	37.5	38.4	
S4 5/15	34.3	37.6	1" 1/4
	25.5	11.7	
	44.1	44.3	
S4 5/20	40.9	44.1	1" 1/4
	25.9	16.3	

S4 7

4" SUBMERSIBLE ELECTRIC PUMPS

TECHNICAL DATA

MODEL	2 WIRE	3 WIRE	PUMP END	VOLTAGE	ASSEMBLED VERSION	MOTOR TYPE	P2 HP	STAGES
	CODE	CODE	CODE					
S4 7/05			60198615	-	-	NO MOTOR	0.5	8
	60198633	60198656		115	YES*	4TW 2W		
						4GG 3W		
S4 7/07	60198640	60198663		230	YES*	4TW 2W	0.75	11
						4GG 3W		
S4 7/10			60198616	-	-	NO MOTOR	1	14
	60198641	60198664		230	YES*	4TW 2W		
S4 7/15			60198617	-	-	NO MOTOR	1.5	19
	60198642	60198665		230	YES*	4TW 2W		
S4 7/20			60198618	-	-	NO MOTOR	2	24
	60198643	60198666		230	YES*	4TW 2W		
S4 7/30			60196215	-	-	NO MOTOR	3	33
S4 7/30			60196216	-	-	NO MOTOR	3	33

* assembled version available with canned motor 4GG and 4TW

S4 7

4" SUBMERSIBLE ELECTRIC PUMPS

RANGE PERFORMANCE

MODEL	HP	PSI	Depth to pumping water in feet																		Shut-Off (ft)										
			20	40	60	80	100	120	140	160	180	200	240	260	300	360	400	480	500	600		700	800	900	1000						
S4 7/05	1/2	0					11	10	10	9	8	7	5	3																	
		20				10	9	9	8	7	5	3																			
		30			10	9	8	7	7	6	3																				
		40		10	9	8	7	7	5	3																					
		50	10	9	8	7	5	3																							
		60	9	8	7	6	4																								
		80	7	6	5																										
	Shut-off PSI	114	105	97	88	79	71	62	53	45	36	19	10											123							
S4 7/07	3/4	0						11	10	10	10	8	7	6	3																
		20					10	10	10	9	8	7	6	3																	
		30					10	10	9	9	8	7	6	4	2																
		40				10	10	9	9	8	7	7	3.5																		
		50			10	10	9	8	7	7	6	5	3																		
		60		10	10	9	8	7	7	6	5	4																			
		80	10	9	8	8	7	6	5	4	3																				
	Shut-off PSI	160	151	143	134	125	117	108	99	91	82	65	56	39	13																
S4 7/10	1	0								11	10	10	9	9	7	6	2														
		20								10	10	10	9	9	7	6	3														
		30								10	10	9	9	8	8	6	5	2													
		40							10	10	10	9	9	7	7	6	3														
		50					10	10	9	9	9	8	7	6	5																
		60			10	10	9	9	9	8	7	6	6	4																	
		80			10	10	9	9	8	7	7	6	5	3																	
	Shut-off PSI	209	200	191	183	174	165	157	148	139	131	113	105	87	62	44	10														
S4 7/15	1.5	0										11	10	10	9	9	7	7	4												
		20										11	10	10	9	9	8	6	5												
		30									10	10	10	9	9	8	7	5	4												
		40								10	10	10	10	9	9	8	7	4	3												
		50							10	10	10	10	9	9	8	7	6	4	3												
		60						10	10	10	10	9	9	8	8	7	6	3													
		80					10	10	10	10	9	9	8	8	7	5	4														
	Shut-off PSI	283	274	265	257	248	239	231	222	213	205	187	179	161	135	118	83	75	31				291								
S4 7/20	2	0													11	10	9	9	7	5	2										
		20														11	10	9	8	8	6	4									
		30														11	10	9	9	8	7	7	4								
		40														11	10	10	9	9	7	7	5	3							
		50														11	10	10	9	9	8	7	7	5	2						
		60														11	10	10	10	9	9	8	7	6	4						
		80														11	10	10	9	9	8	7	6	5	3						
	Shut-off PSI	364	356	347	338	330	321	312	304	295	286	269	261	243	217	200	165	157	113	70	27										
S4 7/30	3	0														10	10	10	9	8	7	6	4								
		20															10	10	10	10	9	8	7	5	3						
		30																10	10	10	10	9	9	8	6	5	3				
		40																	10	10	10	10	9	9	8	7	6	5	3		
		50																		10	10	10	10	9	9	8	7	6	4		
		60																			10	10	10	10	10	9	9	8	7	5	3
		80																				10	10	10	10	9	9	8	7	6	5
	Shut-off PSI	504	496	487	478	470	461	452	444	435	426	409	400	383	357	340	305	297	253	210	167	123	80	513							

NOTE: performances shown does not include friction loss in the drop pipe. All performance data is based on rated motor nameplate voltage.



S4 7

4" SUBMERSIBLE ELECTRIC PUMPS

RANGE PERFORMANCE

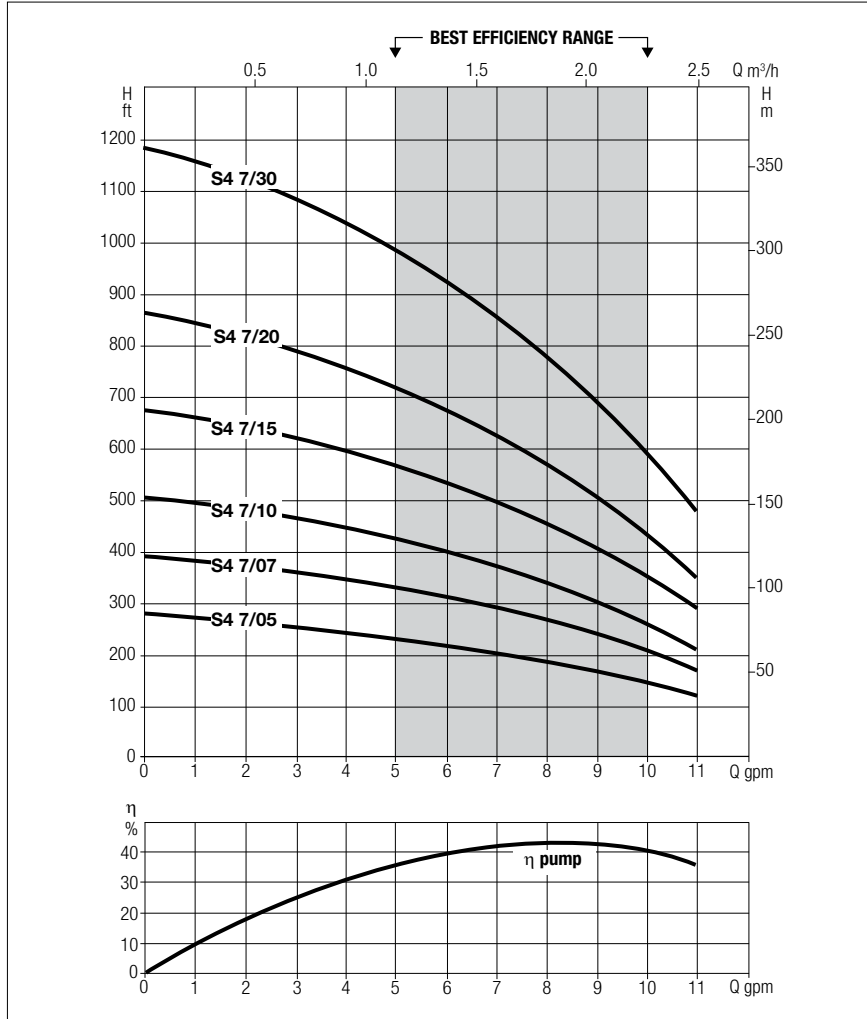

Curve tolerance according to ISO 9906

DIMENSIONS

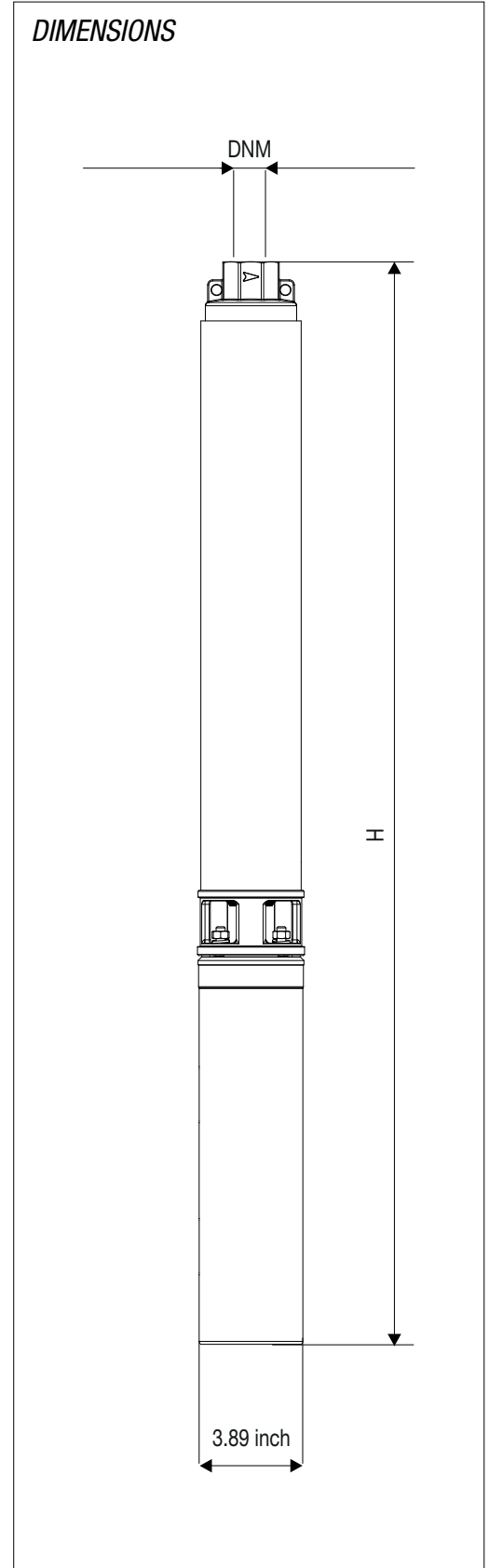

DIMENSIONS AND WEIGHTS

MODEL	H LENGTH inch	GROSS WEIGHT lbs	DISCHARGE SIZE npt
S4 7/05	15.6	6.0	1" 1/4
	29.0	27.2	
	26.1	25.4	
	28.6	27.0	
	26.1	25.4	
S4 7/07	18.4	7.3	1" 1/4
	32.2	30.5	
	29.7	28.7	
S4 7/10	21.2	8.2	1" 1/4
	37.9	36.8	
	34.8	36.0	
S4 7/15	25.8	9.9	1" 1/4
	44.4	42.5	
	41.2	42.3	
S4 7/20	30.4	11.2	1" 1/4
S4 7/30	33.8	17.2	1" 1/4

S4 10

4" SUBMERSIBLE ELECTRIC PUMPS

TECHNICAL DATA

MODEL	2 WIRE	3 WIRE	PUMP END	VOLTAGE	ASSEMBLED VERSION	MOTOR TYPE	P2 HP	STAGES
	CODE	CODE	CODE					
S4 10/05			60198619	-	-	NO MOTOR	0.5	7
	60198634	60198657		115	YES*	4TW 2W		
						4GG 3W		
S4 10/05	60198644	60198667		230	YES*	4TW 2W	0.5	7
						4GG 3W		
S4 10/07			60198620	-	-	NO MOTOR	0.75	10
	60198645	60198668		230	YES*	4TW 2W		
						4GG 3W		
S4 10/10			60198621	-	-	NO MOTOR	1	12
	60198646	60198669		230	YES*	4TW 2W		
						4GG 3W		
S4 10/15			60198622	-	-	NO MOTOR	1.5	17
	60198647	60198670		230	YES*	4TW 2W		
						4GG 3W		
S4 10/20			60196222	-	-	NO MOTOR	2	22
S4 10/30			60196223	-	-	NO MOTOR	3	29
S4 10/50			60196224	-	-	NO MOTOR	5	46

* assembled version available with canned motor 4GG and 4TW

S4 10

4" SUBMERSIBLE ELECTRIC PUMPS

RANGE PERFORMANCE

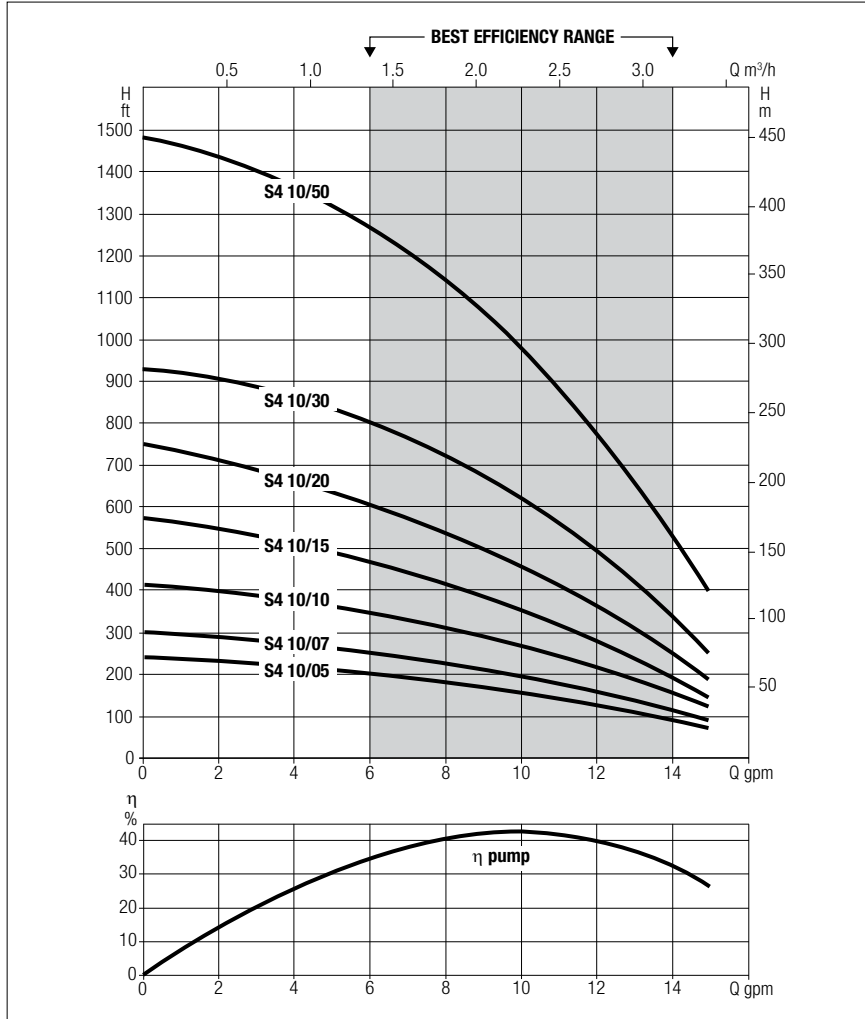

Curve tolerance according to ISO 9906

DIMENSIONS

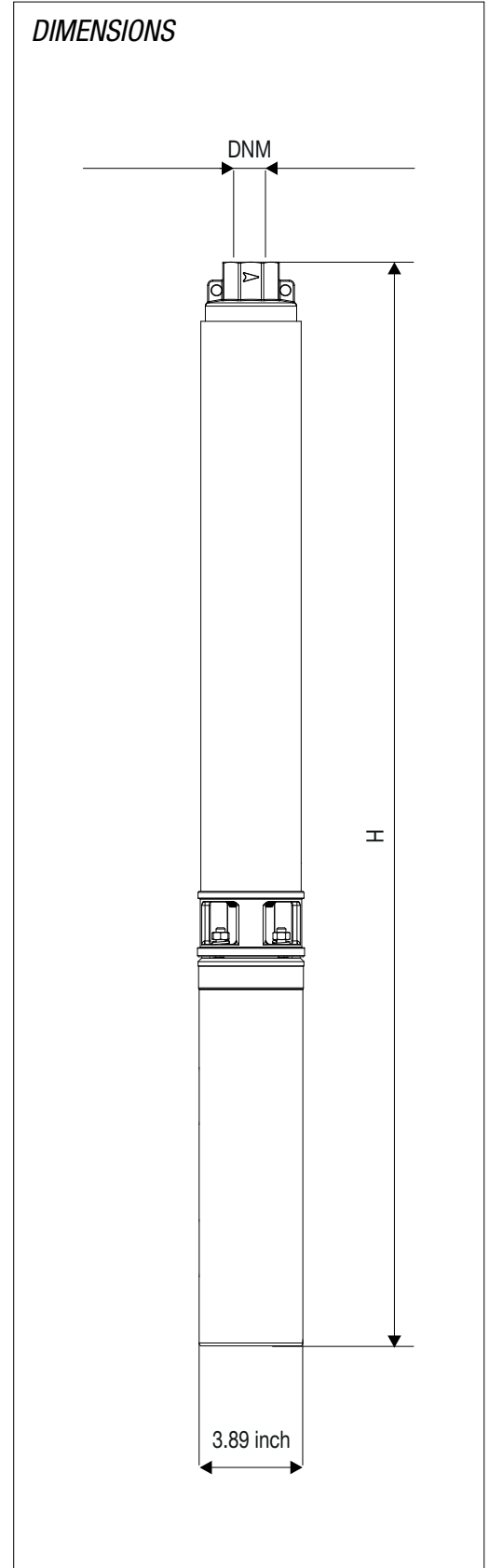

DIMENSIONS AND WEIGHTS

MODEL	H LENGTH inch	GROSS WEIGHT lbs	DISCHARGE SIZE npt
S4 10/05	14.7	6.2	1" 1/4
	28.1	27.4	
	25.2	25.6	
	27.7	27.2	
S4 10/07	25.2	25.6	1" 1/4
	17.5	7.1	
	31.3	30.3	
S4 10/10	28.7	28.4	1" 1/4
	19.3	7.7	
	36.1	36.4	
S4 10/15	32.9	35.6	1" 1/4
	24.0	9.3	
	42.5	41.9	
S4 10/20	39.4	41.7	1" 1/4
	28.6	11.0	
S4 10/30	28.6	11.0	1" 1/4
S4 10/50	35.1	13.2	1" 1/4
S4 10/50	45.7	22.9	1" 1/4

S4 15

4" SUBMERSIBLE ELECTRIC PUMPS

TECHNICAL DATA

MODEL	2 WIRE	3 WIRE	PUMP END	VOLTAGE	ASSEMBLED VERSION	MOTOR TYPE	P2 HP	STAGES
	CODE	CODE	CODE					
S4 15/05			60198623	-	-	NO MOTOR	0.5	5
	60198635	60198658		115	YES*	4TW 2W		
						4GG 3W		
S4 15/05	60198648	60198671		230	YES*	4TW 2W	0.5	5
						4GG 3W		
S4 15/07			60198624	-	-	NO MOTOR	0.75	7
	60198649	60198672		230	YES*	4TW 2W		
						4GG 3W		
S4 15/10			60198625	-	-	NO MOTOR	1	9
	60198650	60198673		230	YES*	4TW 2W		
						4GG 3W		
S4 15/15			60198626	-	-	NO MOTOR	1.5	12
	60198651	60198674		230	YES*	4TW 2W		
						4GG 3W		
S4 15/20			60196229	-	-	NO MOTOR	2	16
S4 15/30			60196230	-	-	NO MOTOR	3	23
S4 15/50			60196231	-	-	NO MOTOR	5	36

* assembled version available with canned motor 4GG and 4TW

S4 15

4" SUBMERSIBLE ELECTRIC PUMPS

RANGE PERFORMANCE

MODEL	HP	Depth to pumping water in feet																								Shut-Off (ft)
		20	40	60	80	100	120	140	160	180	200	240	260	300	360	400	480	500	600	700	800	900	1000	1100	1200	
S4 15/05	1/2	0			21	19	16	13	9																	163
		46		18	15	11	7																			
		69	17	14	10	5																				
		92	14	10	5																					
		116	9	4																						
		139																								
		185																								
Shut-off PSI	62	53	45	36	27	19	10																	71		
S4 15/07	3/4	0				21	20	18	16	13	11	8													229	
		46				19	17	15	13	10	6															
		69		19	17	15	12	10	5																	
		92	19	17	15	12	10	5																		
		116	17	14	12	9	4																			
		139	13	11	8	3																				
		185	8	3																						
Shut-off PSI	90	82	73	64	56	47	38	30	21	12													99			
S4 15/10	1	0						20	19	18	16	14	10	8											301	
		46						19	18	16	14	13	10	5												
		69					18	17	15	13	11	9	7													
		92				18	17	15	14	11	9	6	3													
		116		18	17	15	12	10	8	5																
		139	18	16	14	12	10	7	4																	
		185	14	13	11	7	4																			
Shut-off PSI	122	113	104	96	87	78	70	61	52	44	26	18											130			
S4 15/15	1.5	0							21	20	19	19	16	14	12	6									401	
		46					21	20	19	18	17	16	13	12	7											
		69				21	20	19	18	16	15	14	11	9	5											
		92			21	20	19	18	16	15	14	13	9	8												
		116		21	19	19	17	16	14	13	12	10	6	3												
		139	20	19	18	17	16	14	13	12	11	8														
		185	18	17	16	15	13	12	10	9	6															
Shut-off PSI	165	156	148	139	131	122	113	105	96	87	70	61	44	18									174			
S4 15/20	2	0									21	19	18	16	13	11	5	3							531	
		46									20	19	17	16	14	11	8									
		69								20	19	19	18	16	15	12	9	5								
		92						20	19	19	17	17	15	14	11	8	4									
		116					20	19	18	17	16	15	13	12	10	5										
		139				20	19	18	17	16	15	14	12	11	8	3										
		185			19	18	17	16	15	14	13	12	9	8	4											
Shut-off PSI	221	212	204	195	187	178	169	161	152	143	126	117	100	74	57	22	13						230			
S4 15/30	3	0										21	21	20	18	17	14	14	10	4					763	
		46										21	20	20	19	17	16	13	12	8						
		69										21	21	20	19	18	16	15	12	11	6					
		92										21	21	20	19	19	18	16	14	11	10					
		116										21	20	20	19	18	18	16	14	13	10	9				
		139						21	20	20	19	19	18	17	16	14	12	9	8							
		185					20	20	19	19	18	18	16	16	14	12	10	6								
Shut-off PSI	322	313	304	296	287	278	270	261	252	244	226	218	200	174	157	123	114	71	27				330			
S4 15/50	5	0													21	20	20	18	16	13	11	8	4		1194	
		46													21	20	19	18	17	15	12	9	6			
		69													21	21	20	19	18	16	14	11	9	5		
		92													21	21	20	20	18	18	16	14	11	8		5
		116												21	21	21	20	19	18	17	15	13	10	7		
		139											21	21	21	20	20	18	17	17	15	12	10	6		
		185										21	21	20	20	20	19	18	17	16	14	11	8	5		
Shut-off PSI	508	500	491	482	474	465	456	448	439	430	413	405	387	361	344	309	301	257	214	171	127	84	41	517		

NOTE: performances shown does not include friction loss in the drop pipe. All performance data is based on rated motor nameplate voltage.



S4 15

4" SUBMERSIBLE ELECTRIC PUMPS

RANGE PERFORMANCE

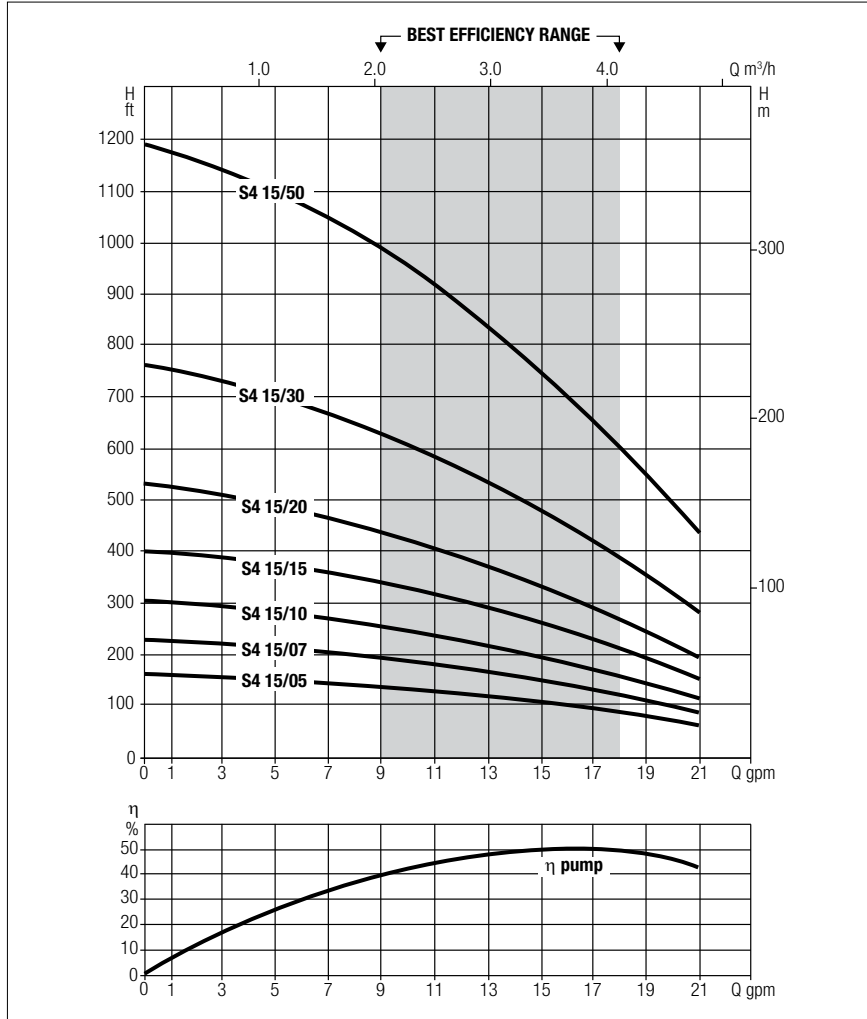

Curve tolerance according to ISO 9906

DIMENSIONS

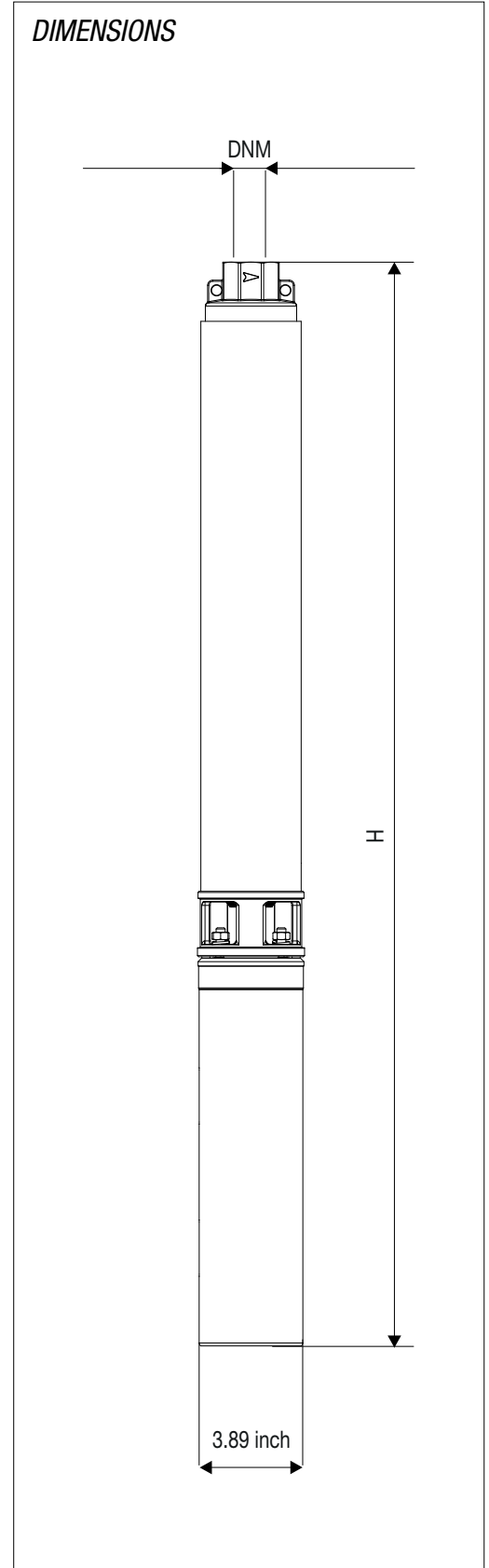

DIMENSIONS AND WEIGHTS

MODEL	H LENGTH inch	GROSS WEIGHT lbs	DISCHARGE SIZE npt
S4 15/05	13.7	6.0	1" 1/4
	27.1	27.2	
	24.2	25.4	
	26.7	27.0	
S4 15/07	24.2	25.4	1" 1/4
	15.9	6.6	
	29.7	29.9	
S4 15/10	27.1	28.0	1" 1/4
	18.1	7.5	
	34.8	36.2	
S4 15/15	31.7	35.4	1" 1/4
	21.4	8.6	
	39.9	41.2	
S4 15/20	36.8	41.0	1" 1/4
	25.7	10.4	
S4 15/30	33.4	14.1	1" 1/4
S4 15/50	42.8	20.5	1" 1/4

S4 20

4" SUBMERSIBLE ELECTRIC PUMPS

TECHNICAL DATA

MODEL	2 WIRE	3 WIRE	PUMP END	VOLTAGE	ASSEMBLED VERSION	MOTOR TYPE	P2 HP	STAGES
	CODE	CODE	CODE					
S4 20/07			60198627	-	-	NO MOTOR	0.75	6
	60198652	60198675		230	YES*	4TW 2W 4GG 3W		
S4 20/10			60198628	-	-	NO MOTOR	1	7
	60198653	60198676		230	YES*	4TW 2W 4GG 3W		
S4 20/15			60198629	-	-	NO MOTOR	1.5	10
	60198654	60198677		230	YES*	4TW 2W 4GG 3W		
S4 20/20			60196235	-	-	NO MOTOR	2	13
S4 20/30			60196236	-	-	NO MOTOR	3	18
S4 20/50			60196237	-	-	NO MOTOR	5	28

* assembled version available with canned motor 4GG and 4TW

S4 20

4" SUBMERSIBLE ELECTRIC PUMPS

RANGE PERFORMANCE

MODEL	HP	PSI	Depth to pumping water in feet																			Shut-Off (ft)								
			20	40	60	80	100	120	140	160	180	200	240	260	300	360	400	480	500	600	700		800	900	1000	1100	1200			
S4 20/07	3/4	0	0				28	26	23	18	13	8																		
		20	46			24	22	18	13	8																				
		30	69		24	21	16	11																						
		40	92	24	21	17	11																							
		50	116	21	17	8																								
		60	139	13	8																									
		80	185																											
	Shut-off PSI		76	68	59	50	42	33	24	16	7																	85		
S4 20/10	1	0	0						26	25	22	19	17	9																
		20	46					24	22	19	16	12	8																	
		30	69				24	21	19	15	12	5																		
		40	92			24	21	19	14	12	5																			
		50	116			23	20	18	15	8																				
		60	139	22	20	17	12	9																						
		80	185	16	12	7																								
	Shut-off PSI		105	96	88	79	70	62	53	44	36	27	10														114			
S4 20/15	1.5	0	0							26	25	23	22	16	14	8														
		20	46							24	23	21	18	16	10	6														
		30	69						24	20	20	18	15	12																
		40	92				24	22	20	18	15	12	10																	
		50	116			23	21	20	16	14	10	8																		
		60	139		23	21	18	16	14	10	8																			
		80	185	21	18	16	12	10																						
	Shut-off PSI		130	122	113	104	96	87	78	70	61	52	35	27	9												139			
S4 20/20	2	0	0								26	23	22	18	12	6														
		20	46									24	22	20	18	13	5													
		30	69								24	23	22	20	17	15	10													
		40	92						24	23	22	20	18	15	15	6														
		50	116					24	23	22	20	18	15	12	8															
		60	139				24	23	21	20	18	16	14	8																
		80	185			23	21	20	18	16	14	12	8																	
	Shut-off PSI		174	166	157	148	140	131	122	114	105	96	79	70	53	27	10										183			
S4 20/30	3	0	0												25	22	20	12	11											
		20	46													25	23	20	16	9	6									
		30	69														24	23	21	17	12	6								
		40	92											24	23	22	20	16	12											
		50	116												24	23	22	21	18	12	6									
		60	139													24	23	22	21	20	17	11								
		80	185														24	23	22	20	18	16	12							
	Shut-off PSI		242	234	225	216	208	199	190	182	173	164	147	138	121	95	78	43	34								251			
S4 20/50	5	0	0															25	23	19	13									
		20	46																25	24	21	16	10							
		30	69																	25	24	23	19	14	6					
		40	92																		25	24	23	22	18	12	6			
		50	116																			25	24	24	22	21	18	11		
		60	139																				25	24	24	23	22	21	16	10
		80	185																					25	25	24	23	23	20	19
	Shut-off PSI		407	398	389	381	372	363	355	346	337	329	311	303	285	259	242	208	199	156	112	69						415		

NOTE: performances shown does not include friction loss in the drop pipe. All performance data is based on rated motor nameplate voltage.



S4 20

4" SUBMERSIBLE ELECTRIC PUMPS

RANGE PERFORMANCE

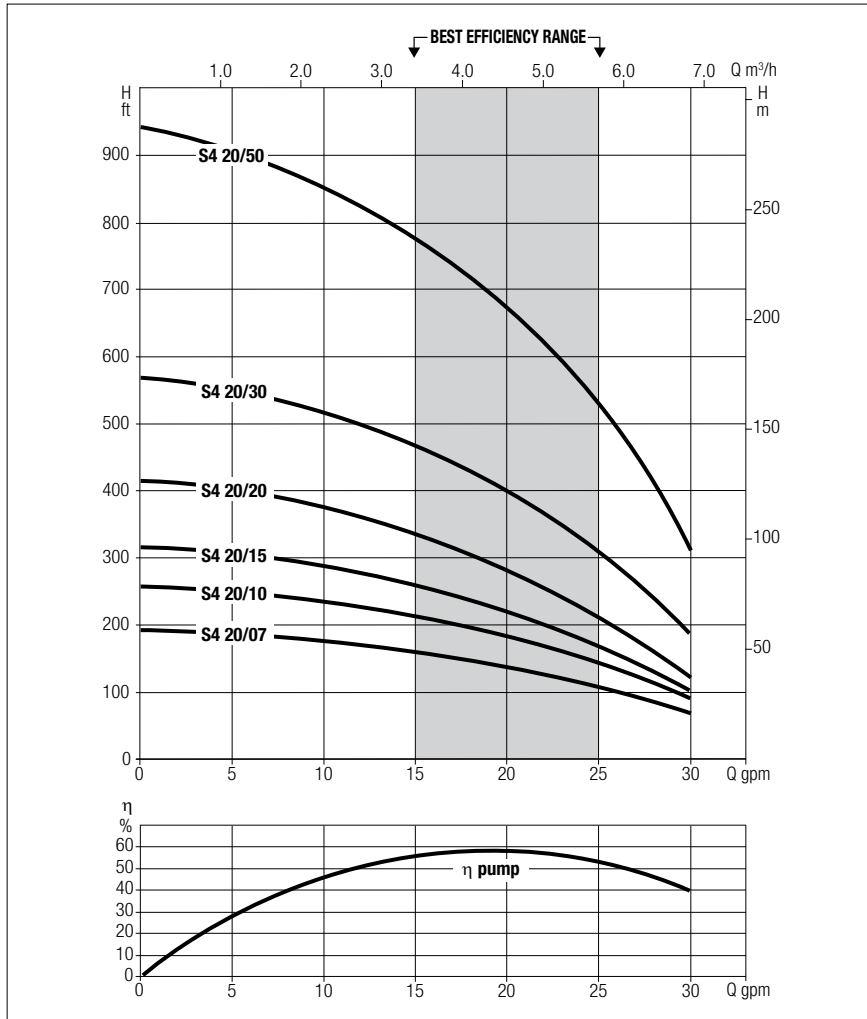

Curve tolerance according to ISO 9906

DIMENSIONS

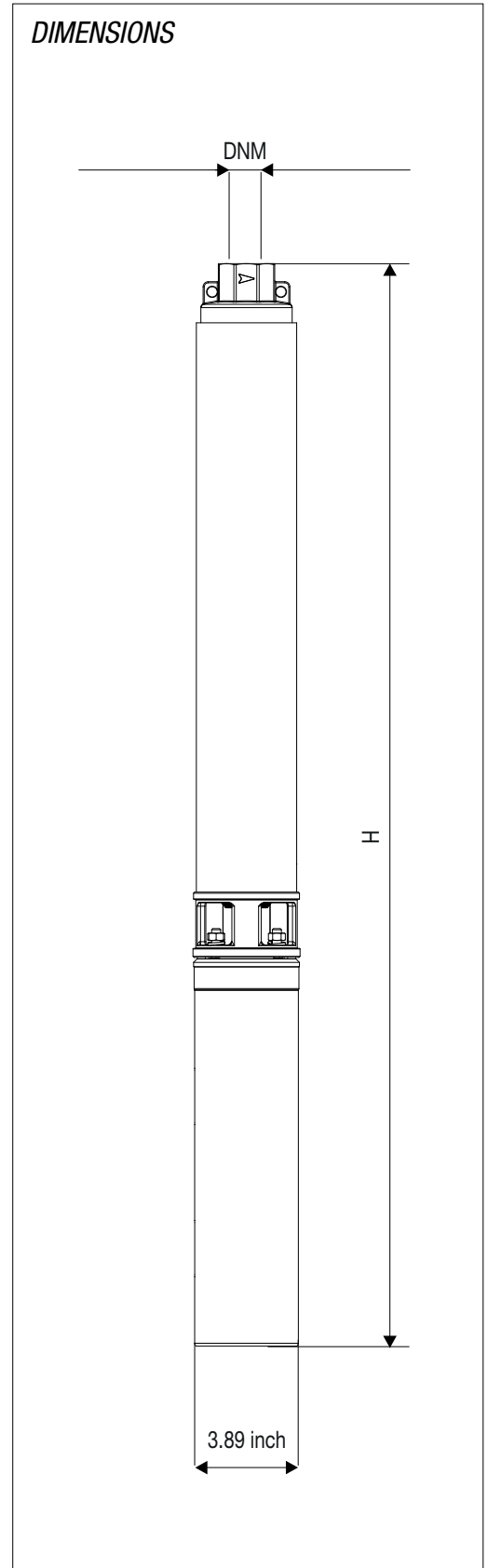

DIMENSIONS AND WEIGHTS

MODEL	H LENGTH inch	GROSS WEIGHT lbs	DISCHARGE SIZE npt
S4 20/07	14.2	6.2	1" 1/4
	28.1	29.4	
	25.5	27.6	
S4 20/10	15.3	6.6	1" 1/4
	32.0	35.3	
	28.9	34.5	
S4 20/15	18.2	9.9	1" 1/4
	36.8	42.5	
	33.6	42.3	
S4 20/20	21.3	9.3	1" 1/4
S4 20/30	26.3	11.9	1" 1/4
S4 20/50	31.1	18.3	1" 1/4

S4 25

4" SUBMERSIBLE ELECTRIC PUMPS

TECHNICAL DATA

MODEL	2 WIRE	3 WIRE	PUMP END	VOLTAGE	ASSEMBLED VERSION	MOTOR TYPE	P2 HP	STAGES
	CODE	CODE	CODE					
S4 25/10	-	-	60198630	-	-	NO MOTOR	1	7
	60199005	60199007		230	YES*	4TW 2W		
						4GG 3W		
S4 25/15	-	-	60198631	-	-	NO MOTOR	1.5	10
	60199006	60199008		230	YES*	4TW 2W		
						4GG 3W		
S4 25/20	-	-	60196240	-	-	NO MOTOR	2	13
S4 25/30	-	-	60196241	-	-	NO MOTOR	3	17
S4 25/50	-	-	60196242	-	-	NO MOTOR	5	26

* assembled version available with canned motor 4GG and 4TW

S4 25

4" SUBMERSIBLE ELECTRIC PUMPS

RANGE PERFORMANCE

MODEL	HP	PSI	Depth to pumping water in feet																								Shut-Off (ft)	
			20	40	60	80	100	120	140	160	180	200	240	260	300	360	400	480	500	600	700	800	900	1000	1100	1200		
S4 25/10	1	0	0			35	32	30	27	22	17	11																
		20	46			32	30	26	22	17	11																	
		30	69	32	28	24	21	16	8																			
		40	92	28	24	21	16	8																				
		50	116	24	20	11																						
		60	139	18	11																							
		80	185																									
Shut-off PSI			79	70	61	53	44	35	27	18	9																87	
S4 25/15	1.5	0	0					33	32	29	26	24	23	16	12													
		20	46			33	31	29	26	24	22	18	14															
		30	69		32	30	28	26	24	21	18	14	10															
		40	92	32	30	28	26	24	21	18	14	10																
		50	116	29	28	25	23	21	17	14	8																	
		60	139	27	25	22	20	17	12	8																		
		80	185	22	19	16	10																					
Shut-off PSI			121	112	103	95	86	77	69	60	51	43	25	17													129	
S4 25/20	2	0	0							33	31	30	28	24	22	17	7											
		20	46					33	31	29	27	25	23	18	16	10												
		30	69				32	31	29	27	25	23	20	15	12													
		40	92			32	30	29	27	25	23	20	18	12														
		50	116		32	30	28	26	25	22	20	18	14															
		60	139	31	30	28	26	24	22	20	16	14	10															
		80	185	27	25	24	22	19	16	12	10																	
Shut-off PSI			155	147	138	129	121	112	103	95	86	77	60	51													164	
S4 25/30	3	0	0								33	32	29	28	25	20	16											
		20	46							33	32	30	28	26	24	21	15	9										
		30	69					33	32	31	30	28	26	24	22	18	12											
		40	92				33	32	31	30	28	26	25	22	20	16	9											
		50	116			33	32	30	28	27	26	24	23	18	17	12												
		60	139		33	32	30	28	27	26	25	23	22	17	16	10												
		80	185	31	30	28	27	26	24	23	20	19	17	12	10													
Shut-off PSI			207	199	190	181	173	164	155	147	138	130	112	104	86	60	43										216	
S4 25/50	5	0	0												33	31	29	26	25	18	10							
		20	46													33	31	29	27	23	22	14						
		30	69													33	32	30	28	26	22	20	12					
		40	92													33	32	31	30	27	26	20	19	10				
		50	116													33	32	31	30	28	26	24	18	16	8			
		60	139													33	32	32	30	29	28	25	22	17	15			
		80	185							33	32	31	30	30	28	28	26	22	20	12	10							
Shut-off PSI			320	312	303	294	286	277	268	260	251	242	225	216	199	173	156	121	112	69	26					329		

NOTE: performances shown does not include friction loss in the drop pipe. All performance data is based on rated motor nameplate voltage.



S4 25

4" SUBMERSIBLE ELECTRIC PUMPS

RANGE PERFORMANCE

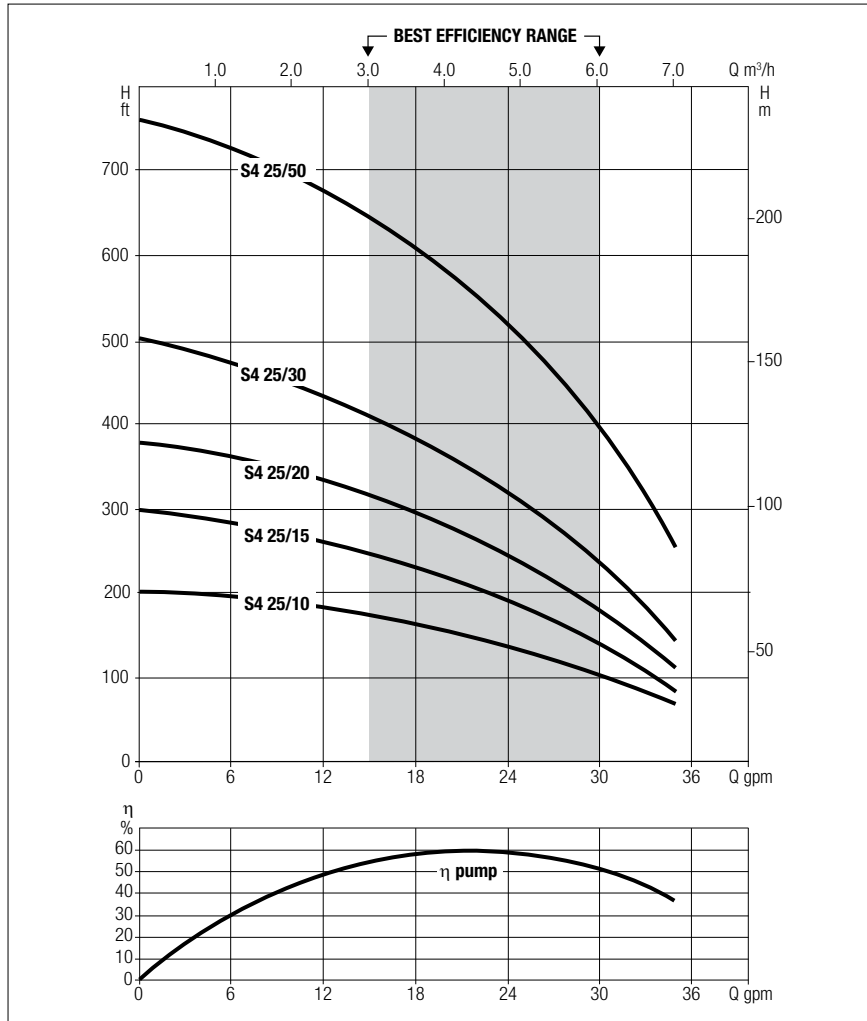

Curve tolerance according to ISO 9906

DIMENSIONS

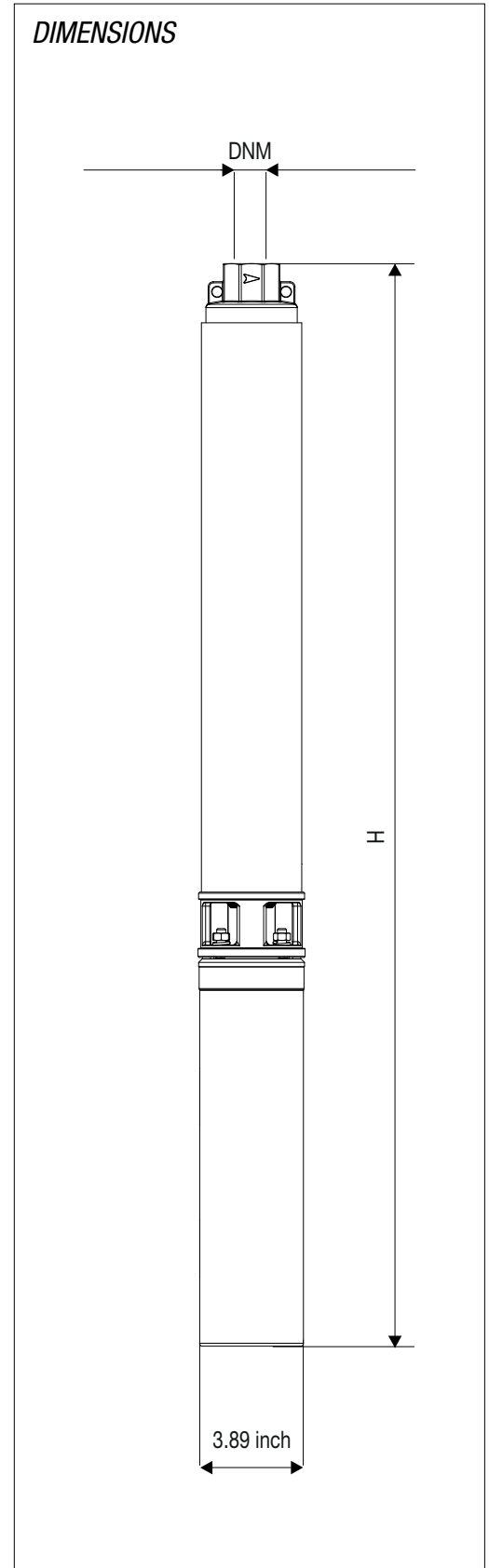

DIMENSIONS AND WEIGHTS

MODEL	H LENGTH inch	GROSS WEIGHT lbs	DISCHARGE SIZE npt
S4 25/10	17.8	7.5	1" 1/4
	34.6	36.2	
	31.4	35.4	
S4 25/15	21.9	9.0	1" 1/4
	40.5	41.7	
	37.3	41.4	
S4 25/20	26.0	10.4	1" 1/4
S4 25/30	31.4	12.1	1" 1/4
S4 25/50	42.2	19.4	1" 1/4

S4 35

4" SUBMERSIBLE ELECTRIC PUMPS

TECHNICAL DATA

MODEL	PUMP END	P2 HP	STAGES	MOTOR TYPE
	CODE			
S4 35/10	60196243	1	6	NO MOTOR
S4 35/15	60196244	1.5	8	NO MOTOR
S4 35/20	60196245	2	10	NO MOTOR
S4 35/30	60196246	3	14	NO MOTOR
S4 35/50	60196247	5	24	NO MOTOR
S4 35/75	60196248	7.5	35	NO MOTOR
S4 35/100	60196249	10	49	NO MOTOR

S4 35

4" SUBMERSIBLE ELECTRIC PUMPS

RANGE PERFORMANCE

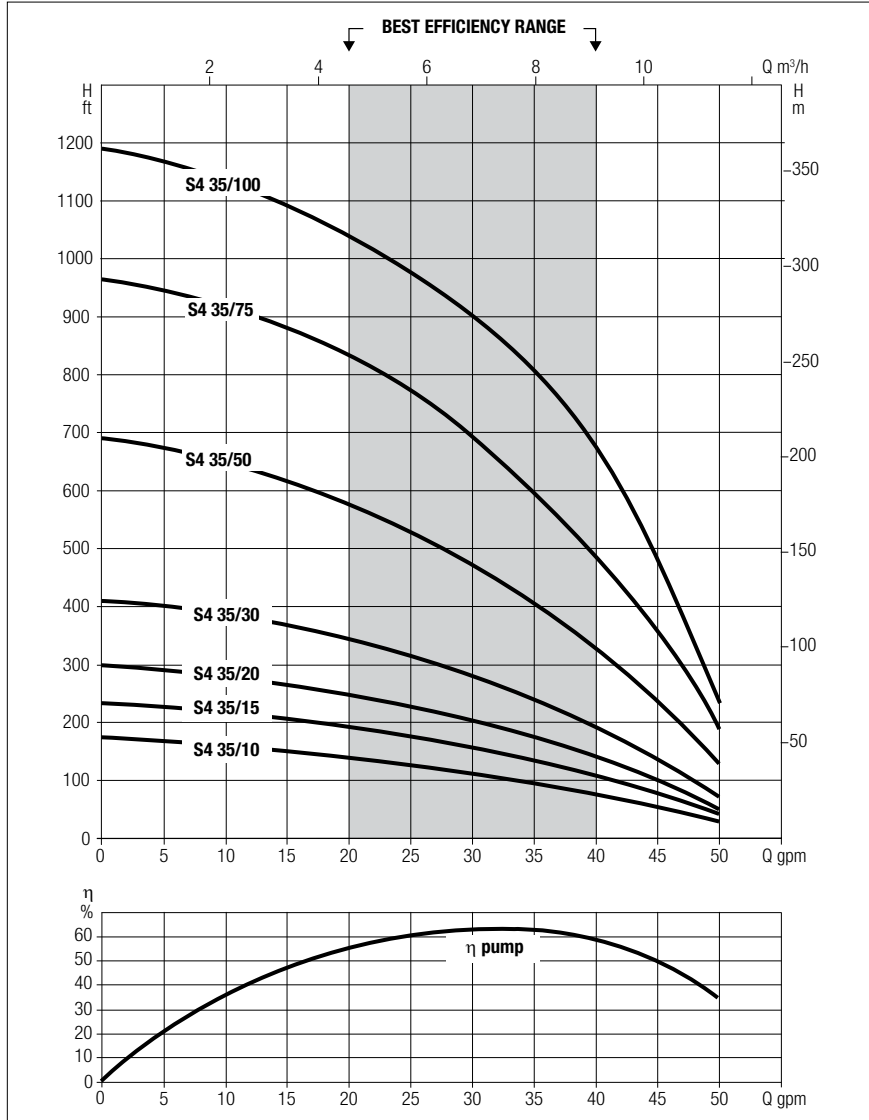

Curve tolerance according to ISO 9906

DIMENSIONS

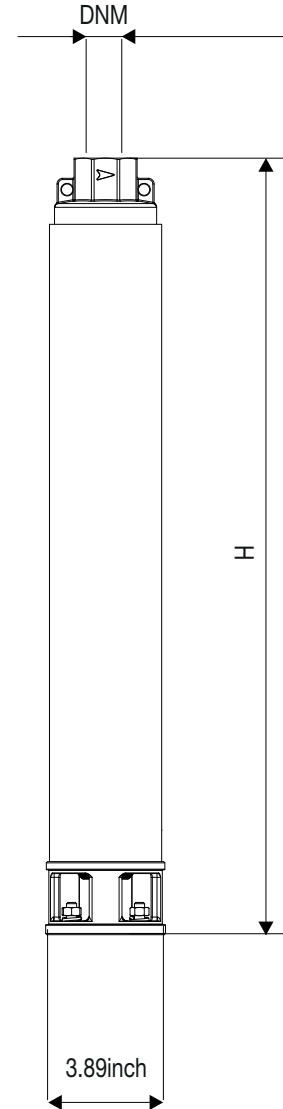

DIMENSIONS AND WEIGHTS

MODEL	H LENGTH inch	GROSS WEIGHT lbs	DISCHARGE SIZE npt
S4 35/10	16.6	7.1	2"
S4 35/15	19.2	7.9	2"
S4 35/20	21.8	9.0	2"
S4 35/30	26.9	10.8	2"
S4 35/50	38.5	18.3	2"
S4 35/75	51.9	25.1	2"
S4 35/100	68.9	34.4	2"

S4 45

4" SUBMERSIBLE ELECTRIC PUMPS

TECHNICAL DATA

MODEL	PUMP END	P2 HP	STAGES	MOTOR TYPE
	CODE			
S4 45/15	60196250	1.5	5	NO MOTOR
S4 45/20	60196251	2	7	NO MOTOR
S4 45/30	60196252	3	9	NO MOTOR
S4 45/50	60196253	5	14	NO MOTOR
S4 45/75	60196254	7.5	22	NO MOTOR
S4 45/100	60196255	10	30	NO MOTOR

S4 45

4" SUBMERSIBLE ELECTRIC PUMPS

RANGE PERFORMANCE

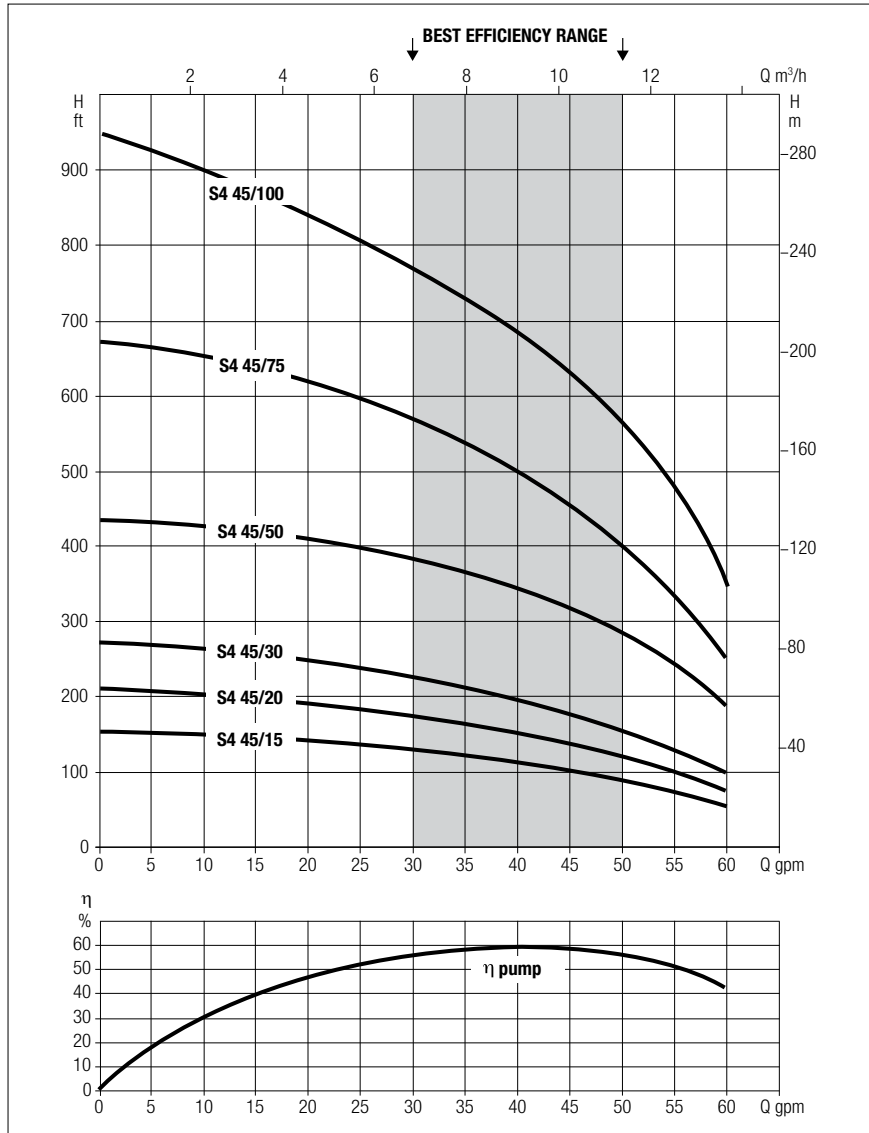

Curve tolerance according to ISO 9906

DIMENSIONS AND WEIGHTS

MODEL	H LENGHT inch	GROSS WEIGHT lbs	DISCHARGE SIZE npt
S4 45/15	15.3	6.6	2"
S4 45/20	17.9	7.5	2"
S4 45/30	20.5	8.4	2"
S4 45/50	24.8	12.1	2"
S4 45/75	36.0	18.1	2"
S4 45/100	45.8	22.9	2"

DIMENSIONS

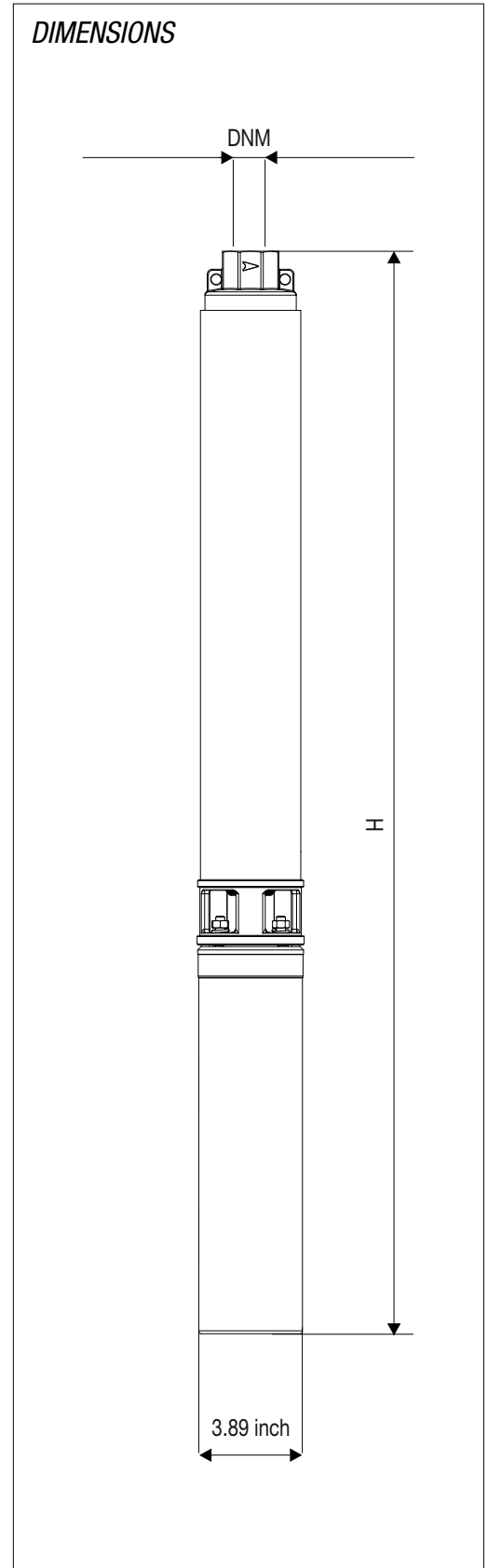

S4 60

4" SUBMERSIBLE ELECTRIC PUMPS

RANGE PERFORMANCE

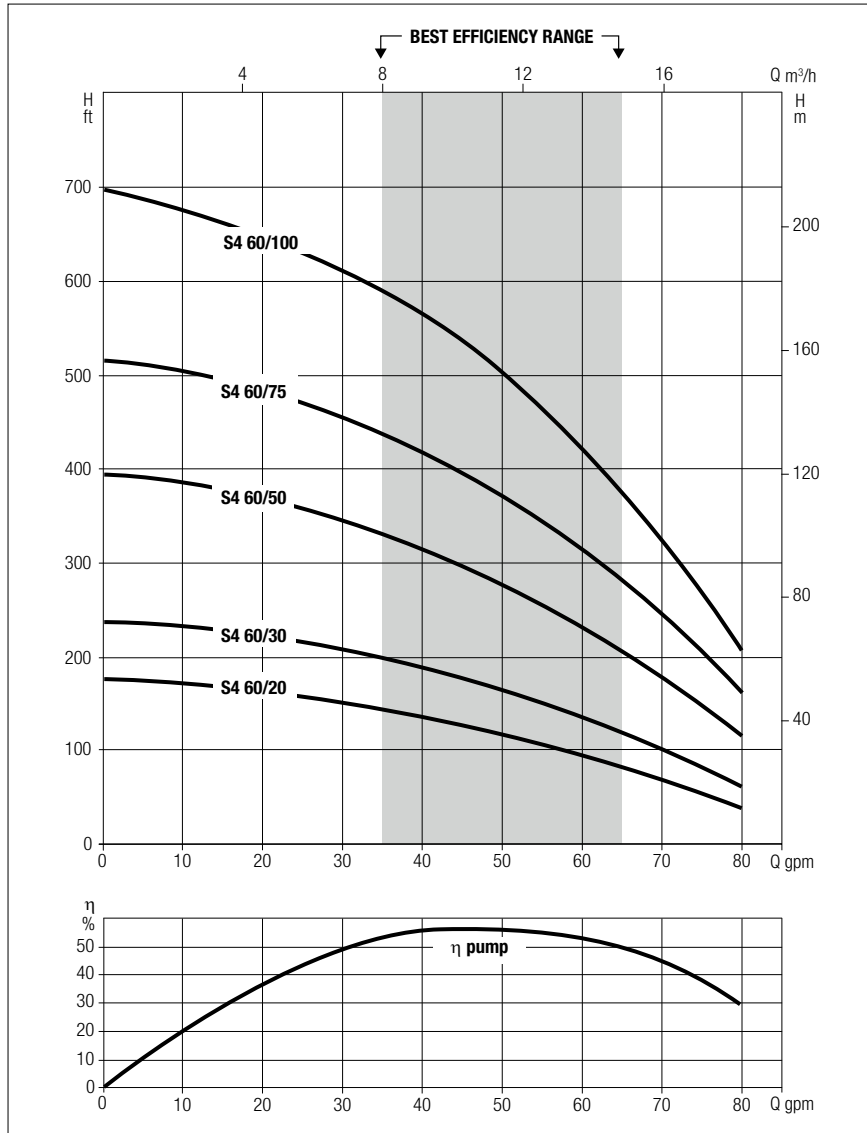

Curve tolerance according to ISO 9906

DIMENSIONS

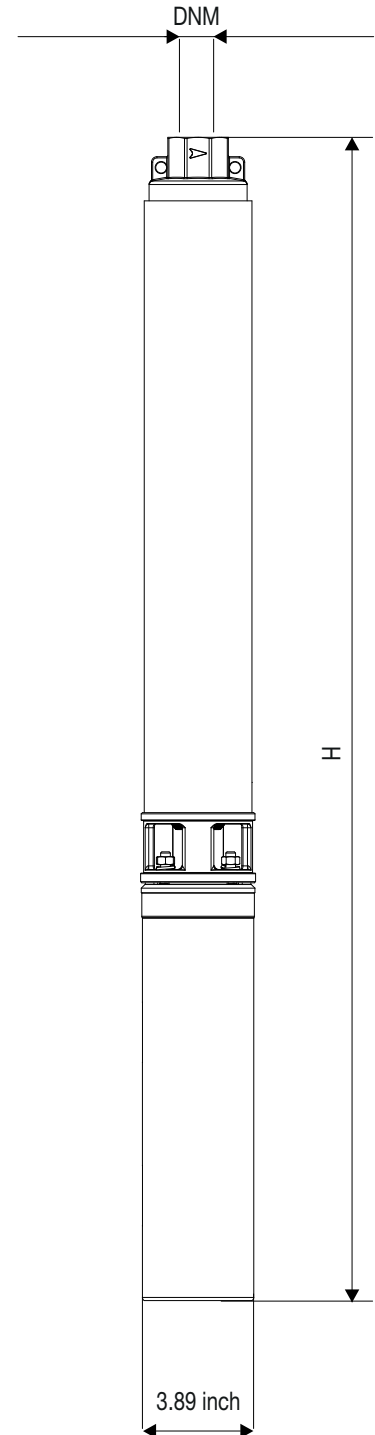

DIMENSIONS AND WEIGHTS

MODEL	H LENGHT inch	GROSS WEIGHT lbs	DISCHARGE SIZE npt
S4 60/20	21.0	9.7	2"
S4 60/30	25.1	11.5	2"
S4 60/50	34.3	16.1	2"
S4 60/75	44.0	21.4	2"
S4 60/100	56.2	28.7	2"

S4 90

4" SUBMERSIBLE ELECTRIC PUMPS

RANGE PERFORMANCE

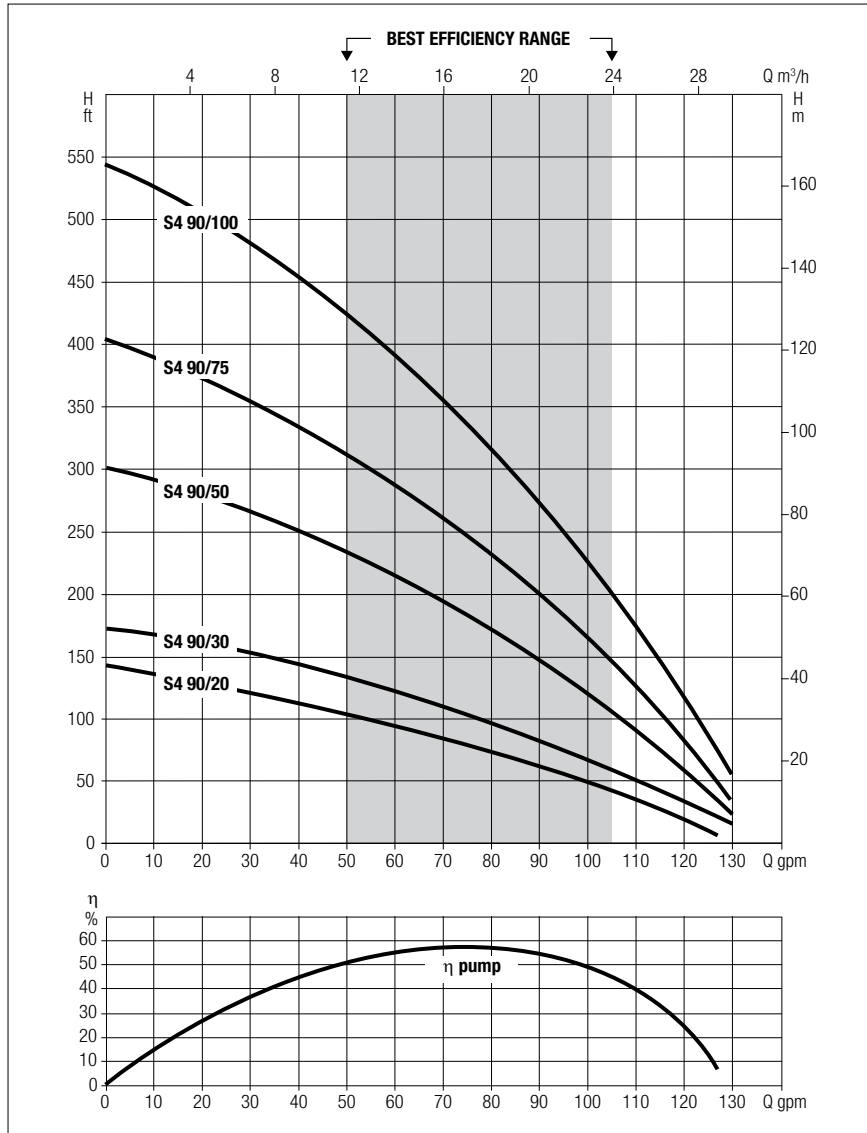

Curve tolerance according to ISO 9906

DIMENSIONS AND WEIGHTS

MODEL	H LENGHT inch	GROSS WEIGHT lbs	DISCHARGE SIZE npt
S4 90/20	22.1	9.7	2"
S4 90/30	24.8	10.8	2"
S4 90/50	34.5	17.2	2"
S4 90/75	46.7	22.7	2"
S4 90/100	60.1	28.9	2"

DIMENSIONS

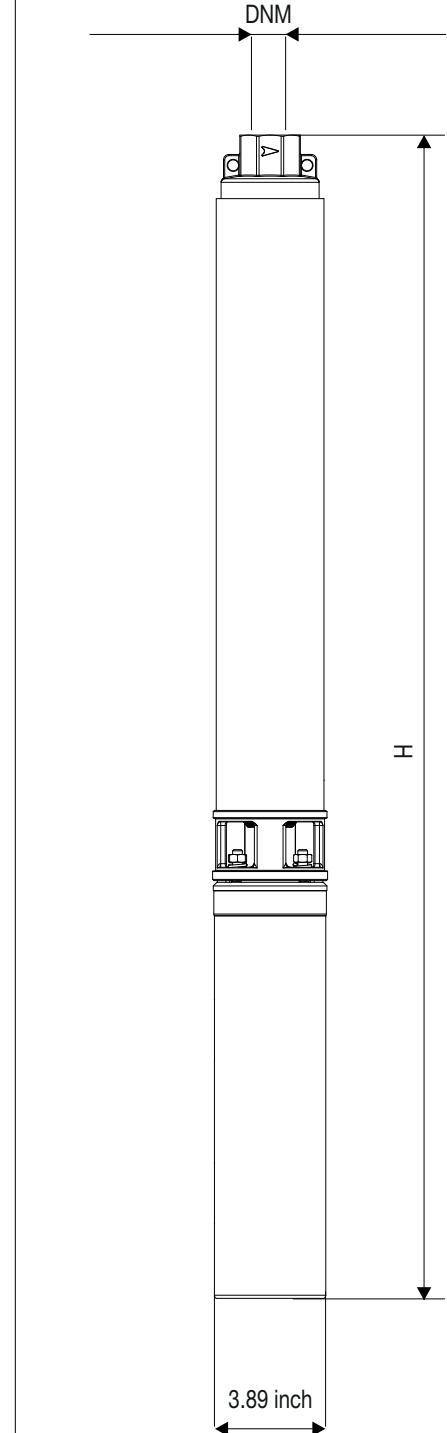

S4

4" SUBMERSIBLE ELECTRIC PUMPS

REPLACEMENT TABLE

S4 5	
MODEL	CODE
2BF51-5	BF-0512-112
2BF52-5	BF-0512-122
2BF72-5	BF-0515-122
2BF102-5	BF-0520-122
2BF152-5	BF-0526-122
3BF51-5	BF-0512-113
3BF52-5	BF-0512-123
3BF72-5	BF-0515-123
3BF102-5	BF-0520-132
3BF152-5	BF-0526-132
BF5-5	BF-0512-000
BF7-5	BF-0515-000
BF10-5	BF-0520-000
BF15-5	BF-0526-000
BFHC20-5	BF-0533-000

S4 5	
MODEL	CODE
S4 5/05	60198632
S4 5/05	60198636
S4 5/07	60198637
S4 5/10	60198638
S4 5/15	60198639
S4 5/05	60198655
S4 5/05	60198659
S4 5/07	60198660
S4 5/10	60198661
S4 5/15	60198662
S4 5/05	60198611
S4 5/07	60198612
S4 5/10	60198613
S4 5/15	60198614
S4 5/20	60196210

S4 7	
MODEL	CODE
2BF51-7	BF-0710-112
2BF52-7	BF-0710-122
2BF72-7	BF-0713-122
2BF102-7	BF-0717-122
2BF152-7	BF-0722-122
3BF51-7	BF-0710-113
3BF52-7	BF-0710-123
3BF72-7	BF-0713-123
3BF102-7	BF-0717-123
3BF152-7	BF-0722-123
BF5-7	BF-0710-000
BF7-7	BF-0713-000
BF10-7	BF-0717-000
BF15-7	BF-0722-000
BFHC20-7	BF-0727-000
BFHC30-7	BF-0734-000

S4 7	
MODEL	CODE
S4 7/05	60198633
S4 7/05	60198640
S4 7/07	60198641
S4 7/10	60198642
S4 7/15	60198643
S4 7/05	60198656
S4 7/05	60198663
S4 7/07	60198664
S4 7/10	60198665
S4 7/15	60198666
S4 7/05	60198615
S4 7/07	60198616
S4 7/10	60198617
S4 7/15	60198618
S4 7/20	60196215
S4 7/30	60196216

S4 10	
MODEL	CODE
2BF51-10	BF-1007-112
2BF52-10	BF-1007-122
2BF72-10	BF-1010-122
2BF102-10	BF-1012-122
2BF152-10	BF-1017-122
3BF51-10	BF-1007-113
3BF52-10	BF-1007-123
3BF72-10	BF-1010-123
3BF102-10	BF-1012-123
3BF152-10	BF-1017-123
BF5-10	BF-1007-000
BF7-10	BF-1010-000
BF10-10	BF-1012-000
BF15-10	BF-1017-000
BFHC20-10	BF-1020-000
BFHC30-10	BF-1027-000
BFHC50-10	BF-1042-000

S4 10	
MODEL	CODE
S4 10/05	60198634
S4 10/05	60198644
S4 10/07	60198645
S4 10/10	60198646
S4 10/15	60198647
S4 10/05	60198657
S4 10/05	60198667
S4 10/07	60198668
S4 10/10	60198669
S4 10/15	60198670
S4 10/05	60198619
S4 10/07	60198620
S4 10/10	60198621
S4 10/15	60198622
S4 10/20	60196222
S4 10/30	60196223
S4 10/50	60196224

S4 15	
MODEL	CODE
2BF51-15	BF-1505-112
2BF52-15	BF-1505-122
2BF72-15	BF-1507-122
2BF102-15	BF-1510-122
2BF152-15	BF-1512-122
3BF51-15	BF-1505-113
3BF52-15	BF-1505-123
3BF72-15	BF-1507-123
3BF102-15	BF-1510-123
3BF152-15	BF-1512-123
BF5-15	BF-1505-000
BF7-15	BF-1507-000
BF10-15	BF-1510-000
BF15-15	BF-1512-000
BFHC20-15	BF-1517-000
BFHC30-15	BF-1521-000
BFHC50-15	BF-1535-000

S4 15	
MODEL	CODE
S4 15/05	60198635
S4 15/05	60198648
S4 15/07	60198649
S4 15/10	60198650
S4 15/15	60198651
S4 15/05	60198658
S4 15/05	60198671
S4 15/07	60198672
S4 15/10	60198673
S4 15/15	60198674
S4 15/05	60198623
S4 15/07	60198624
S4 15/10	60198625
S4 15/15	60198626
S4 15/20	60196229
S4 15/30	60196230
S4 15/50	60196231

S4

4" SUBMERSIBLE ELECTRIC PUMPS

REPLACEMENT TABLE

S4 20	
MODEL	CODE
2BF51-20	BF-2005-112
2BF52-20	BF-2005-122
2BF72-20	BF-2006-122
2BF102-20	BF-2008-122
2BF152-20	BF-2011-122
3BF51-20	BF-2005-113
3BF52-20	BF-2005-123
3BF72-20	BF-2006-123
3BF102-20	BF-2008-123
3BF152-20	BF-2011-123
BF5-20	BF-2005-000
BF7-20	BF-2006-000
BF10-20	BF-2008-000
BF15-20	BF-2011-000
BFHC20-20	BF-2014-000
BFHC30-20	BF-2019-000
BFHC50-20	BF-2030-000

S4 20	
MODEL	CODE
S4 20/07	60198652
S4 20/10	60198653
S4 20/15	60198654
S4 20/07	60198675
S4 20/10	60198676
S4 20/15	60198677
S4 20/07	60198627
S4 20/10	60198628
S4 20/15	60198629
S4 20/20	60196235
S4 20/30	60196236
S4 20/50	60196237

S4 25	
MODEL	CODE
2BF102-30	BF-3007-122
2BF152-30	BF-3009-122
3BF102-30	BF-3007-123
3BF152-30	BF-3009-123
BF10-30	BF-3007-000
BFHC15-30	BF-3009-000
BFHC20-30	BF-3011-000
BFHC30-30	BF-3015-000
BFHC50-30	BF-3026-000

S4 25	
MODEL	CODE
S4 25/10	60199005
S4 25/15	60199006
S4 25/10	60199007
S4 25/15	60199008
S4 25/10	60198630
S4 25/15	60198631
S4 25/20	60196240
S4 25/30	60196241
S4 25/50	60196242

S4 35	
MODEL	CODE
BF10-35	BF-3506-000
BFHC15-35	BF-3508-000
BFHC20-35	BF-3510-000
BFHC30-35	BF-3514-000
BFHC50-35	BF-3522-000
BFHC75-35	BF-3534-000
BFHC100-35	BF-3543-000

S4 35	
MODEL	CODE
S4 35/10	60196243
S4 35/15	60196244
S4 35/20	60196245
S4 35/30	60196246
S4 35/50	60196247
S4 35/75	60196248
S4 35/100	60196249

S4 60	
MODEL	CODE
BFHC15-55	BF-5505-000
BFHC20-55	BF-5507-000
BFHC30-55	BF-5509-000
BFHC50-55	BF-5515-000
BFHC75-55	BF-5522-000
BFHC100-55	BF-5529-000

S4 60	
MODEL	CODE
S4 60/20	60196256
S4 60/30	60196257
S4 60/50	60196258
S4 60/75	60196259
S4 60/100	60196260

S4 90	
MODEL	CODE
BFHC20-95	BF-9503-000
BFHC30-95	BF-9505-000
BFHC50-95	BF-9509-000
BFHC75-95	BF-9514-000

S4 90	
MODEL	CODE
S4 90/20	60196261
S4 90/30	60196262
S4 90/50	60196263
S4 90/75	60196264

S4

4" SUBMERSIBLE ELECTRIC PUMPS

HYDRAULIC EFFICIENCY

US DOE, S PUMPS ENERGY CONSERVATION STANDARDS

GENERAL INFORMATION

The "S4" pumps are compliant with US DOE, s Pumps energy conservation standards:

- 431.462 Clean water pump
- 431.464 Test procedure for the measurement of energy efficiency, energy consumption, and other performance factors of pumps.
- 431.465 Pumps energy conservation standards and their compliance dates.
- 431.466 Pumps labeling requirements.

The testing and labelling is done by DAB as per the following test procedure, no certification body involvement required for USA.

Appendix A to Subpart Y of Part 431—Uniform Test Method for the Measurement of Energy Consumption of Pumps.

For more info: www.ecfr.gov

BEP US gpm	P2 KW	P2 HP	DAB Model (Pump End DAB)	STAGES	PEI pump end	PEI Hydraulic + 2W motor 230 V	PEI Hydraulic + 3W motor 230 V
25	0.75	1	S 25/10	7	0.98	1	0.98
	1.1	1.5	S 25/15	10	0.88	0.97	0.92
	1.5	2	S 25/20	13	0.87		
	2.2	3	S 25/30	17	0.93		
	3.7	5	S 25/50	26	0.9		
35	0.75	1	S 35/10	6	0.94		
	1.1	1.5	S 35/15	8	0.9		
	1.5	2	S 35/20	10	0.89		
	2.2	3	S 35/30	14	0.9		
	3.7	5	S 35/50	24	0.88		
	5.5	7.5	S 35/75	35	0.92		
	7.5	10	S 35/100	49	0.92		
45	1.1	1.5	S 45/15	5	0.98		
	1.5	2	S 45/20	7	0.96		
	2.2	3	S 45/30	9	0.97		
	3.7	5	S 45/50	14	0.92		
	5.5	7.5	S 45/75	22	0.94		
	7.5	10	S 45/100	30	0.94		
60	1.5	2	S 60/20	6	1		
	2.2	3	S 60/30	8	1		
	3.7	5	S 60/50	13	0.98		
	5.5	7.5	S 60/75	17	1		
	7.5	10	S 60/100	23	1		
90	1.5	2	S 90/20	5	1		
	2.2	3	S 90/30	6	1		
	3.7	5	S 90/50	10	1		
	5.5	7.5	S 90/75	14	1		
	7.5	10	S 90/100	19	0.96		

4TW

SUBMERSIBLE MOTOR 4"



4" Asynchronous two-poles submersible motor, made in AISI 304 stainless steel for parts in contact with water. Cooling and lubrication of the thrust bearing assembly and carbon bushes is provided by a mixture of water and glycol. Squirrel-cage rotor mounted on Kingsbury self-centring thrust bearing. Stator housed in an airtight stainless steel casing (canned-type) with both flanges and shell in AISI 304L stainless steel.

On request is available the **4TWX** version made entirely in stainless steel AISI 316.

Removable cable connector to allow fast and easy maintenance. The cable is certified ACS, WRAS and KTW. Motor suitable for use with variable frequency drive (30 Hz – 50/60 Hz). The capacitor is placed in the Noryl cartridge directly connected to the motor, so the motor doesn't require an external control box. Thermal protection included in the motor from 0.5 HP to 1.5 HP in the 50 Hz version, from 0.5 HP to 1 HP in the 230 V - 60 Hz version.

Flange NEMA 4"

Insulation class F

Protection class IP68

Cooling flow speed 1.0 ft/sec @ 95 °F

Power supply tolerance + 6 % / -10 %

Max. starts 20/h

Max operating depth 984 ft

Horizontal operation 0.5 HP - 1.5 HP

Motor maximum diameter 3.9"



TECHNICAL DATA - SINGLE PHASE MOTORS

MODEL	CODE	V [V]	P2		SF	In [A]	In (SF) [A]	Is/In	Cs/Cn	P1 [W]	N [min ⁻¹]	Cos φ	η %	C [μF]	Ø [AWG]	LC [ft]
			[HP]	[kW]												
4TW - 0.5 HP	60174194	115	0.5	0.37	1.6	8.6	10	4.2	0.65	800	3450	0.88	46	80	3x14	5½
4TW - 0.5 HP	60174195	230			1.6	3.9	5	4.6	0.65	800	3450	0.88	46	20	3x14	5½
4TW - 0.75 HP	60174196	230	0.75	0.55	1.5	6.3	6.9	4.3	0.65	1200	3450	0.82	47	25	3x14	5½
4TW - 1 HP	60174197	230	1	0.75	1.4	7.7	8.8	4.8	0.68	1500	3450	0.84	50	35	3x14	5½
4TW - 1.5 HP	60174198	230	1.5	1.1	1.3	11.8	12.7	4.7	0.7	2120	3450	0.85	53	40	3x14	5½

- V: Rated voltage
- P2: Rated output
- SF: Service factor
- In: Rated current
- In (SF): Service factor current
- Is/In: Locked rotor current/Rated current
- Cs/Cn: Locked rotor Torque/Rated Torque
- P1: Power consumption
- N: R.P.M
- Cos φ: Power factor
- η: Efficiency
- C: Capacitor
- Ø: Cable section
- LC: Cable length

4TW

SUBMERSIBLE MOTOR 4"

DIMENSIONS AND WEIGHTS - SINGLE PHASE MOTORS

MODEL	L LENGTH inch	WEIGHT lbs	AXIAL THRUST lbf	Q.TY x PALLET
4TW - 0.5 HP - 0.37kW	13.425	21.4	500	N/A
4TW - 0.5 HP - 0.37kW	13.031	21.0	500	N/A
4TW - 0.75 HP - 0.55kW	13.819	23.2	500	N/A
4TW - 1 HP - 0.75kW	16.772	28.9	700	N/A
4TW - 1.5 HP - 1.1kW	18.543	33.3	700	N/A

POS.	inch
A	0.61
B	0.591
C	0.906
D	1 1/2"
E	1.465
F	3"
G	3.437

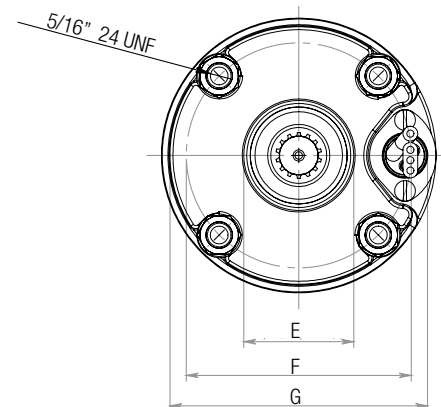
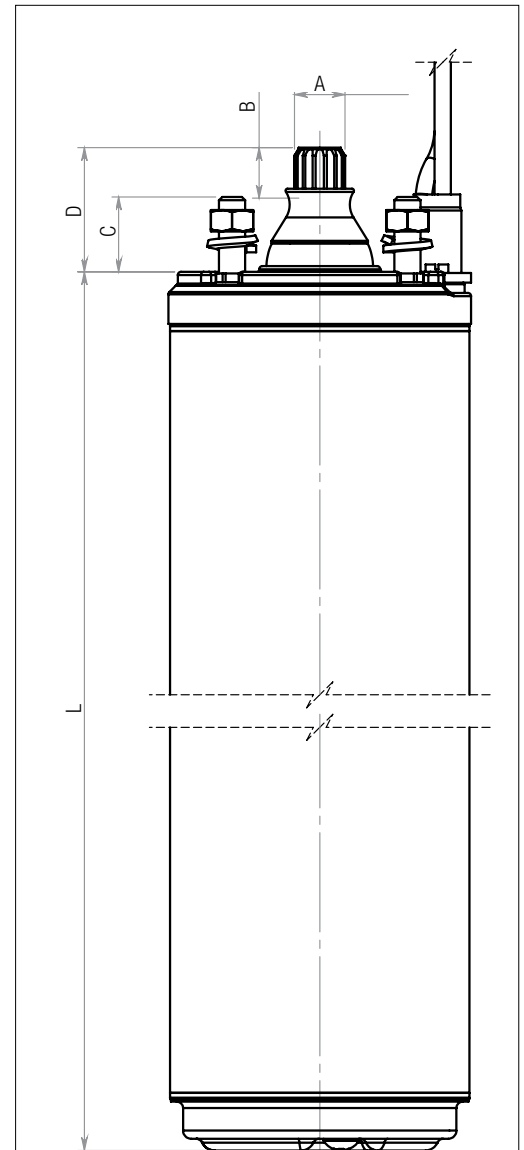

USA VERSION

KIT CABLE CONNECTOR	DESCRIPTION	CODE
	KIT CABLE - FT 5,58 <ul style="list-style-type: none"> • CABLES WITH DIFFERENT LENGTH • DIFFERENT SUPPLY VOLTAGES • CSA CERTIFIED VERSION 	60141970



4GG

SUBMERSIBLE MOTOR 4"



4" Asynchronous two-poles submersible motor, made in AISI 304 stainless steel for parts in contact with water. Cooling and lubrication of the thrust bearing assembly and carbon bushes is provided by a mixture of water and glycol. Squirrel-cage rotor mounted on Kingsbury self-centring thrust bearing. Stator housed in an airtight stainless steel casing (canned-type) with both flanges and shell in AISI 304L stainless steel.

Removable cable connector to allow fast and easy maintenance. The cable is certified ACS, WRAS and KTW. Motor suitable for use with variable frequency drive (30 Hz – 50/60 Hz). Capacitor and manually resettable overload protection located in the electric panel that can be supplied separately for the single-phase 50 Hz version. For the single-phase 60 Hz version the thermal protection is included in the motor (from 0.5 HP to 1 HP). Overload protection must be provided by user for the three-phase version.

Flange NEMA 4"

Insulation class F

Degree of protection IP68

Cooling flow 1.0 ft³/sec @ 95 °F

Voltage tolerance + 6% / -10%

Max starts 20/h

Max operating depth 984 ft

Horizontal operation 0.5 HP - 10 HP

Motor maximum diameter 3.9"



ACCESSORIES
PAG. 127

TECHNICAL DATA - SINGLE PHASE MOTORS

MODEL	3 WIRE	V [V]	P2		SF	In [A]	In (SF) [A]	Is/In	Cs/Cn	P1 [W]	N [min ⁻¹]	Cos φ	η %	C1 [μF]	C2 [μF]	Ø [AWG]	LC [ft]
	CODE		[HP]	[kW]													
4GG - 1/2 HP	60174199	115	0.5	0.37	1.6	10.0	12.6	4.0	3.2	800	3450	0.71	48	-	250-300	4x14	5½
4GG - 1/2 HP	60174200	230			1.6	5.5	6.8	4.2	3.9	800	3450	0.62	46	-	59-71	4x14	5½
4GG - 3/4 HP	60174201	230	0.75	0.55	1.5	7.4	8.6	4.6	3.6	1100	3450	0.65	53	-	86-103	4x14	5½
4GG - 1 HP	60174202	230	1	0.75	1.4	8.0	9.8	5.5	2.9	1350	3450	0.68	58	-	105-126	4x14	5½
4GG - 1 1/2 HP	60174203	230	1.5	1.1	1.3	10.0	12.0	6.0	1.9	1800	3450	0.81	64	10	105-126	4x14	5½
4GG - 2 HP	60174204	230	2	1.5	1.25	10.5	12.3	5.3	2.3	2200	3450	0.95	69	20	105-126	4x14	5½
4GG - 3 HP	60174205	230	3	2.2	1.15	14.3	16.2	5.5	2.1	3100	3450	0.97	72	45	208-250	4x14	5½
4GG - 5 HP	60174206	230	5	3.7	1.15	22.2	25.5	5.5	1.8	5000	3450	0.99	74	2x40	270-324	4x14	8¾

- V: Rated voltage
- P2: Rated output
- SF: Service factor
- In: Rated current
- In (SF): Service factor current
- Is/In: Locked rotor current/Rated current
- Cs/Cn: Locked rotor Torque/Rated Torque
- P1: Power consumption
- N: R.P.M
- Cos φ: Power factor
- η: Efficiency
- C: Capacitor
- Ø: Cable section
- LC: Cable length

4GG

SUBMERSIBLE MOTOR 4"

TECHNICAL DATA - THREE PHASE MOTORS

MODEL	3 WIRE	V [V]	P2		SF	In [A]	In (SF) [A]	Is/In	Cs/Cn	P1 [W]	N [min ⁻¹]	Cos φ	η %	C [μF]	CABLE	
	CODE		[HP]	[kW]											∅ [AWG]	LC [ft]
4GG - 1/2 HP	60121248	230	0.5	0.37	1.6	3.2	3.8	4.4	3.2	870	3450	0.4	42	-	4x14	5½
	60140361	460			1.6	1.6	1.9	5	3.2	870	3450	0.4	42	-	4x14	5½
	TBD	575			1.6	1.3	1.5	5	3.2	650	3450	0.54	57	-	4x14	5½
4GG - 3/4 HP	60121249	230	0.75	0.55	1.5	4.4	4.8	5.2	3.6	1140	3450	0.47	48	-	4x14	5½
	60121252	460			1.5	2.2	2.4	5.5	3.6	1140	3450	0.47	48	-	4x14	5½
	TBD	575			1.5	1.8	1.9	5.5	3.6	840	3450	0.48	65	-	4x14	5½
4GG - 1 HP	60121254	230	1	0.75	1.4	5.2	5.6	6.4	4.2	1260	3450	0.59	59	-	4x14	5½
	60121256	460			1.4	2.6	2.8	5.8	4.2	1260	3450	0.59	59	-	4x14	5½
	TBD	575			1.4	2.1	2.2	5.8	4.2	1200	3450	0.59	63	-	4x14	5½
4GG - 1 1/2 HP	60140362	230	1.5	1.1	1.3	7.2	7.8	5.9	4.1	1875	3450	0.53	60	-	4x14	5½
	60121259	460			1.25	3.6	3.9	6.7	4.1	1875	3450	0.53	60	-	4x14	5½
	TBD	575			1.3	2.9	3.1	6.7	4.1	1720	3450	0.60	64	-	4x14	5½
4GG - 2 HP	60140363	230	2	1.5	1.15	9.2	9.8	6.1	3.8	2230	3450	0.57	67	-	4x14	5½
	60121268	460			1.15	4.6	4.9	6.7	3.8	2230	3450	0.57	67	-	4x14	5½
	TBD	575			1.25	3.7	6.1	6.7	3.8	2160	3450	0.59	69	-	4x14	5½
4GG - 3 HP	60140364	230	3	2.2	1.15	11.2	12	7.5	4.8	3160	3450	0.69	71	-	4x14	5½
	60140365	460			1.15	5.6	6	7.1	4.8	3160	3450	0.69	71	-	4x14	5½
	TBD	575			1.15	4.5	4.8	7.1	4.8	3050	3450	0.68	72	-	4x14	5½
4GG - 5 HP	60140368	230	5	4	1.15	17.8	19.2	7.4	4	5230	3450	0.7	77	-	4x14	8¾
	60140369	460			1.15	8.9	9.6	7.4	4	5230	3450	0.7	77	-	4x14	8¾
	TBD	575			1.15	7.1	7.7	7.4	4.4	5300	3450	0.75	75	-	4x14	8¾
4GG - 7.5 HP	60140370	230	7.5	5.5	1.15	24	26	7.5	3.8	7100	3450	0.71	78	-	4x14	8¾
	60140371	460			1.15	12	13	7.5	3.8	7100	3450	0.71	78	-	4x14	8¾
	TBD	575			1.15	9.6	10.4	7.5	3.8	7050	3450	0.74	79	-	4x14	8¾
4GG - 10 HP	60140372	460	10	7.5	1.15	15.4	16.6	7.1	3.9	9300	3450	0.78	80	-	4x14	11½
	TBD	575			1.15	12.3	13.5	7.1	3.9	9100	3450	0.74	82	-	4x14	11½

P2: Rated output
V: Rated voltage
SF: Service factor
In: Rated current
In (SF): Service factor current

Is/In: Locked rotor current/Rated current
Cs/Cn: Locked rotor Torque/Rated Torque
P1: Power consumption
N: R.P.M
Cos φ: Power factor

η: Efficiency
C: Capacitor
∅: Cable section
LC: Cable length



4GG

SUBMERSIBLE MOTOR 4"

DIMENSIONS AND WEIGHTS - SINGLE PHASE MOTORS

MODEL	L LENGTH inch	WEIGHT lbs	AXIAL THRUST lbf	Q.TY x PALLET
4GG - 1/2 HP - 0.37kW	10.472	19.4	500	N/A
4GG - 3/4 HP - 0.55kW	11.26	21.4	500	N/A
4GG - 1 HP - 0.75kW	13.622	27.8	700	N/A
4GG - 1 1/2 HP - 1.1kW	16.181	32.5	700	N/A
4GG - 2 HP - 1.5kW	16.181	32.7	700	N/A
4GG - 3 HP - 2.2kW	21.417	45.2	1500	N/A
4GG - 5 HP - 3.7kW	26.929	59.8	1500	N/A

DIMENSIONS AND WEIGHTS - THREE PHASE MOTORS

MODEL	L LENGTH inch	WEIGHT lbs	AXIAL THRUST lbf	Q.TY x PALLET
4GG - 1/2 HP - 0.37kW	9.291	16.3	500	N/A
4GG - 3/4 HP - 0.55kW	10.472	19.4	500	N/A
4GG - 1 HP - 0.75kW	11.26	21.4	500	N/A
4GG - 1 1/2 HP - 1.1kW	13.622	25.8	700	N/A
4GG - 2 HP - 1.5kW	15.394	30.5	700	N/A
4GG - 3 HP - 2.2kW	19.843	40.8	1500	N/A
4GG - 5 HP - 3.7kW	24.173	51.9	1500	N/A
4GG - 7.5 HP - 5.5kW	26.929	59.8	1500	N/A
4GG - 10 HP - 7.5kW	30.079	68.7	1500	N/A

POS.	inch	POS.	inch	POS.	inch
A	0.610	D	1 1/2"	F	3"
B	0.591	E	1.465	G	3 3/8"
C	7/8"				

KIT CABLE CONNECTOR USA VERSION	DESCRIPTION	CODE
	KIT CABLE CONNECTOR - FT 5.58	60141967
	KIT CABLE CONNECTOR - FT 8.86	60141968
	KIT CABLE CONNECTOR - FT 9.84	60141969

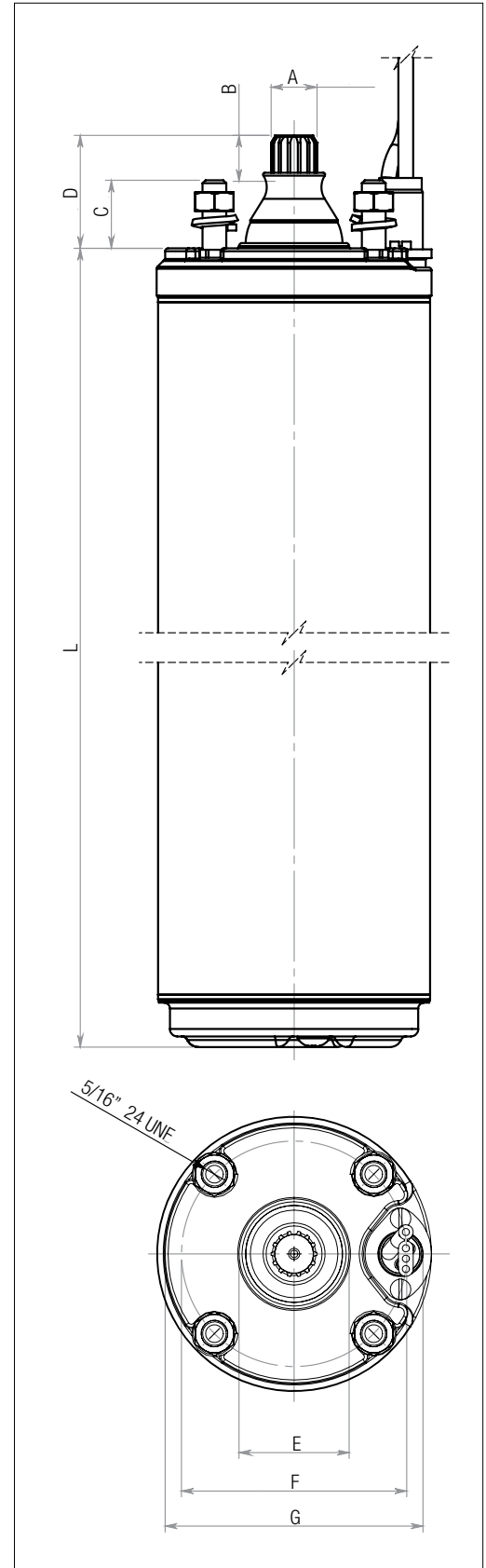

4GX

SUBMERSIBLE MOTOR 4"



4" Asynchronous two-poles submersible motor, made in AISI 304 stainless steel for parts in contact with water. Cooling and lubrication of the thrust bearing assembly and carbon bushes is provided by a mixture of water and glycol. Squirrel-cage rotor mounted on Kingsbury self-centring thrust bearing. Stator housed in an airtight stainless steel casing (canned-type) with both flanges and shell in AISI 304L stainless steel.

Removable cable connector to allow fast and easy maintenance. The cable is certified ACS, WRAS and KTW. Motor suitable for use with variable frequency drive (30 Hz – 50/60 Hz). Capacitor and manually resettable overload protection located in the electric panel that can be supplied separately for the single-phase 50 Hz version. For the single-phase 60 Hz version the thermal protection is included in the motor (from 0.5 HP to 1 HP). Overload protection must be provided by user for the three-phase version.

Flange NEMA 4"

Insulation class F

Degree of protection IP68

Cooling flow 1.0 ft/sec @ 95 °F

Voltage tolerance + 6% / -10%

Max starts 20/h

Max operating depth 984 ft

Horizontal operation 0.5 HP - 10 HP

Motor maximum diameter 3.9"



ACCESSORIES
PAG. 127

TECHNICAL DATA - SINGLE PHASE MOTORS

MODEL	3 WIRE		P2		SF	In [A]	In (SF) [A]	Is/In	CsCn	P1 [W]	N [min ⁻¹]	Cos φ	η %	C1 [μF]	C2 [μF]	Ø [AWG]	LC [ft]
	CODE	[HP]	[kW]														
4GX - 1/2 HP	TBD				1.6	10.0	12.6	4.0	3.2	800	3450	0.71	48	-	250-300	4x14	5½
4GX - 1/2 HP	TBD		0.5	0.37	1.6	5.5	6.8	4.2	3.9	800	3450	0.62	46	-	59-71	4x14	5½
4GX - 3/4 HP	60143815		0.75	0.55	1.5	7.4	8.6	4.6	3.6	1100	3450	0.65	53	-	86-103	4x14	5½
4GX - 1 HP	60143816		1	0.75	1.4	8.0	9.8	5.5	2.9	1350	3450	0.68	58	-	105-126	4x14	5½
4GX - 1 1/2 HP	60143817		1.5	1.1	1.3	10.0	12.0	6.0	1.9	1800	3450	0.81	64	10	105-126	4x14	5½
4GX - 2 HP	TBD		2	1.5	1.25	10.5	12.3	5.3	2.3	2200	3450	0.95	69	20	105-126	4x14	5½
4GX - 3 HP	TBD		3	2.2	1.15	14.3	16.2	5.5	2.1	3100	3450	0.97	72	45	208-250	4x14	5½
4GX - 5 HP	TBD		5	3.7	1.15	22.2	25.5	5.5	1.8	5000	3450	0.99	74	2x40	270-324	4x14	8¾

- V: Rated voltage
- P2: Rated output
- SF: Service factor
- In: Rated current
- In (SF): Service factor current
- Is/In: Locked rotor current/Rated current
- Cs/Cn: Locked rotor Torque/Rated Torque
- P1: Power consumption
- N: R.P.M
- Cos φ: Power factor
- η: Efficiency
- C: Capacitor
- Ø: Cable section
- LC: Cable length

4GX

SUBMERSIBLE MOTOR 4"

TECHNICAL DATA - THREE PHASE MOTORS

MODEL	3 WIRE	V [V]	P2		SF	In [A]	In (SF) [A]	Is/In	Cs/Cn	P1 [W]	N [min ⁻¹]	Cos φ	η %	C [μF]	CABLE	
	CODE		[HP]	[kW]											∅ [AWG]	LC [ft]
4GX - 1/2 HP	TBD	230	0.5	0.37	1.6	3.2	3.8	4.4	3.2	870	3450	0.4	42	-	4x14	5½
	TBD	460			1.6	1.6	1.9	5	3.2	870	3450	0.4	42	-	4x14	5½
	TBD	575			1.6	1.3	1.5	5	3.2	650	3450	0.54	57	-	4x14	5½
4GX - 3/4 HP	TBD	230	0.75	0.55	1.5	4.4	4.8	5.2	3.6	1140	3450	0.47	48	-	4x14	5½
	TBD	460			1.5	2.2	2.4	5.5	3.6	1140	3450	0.47	48	-	4x14	5½
	TBD	575			1.5	1.8	1.9	5.5	3.6	840	3450	0.48	65	-	4x14	5½
4GX - 1 HP	TBD	230	1	0.75	1.4	5.2	5.6	6.4	4.2	1260	3450	0.59	59	-	4x14	5½
	TBD	460			1.4	2.6	2.8	5.8	4.2	1260	3450	0.59	59	-	4x14	5½
	TBD	575			1.4	2.1	2.2	5.8	4.2	1200	3450	0.59	63	-	4x14	5½
4GX - 1 1/2 HP	60152125	230	1.5	1.1	1.3	7.2	7.8	5.9	4.1	1875	3450	0.53	60	-	4x14	5½
	TBD	460			1.25	3.6	3.9	6.7	4.1	1875	3450	0.53	60	-	4x14	5½
	TBD	575			1.3	2.9	3.1	6.7	4.1	1720	3450	0.60	64	-	4x14	5½
4GX - 2 HP	60177172	230	2	1.5	1.15	9.2	9.8	6.1	3.8	2230	3450	0.57	67	-	4x14	5½
	TBD	460			1.15	4.6	4.9	6.7	3.8	2230	3450	0.57	67	-	4x14	5½
	TBD	575			1.25	3.7	6.1	6.7	3.8	2160	3450	0.59	69	-	4x14	5½
4GX - 3 HP	TBD	230	3	2.2	1.15	11.2	12	7.5	4.8	3160	3450	0.69	71	-	4x14	5½
	TBD	460			1.15	5.6	6	7.1	4.8	3160	3450	0.69	71	-	4x14	5½
	TBD	575			1.15	4.5	4.8	7.1	4.8	3050	3450	0.68	72	-	4x14	5½
4GX - 5 HP	TBD	230	5	4	1.15	17.8	19.2	7.4	4	5230	3450	0.7	77	-	4x14	8¾
	TBD	460			1.15	8.9	9.6	7.4	4	5230	3450	0.7	77	-	4x14	8¾
	TBD	575			1.15	7.1	7.7	7.4	4.4	5300	3450	0.75	75	-	4x14	8¾
4GX - 7.5 HP	TBD	230	7.5	5.5	1.15	24	26	7.5	3.8	7100	3450	0.71	78	-	4x14	8¾
	TBD	460			1.15	12	13	7.5	3.8	7100	3450	0.71	78	-	4x14	8¾
	TBD	575			1.15	9.6	10.4	7.5	3.8	7050	3450	0.74	79	-	4x14	8¾
4GX - 10 HP	TBD	460	10	7.5	1.15	15.4	16.6	7.1	3.9	9300	3450	0.78	80	-	4x14	11½
	TBD	575			1.15	12.3	13.5	7.1	3.9	9100	3450	0.74	82	-	4x14	11½

P2: Rated output
V: Rated voltage
SF: Service factor
In: Rated current
In (SF): Service factor current

Is/In: Locked rotor current/Rated current
Cs/Cn: Locked rotor Torque/Rated Torque
P1: Power consumption
N: R.P.M
Cos φ: Power factor

η: Efficiency
C: Capacitor
∅: Cable section
LC: Cable length

4GX

SUBMERSIBLE MOTOR 4'

DIMENSIONS AND WEIGHTS - SINGLE PHASE MOTORS

MODEL	L LENGTH inch	WEIGHT lbs	AXIAL THRUST lbf	Q.TY x PALLET
4GX - 1/2 HP - 0.37kW	10.472	20.3	500	N/A
4GX - 3/4 HP - 0.55kW	11.26	22.3	500	N/A
4GX - 1 HP - 0.75kW	13.622	28.7	700	N/A
4GX - 1 1/2 HP - 1.1kW	16.181	33.3	700	N/A
4GX - 2 HP - 1.5kW	16.181	33.5	700	N/A
4GX - 3 HP - 2.2kW	21.417	39.7	1500	N/A
4GX - 5 HP - 3.7kW	26.929	60.3	1500	N/A

DIMENSIONS AND WEIGHTS - THREE PHASE MOTORS

MODEL	L LENGTH inch	WEIGHT lbs	AXIAL THRUST lbf	Q.TY x PALLET
4GX - 1/2 HP - 0.37kW	9.291	17.2	500	N/A
4GX - 3/4 HP - 0.55kW	10.472	20.3	500	N/A
4GX - 1 HP - 0.75kW	11.26	22.3	500	N/A
4GX - 1 1/2 HP - 1.1kW	13.622	26.7	700	N/A
4GX - 2 HP - 1.5kW	15.394	31.3	700	N/A
4GX - 3 HP - 2.2kW	19.843	33.3	1500	N/A
4GX - 5 HP - 3.7kW	24.173	52.3	1500	N/A
4GX - 7.5 HP - 5.5kW	26.929	60.3	1500	N/A
4GX - 10 HP - 7.5kW	30.079	69.1	1500	N/A

POS.	inch	POS.	inch	POS.	inch
A	0.610	D	1 1/2"	F	3"
B	0.591	E	1.465	G	3 3/8"
C	7/8"				

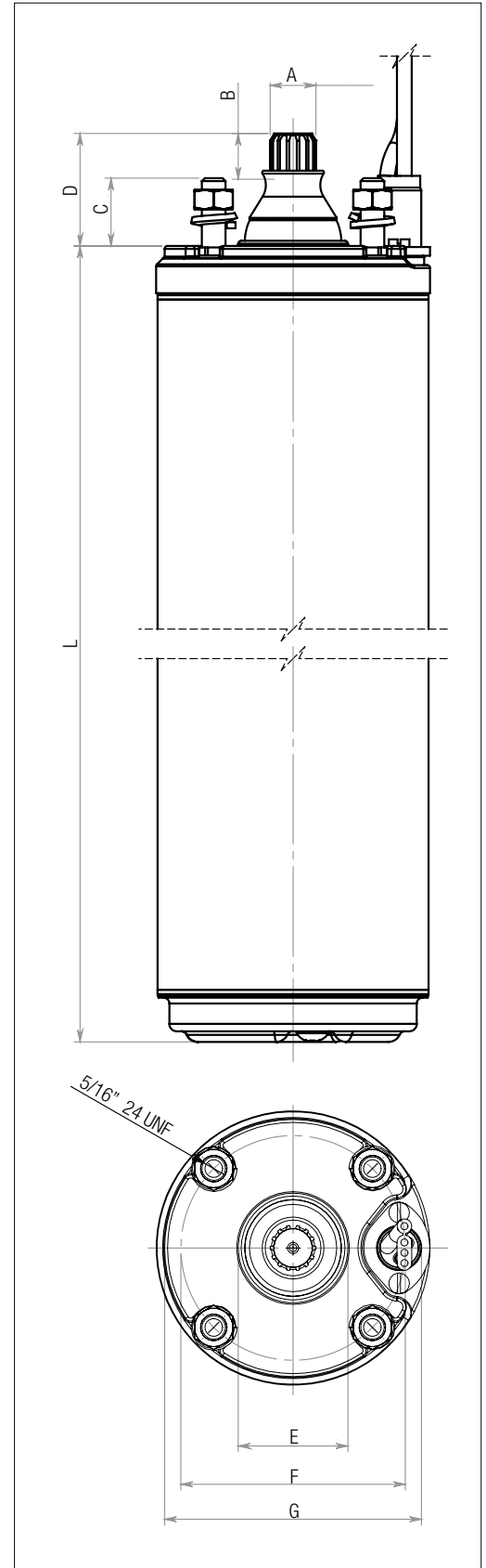

6GF

SUBMERSIBLE MOTOR 6"



6" Asynchronous two-poles submersible motor, made in AISI 304 stainless steel and cast iron with paint coating for parts in contact with water. Cooling and lubrication of the thrust bearing assembly and carbon bushes is provided by a mixture of water and glycol. Squirrel-cage rotor mounted on Kingsbury self-centring thrust bearing. Stator housed in an airtight stainless steel casing (canned-type). Removable cable connector to allow fast and easy maintenance. The cable is certified ACS, WRAS and KTW. Motor suitable for use with variable frequency drive (30 Hz-50/60 Hz). The motor is available in three-phase version with DOL or STAR-DELTA starting type. Overload protection must be provided by user. The motor can be equipped also with a PT100 temperature sensor.

- Flange** NEMA 6"
- Insulation class** F
- Degree of protection** IP68
- Cooling flow** 1.0 ft/sec @ 95 °F
- Voltage tolerance** + 6% / -10%
- Max starts** 25/h
- Max operating depth** 984 ft
- Horizontal operation** 5.5 HP - 60 HP



ACCESSORIES
PAG. 127

TECHNICAL DATA - SINGLE PHASE MOTORS

MODEL	3 WIRE	V [V]	P2		SF	In [A]	In (SF) [A]	Is/In	P1 [W]	N [min ⁻¹]	Cos φ	η %	C [μF]		Ø [AWG]	LC [ft]
	CODE		[HP]	[kW]									Start	Run		
6GF - 7.5 HP	60187218	230	7.5	5.5	1.15	33	37	15	7520	3490	0.72	74	486-584	45	4x10	13
6GF - 10 HP	60187219	230	10	7.5	1.15	43	49	20	9800	3490	0.76	77	616-740	70	4x10	13
6GF - 15 HP	60187220	230	15	11	1.15	63	74	30	14350	3490	0.77	76	701-841	135	4x8	13

TECHNICAL DATA - THREE PHASE MOTORS

MODEL	3 WIRE	V [V]	P2		SF	In [A]	In (SF) [A]	Is/In	P1 [W]	N [min ⁻¹]	Cos φ	η %	Start *	CABLE	
	CODE		[HP]	[kW]										Ø [AWG]	LC [ft]
6GF - HP 5.5	60181824	230	5.5	4	1.15	18.5	20	5.1	5700	3450	0.77	70	Δ	4x10	13
	60181833	460			1.15	8.6	9.5	5.5	5700	3470	0.83	70	Y	4x10	13
	TBD	575			1.15	6.9	7.6	5.5	5700	3470	0.83	70	Y	4x10	13
6GF - HP 7.5	60181825	230	7.5	5.5	1.15	24	26.6	5	7400	3480	0.77	74	Δ	4x10	13
	60181834	460			1.15	12	13.3	5	7400	3480	0.77	74	Y	4x10	13
	TBD	575			1.15	9.6	10.6	5.0	7400	3470	0.77	74	Y	4x10	13
6GF - HP 10	60181826	230	10	7.5	1.15	34	37	4.8	9900	3465	0.73	76	Δ	4x10	13
	60181835	460			1.15	15	16.5	5.5	9900	3465	0.83	76	Y	4x10	13
	TBD	575			1.15	12.0	13.2	5.5	9900	3465	0.83	76	Y	4x10	13
6GF - HP 15	60181828	230	15	11	1.15	50	54	4.4	13400	3495	0.67	82	Δ	4x10	13
	60181837	460			1.15	21	23.3	5.2	13400	3495	0.8	82	Y	4x10	13
	TBD	575			1.15	16.8	18.6	5.2	13400	3480	0.80	82	Y	4x10	13



6GF

SUBMERSIBLE MOTOR 6"

MODEL	3 WIRE	V [V]	P2		SF	In [A]	In (SF) [A]	Is/In	P1 [W]	N [min ⁻¹]	Cos φ	η %	Start *	CABLE	
	CODE		[HP]	[kW]										∅ [AWG]	LC [ft]
6GF - HP 20	60181830	230	20	15	1.15	63	68	4.8	18200	3475	0.73	82	Δ	4x10	13
	60181839	460			1.15	27.6	30.8	5.4	18200	3475	0.83	82	Y	4x10	13
	TBD	575			1.15	22.1	24.6	5.4	18200	3475	0.83	82	Y	4x10	13
6GF - HP 25	60181831	230	25	18.5	1.15	73.4	80	5.7	22200	3475	0.76	83	Δ	4x8	13
	60181840	460			1.15	36.7	40	5.7	22200	3475	0.76	83	Y	4x8	13
	TBD	575			1.15	29.3	33.2	5.7	22200	3475	0.76	83	Y	4x8	13
6GF - HP 30	60181832	230	30	22	1.15	95	105	5.5	26500	3480	0.7	83	Δ	4x8	13
	60181841	460			1.15	44.7	49.8	5.8	26500	3480	0.74	83	Y	4x8	13
	TBD	575			1.15	35.7	39.8	5.8	26500	3480	0.75	83	Y	4x8	13
6GF - HP 40	60181842	460	40	30	1.15	54	62	6.3	35700	3480	0.83	84	Y	4x8	13
	TBD	575			1.15	43.2	49.6	6.3	35700	3480	0.83	84	Y	4x8	13
6GF - HP 50	60181843	460	50	37	1.15	69	77	6.1	44800	3480	0.82	83	Y	4x8	13
	TBD	575			1.15	55.0	62.0	6.2	44800	3480	0.82	83	Y	4x8	13
6GF - HP 60	60181844	460	60	45	1.15	82	92	6.5	53500	3450	0.83	84	Y	4x8	13
	TBD	575			1.15	65.6	73.6	6.5	53500	3450	0.83	84	Y	4x8	13

* Star-delta version 230/380 V and 380/660 V available.

- P2: Rated output
- V: Rated voltage
- SF: Service factor
- In: Rated current
- In (SF): Service factor current
- Is/In: Locked rotor current/Rated current
- Cs/Cn: Locked rotor Torque/Rated Torque
- P1: Power consumption
- N: R.P.M
- Cos φ: Power factor
- η: Efficiency
- C: Capacitor
- ∅: Cable section
- LC: Cable length

6GF

SUBMERSIBLE MOTOR 6"

DIMENSIONS AND WEIGHTS - SINGLE PHASE MOTORS

MODEL	L LENGTH inch	WEIGHT lbs	AXIAL THRUST lbf	Q.TY x PALLET
6GF - 7.5 HP - 5.5kW	28.74	154.5	3600	N/A
6GF - 10 HP - 7.5kW	30.944	168	3600	N/A
6GF - 15 HP - 11kW	33.897	185.2	3600	N/A

DIMENSIONS AND WEIGHTS - THREE PHASE MOTORS

MODEL	L LENGTH inch	WEIGHT lbs	AXIAL THRUST lbf	Q.TY x PALLET
6GF - HP 5.5 - 4kW	23.661	123.3	3600	N/A
6GF - HP 7.5 - 5.5kW	24.843	130.7	3600	N/A
6GF - HP 10 - 7.5kW	26.023	137.4	3600	N/A
6GF - HP 15 - 11kW	28.779	162.1	3600	N/A
6GF - HP 20 - 15kW	30.944	174.8	3600	N/A
6GF - HP 25 - 18.5kW	33.897	192.1	3600	N/A
6GF - HP 30 - 22kW	36.258	205.3	3600	N/A
6GF - HP 40 - 30kW	41.377	236.6	6000	N/A
6GF - HP 50 - 37kW	46.496	274.5	6000	N/A
6GF - HP 60 - 45kW	53.582	311.5	6000	N/A

POS.	inch	POS.	inch
A	1.535	E	0.236
B	0.984	F	5.551
C	0.984	G	4.370
D	2.867	H	3.000

KIT CABLE CONNECTOR USA VERSION	DESCRIPTION	CODE
	KIT CABLE CONNECTOR - FT 13.12	SP00003221
	KIT CABLE CONNECTOR - FT 13.12	SP00003222

ON REQUEST

- CABLES WITH DIFFERENT LENGTH
- DIFFERENT SUPPLY VOLTAGES
- SINGLE PHASE VERSION (UP TO 15 HP)
- PT100 TEMPERATURE SENSOR
- PTC TEMPERATURE SENSOR (ONLY DOL VERSION)

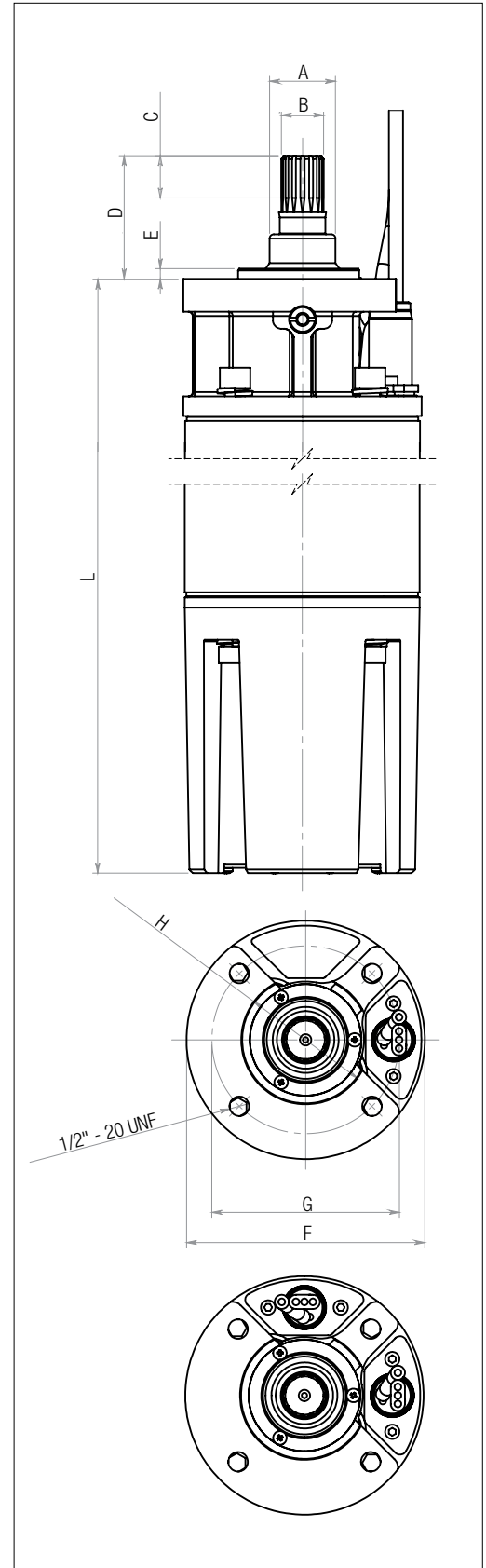

TR8

SUBMERSIBLE MOTOR 8"



8" Asynchronous two-poles or four-poles submersible motor, rewindable type, with external shell made in AISI 316 stainless steel and supports in cast iron with paint coating (standard version). Cooling and lubrication of the thrust bearing assembly and carbon bushes is provided by a mixture of water and glycol. Squirrel-cage rotor mounted on Mitchell self-centring thrust bearing. The motor is available also in full stainless steel **AISI 316** version or **AISI 904** version. On request it's available also a version suitable for use with variable frequency drive (30 Hz-50/60 Hz). The motor is equipped with 5 meters three-core cable directly connected with the windings and it's available with DOL or STAR-DELTA starting type. The cable is certified ACS and WRAS and KTW. Overload protection must be provided by user. On request PT100 and PTC temperature sensors.

Flange NEMA 8"

Degree of protection IP58 - (IP68) optional

Cooling flow 1.64 ft/sec

Voltage tolerance + 6% / -10%

Max starts 10/h

Max operating depth 984 ft

Max operating pressure 870 psi

Horizontal operation 30 HP - 125 HP



ACCESSORIES
PAG. 127

TECHNICAL DATA - THREE PHASE MOTORS - 2 POLES

DOL**

MODEL	STANDARD	AISI 316	V* [V]	P2		SF	In (SF) [A]	Is/In	P1 [W]	N [min ⁻¹]	Cos φ	η %	CABLE	
	CODE	CODE		[HP]	[kW]								∅ [AWG]	LC [ft]
TR840 - 30KW	60175454	60146759	460	40	30	1.15	61	5.8	41566	3490	0.85	83	3x4+ 1 x4	16
	TBD	TBD	575			1.15	49	5.8	41968	3005	0.86	83	3x4+ 1 x4	16
TR850 - 37KW	60175455	60146760	460	50	37	1.15	74	5.5	50655	3490	0.85	84	3x4+ 1 x4	16
	TBD	TBD	575			1.15	58	5.8	50337	3460	0.84	81	3x4+ 1 x4	16
TR860 - 45kW	60175456	60146761	460	60	45	1.15	88	6.4	60174	3500	0.85	86	3x4+ 1 x4	16
	TBD	TBD	575			1.15	68	6.5	59262	3500	0.82	87	3x4+ 1 x4	16
TR875 - 55KW	60175457	60146762	460	75	55	1.15	107	5.8	73547	3500	0.86	86	3x4+ 1 x4	16
	TBD	TBD	575			1.15	85	6.5	74621	3485	0.88	3485	3x4+ 1 x4	16
TR885 - 63KW	60175458	60146763	460	85	63	1.15	120	6.0	84244	3510	0.86	86	3x4+ 1 x4	16
	TBD	TBD	575			1.15	97	6.4	86105	3485	0.89	80	3x4+ 1 x4	16
TR8100 - 75KW	60175459	60146764	460	100	75	1.15	143	5.7	99138	3500	0.86	87	3x4+ 1 x4	16
	TBD	TBD	575			1.15	112	5.8	99274	3470	0.89	86	3x4+ 1 x4	16
TR8125 - 92KW	60175460	60146765	460	125	92	1.15	175	6.0	121609	3480	0.87	87	3x4+ 1 x4	16
	TBD	TBD	575			1.15	133	5.6	118183	3460	0.89	83	3x4+ 1 x4	16
TR8150 - 110KW	60175461	60146767	460	150	110	1.15	210	5.8	147093	3480	0.87	86	3x4+ 1 x4	16
	TBD	TBD	575			1.15	167	5.7	144699	3490	0.87	86	3x4+ 1 x4	16

P2: Rated output
V: Rated voltage
SF: Service factor
In: Rated current
In (SF): Service factor current

Is/In: Locked rotor current/Rated current
Cs/Cn: Locked rotor Torque/Rated Torque
P1: Power consumption
N: R.P.M
Cos φ: Power factor

η: Efficiency
C: Capacitor
∅: Cable section
LC: Cable length

* Available on request Voltage up to 1000 V

** Available on request STAR/DELTA version



TR8

SUBMERSIBLE MOTOR 8"

TECHNICAL DATA - THREE PHASE MOTORS - 4 POLES

DOL**

MODEL	STANDARD	AISI 316	V* [V]	P2		SF	In (SF) [A]	Is/In	P1 [W]	N [min ⁻¹]	Cos φ	η %	Ø [AWG]	LC [ft]
	CODE	CODE		[HP]	[kW]									
TR815 - 11kW	60175462	60161133	460	15	11	1.15	25	5.0	15427	1750	0.78	82	3x4+ 1 x4	16
	TBD	TBD	575			1.15	20.4	5.0	16050	1755	0.79	80	3x4+ 1 x4	16
TR820 - 15kW	60175463	60161134	460	20	15	1.15	34	4.9	20783	1750	0.79	83	3x4+ 1 x4	16
	TBD	TBD	575			1.15	26.6	4.9	21756	1745	0.82	81	3x4+ 1 x4	16
TR825 - 18.5kW	60175464	60161135	460	25	18.5	1.15	40	4.7	25327	1750	0.82	84	3x4+ 1 x4	16
	TBD	TBD	575			1.15	32.8	4.7	26787	1745	0.82	81	3x4+ 1 x4	16
TR830 - 22kW	60175465	60161136	460	30	22	1.15	47	4.7	30119	1750	0.81	84	3x4+ 1 x4	16
	TBD	TBD	575			1.15	39.1	4.7	31558	1745	0.81	81	3x4+ 1 x4	16
TR835 - 26kW	60175466	60161137	460	35	26	1.15	56	4.7	36024	1750	0.82	83	3x4+ 1 x4	16
	TBD	TBD	575			1.15	45.8	4.7	36979	1750	0.77	0.81	3x4+ 1 x4	16
TR840 - 30kW	60175467	60161138	460	40	30	1.15	63	4.5	41071	1750	0.84	84	3x4+ 1 x4	16
	TBD	TBD	575			1.15	51.5	4.4	42588	1740	0.83	82	3x4+ 1 x4	16
TR850 - 37kW	60175468	60161139	460	50	37	1.15	78	4.5	50655	1750	0.83	84	3x4+ 1 x4	16
	TBD	TBD	575			1.15	63.7	4.5	52005	1755	0.82	84	3x4+ 1 x4	16
TR860 - 45kW	60175469	60161140	460	60	45	1.15	88	6.4	60174	1735	0.85	86	3x4+ 1 x4	16
	TBD	TBD	575			1.15	75.8	4.8	62625	1735	0.83	84	3x4+ 1 x4	16

P2: Rated output
 V: Rated voltage
 SF: Service factor
 In: Rated current
 In (SF): Service factor current
 Is/In: Locked rotor current/Rated current
 Cs/Cn: Locked rotor Torque/Rated Torque
 P1: Power consumption
 N: R.P.M
 Cos φ: Power factor
 η: Efficiency
 C: Capacitor
 Ø: Cable section
 LC: Cable length

* Available on request Voltage up to 1000 V
 ** Available on request STAR/DELTA version

TR8

SUBMERSIBLE MOTOR 8"

DIMENSIONS AND WEIGHTS - THREE PHASE MOTORS - 2 POLES

MODEL	L LENGTH inch	WEIGHT lbs	AXIAL THRUST lbf
TR840 - 30KW	44	322	13500
TR850 - 37KW	46	344	13500
TR860 - 45kW	50	390	13500
TR875 - 55KW	53	423	13500
TR885 - 63KW	59	481	13500
TR8100 - 75KW	63	522	13500
TR8125 - 92KW	72	624	13500
TR8150 - 110KW	81	734	13500

DIMENSIONS AND WEIGHTS - THREE PHASE MOTORS - 4 POLES

MODEL	L LENGTH inch	WEIGHT lbs	AXIAL THRUST lbf
TR815 - 11kW	44	322	13500
TR820 - 15kW	46	344	13500
TR825 - 18.5kW	50	390	13500
TR830 - 22kW	53	423	13500
TR835 - 26kW	59	481	13500
TR840 - 30kW	63	522	13500
TR850 - 37kW	72	624	13500
TR860 - 45kW	72	624	13500

POS.	inch	POS.	inch	POS.	inch
A	7.559	E	3.740	I	4 x 0.709"
B	5"	F	5.906	J	2.677
C	1 1/2"	G	7.283	K	6.004
D	4"	H	9.567		

ON REQUEST

- CABLES WITH DIFFERENT LENGTH
- DIFFERENT SUPPLY VOLTAGES
- PT100 TEMPERATURE SENSOR
- PTC TEMPERATURE SENSOR
- SPECIAL TERMINAL SHAFT
- DEGREE OF PROTECTION IP 68

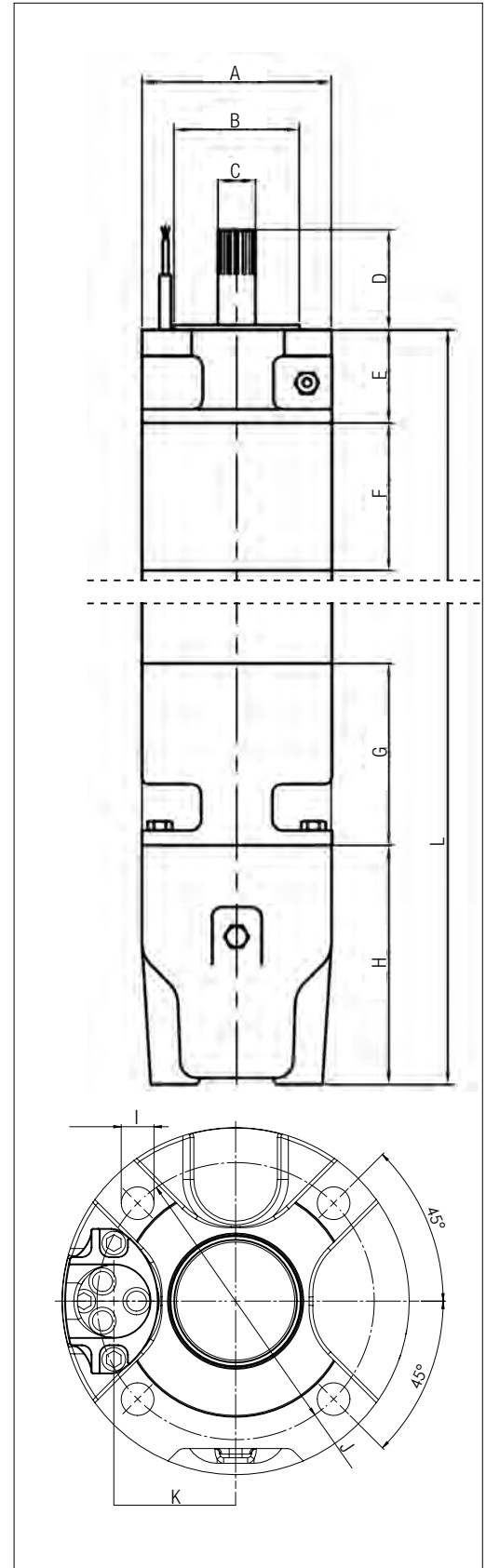

TR10

SUBMERSIBLE MOTOR 10"



10" Asynchronous two-poles or four-poles submersible motor, rewindable type, with external shell made in AISI 316 stainless steel and supports in cast iron with paint coating (standard version). Cooling and lubrication of the thrust bearing assembly and carbon bushes is provided by a mixture of water and glycol. Squirrel-cage rotor mounted on Mitchell self-centring thrust bearing. The motor is available also in full stainless steel **AISI 316** version or **AISI 904** version.

On request it's available also a version suitable for use with variable frequency drive (30 Hz-50/60 Hz). The motor is equipped with 8 meters single-core cables directly connected with the windings and it's available with DOL or STAR-DELTA starting type.

The cables are certified ACS and WRAS and KTW. Overload protection must be provided by user.

On request PT100 and PTC temperature sensors are available.

Flange NEMA 10"

Degree of protection IP58 - (IP68) optional

Cooling flow 1.64 ft/sec

Voltage tolerance + 6% / -10%

Max starts 8/h

Max operating depth 984 ft

Max operating pressure 870 psi

Horizontal operation 100 HP - 230 HP



ACCESSORIES
PAG. 127

TECHNICAL DATA - THREE PHASE MOTORS - 2 POLES

DOL**

MODEL	STANDARD	AISI 316	V* [V]	P2		SF	In (SF) [A]	Is/In	P1 [W]	N [min ⁻¹]	Cos φ	η %	Ø [AWG]	LC [ft]
	CODE	CODE		[HP]	[kW]									
TR10100 - 75KW	60146838	60146852	460	100	75	1.15	146	5.7	99138	3510	0.84	87	3x0+1x3	26
	TBD	TBD				1.15	121	5.4	102431	3485	0.85	85	3x0+1x3	26
TR10125 - 92KW	60146839	60146853	460	125	92	1.15	181	5.5	121609	3510	0.83	87	3x0+1x3	26
	TBD	TBD				1.15	148	5.6	125288	3485	0.85	85	3x0+1x3	26
TR10150 - 110KW	60146840	60146854	460	150	110	1.15	213	5.8	143750	3510	0.84	88	3x0+1x3	26
	TBD	TBD				1.15	172	5.7	147318	3495	0.86	86	3x0+1x3	26
TR10180 - 132KW	60146841	60146855	460	180	132	1.15	252	5.7	172500	3510	0.85	88	3x0+1x3	26
	TBD	TBD				1.15	190	5.7	168834	3485	0.89	90	3x0+1x3	26
TR10200 - 147KW	60146842	60146856	460	200	147	1.15	290	6.2	194310	3520	0.82	87	3x0+1x3	26
	TBD	TBD				1.15	229	6.2	198419	3500	0.87	85	3x0+1x3	26
TR10230 - 170KW	60146843	60146857	460	230	170	1.15	338	5.9	224713	3520	0.82	87	3x0+1x3	26
	TBD	TBD				1.15	271	6	226713	3515	0.84	86	3x0+1x3	26
TR10260 - 190KW	60146844	60146858	460	260	190	1.15	386	6.1	251149	3520	0.79	87	3x0+1x3	26
	TBD	TBD				1.15	286	5.9	247559	3500	0.87	84	3x0+1x3	26

P2: Rated output
V: Rated voltage
SF: Service factor
In: Rated current
In (SF): Service factor current

Is/In: Locked rotor current/Rated current
Cs/Cn: Locked rotor Torque/Rated Torque
P1: Power consumption
N: R.P.M
Cos φ: Power factor

η: Efficiency
C: Capacitor
Ø: Cable section
LC: Cable length

* Available on request Voltage up to 1000 V
** Available on request STAR/DELTA version

TR10

SUBMERSIBLE MOTOR 10"

TECHNICAL DATA - THREE PHASE MOTORS - 4 POLES

DOL**

MODEL	STANDARD	AISI 316	V* [V]	P2		SF	In (SF) [A]	Is/In	P1 [W]	N [min ⁻¹]	Cos φ	η %	Ø [AWG]	LC [ft]
	CODE	CODE		[HP]	[kW]									
TR1040 - 30KW	60161141	60161148	460	40	30	1.15	62	5.3	40116	1750	0.82	86	3x0+1x3	26
	TBD	TBD	575			1.15	49.6	5.3	40012	1755	0.81	86	3x0+1x3	26
TR1050 - 37KW	60161142	60161149	460	50	37	1.15	73	5.5	48908	1750	0.86	87	3x0+1x3	26
	TBD	TBD	575			1.15	61.6	5.5	49079	1760	0.81	87	3x0+1x3	26
TR1060 - 45KW	60161143	60161150	460	60	45	1.15	89	4.6	58807	1750	0.83	88	3x0+1x3	26
	TBD	TBD	575			1.15	72.4	4.6	59847	1750	0.83	86	3x0+1x3	26
TR1075 - 55KW	60161144	60161152	460	75	55	1.15	109	5.3	71875	1750	0.84	88	3x0+1x3	26
	TBD	TBD	575			1.15	88	5.3	71866	1755	0.82	88	3x0+1x3	26
TR10100 - 75KW	60161145	60161153	460	100	75	1.15	147	5.4	98011	1750	0.83	88	3x0+1x3	26
	TBD	TBD	575			1.15	119	5.4	97346	1755	0.82	88	3x0+1x3	26
TR10125 - 90KW	60161146	60161154	460	125	90	1.15	183	5.3	117614	1750	0.84	88	3x0+1x3	26
	TBD	TBD	575			1.15	145	5.3	121137	1750	0.84	87	3x0+1x3	26
TR10150 - 110KW	60161147	60161155	460	150	110	1.15	217	5.6	145230	1750	0.84	87	3x0+1x3	26
	TBD	TBD	575			1.15	174	5.6	145230	1745	0.84	87	3x0+1x3	26

P2: Rated output
 V: Rated voltage
 SF: Service factor
 In: Rated current
 In (SF): Service factor current
 Is/In: Locked rotor current/Rated current
 Cs/Cn: Locked rotor Torque/Rated Torque
 P1: Power consumption
 N: R.P.M
 Cos φ: Power factor
 η: Efficiency
 C: Capacitor
 Ø: Cable section
 LC: Cable length

* Available on request Voltage up to 1000 V
 ** Available on request STAR/DELTA version

TR10

SUBMERSIBLE MOTOR 10"

DIMENSIONS AND WEIGHTS - THREE PHASE MOTORS - 2 POLES

MODEL	L LENGTH inch	WEIGHT lbs	AXIAL THRUST lbf
TR10100 - 75KW	55	617	13500
TR10125 - 92KW	59	728	13500
TR10150 - 110KW	67	849	13500
TR10180 - 132KW	74	959	13500
TR10200 - 147KW	81	1102	13500
TR10230 - 170KW	87	1190	13500
TR10260 - 190KW	94	1279	13500

DIMENSIONS AND WEIGHTS - THREE PHASE MOTORS - 4 POLES

MODEL	L LENGTH inch	WEIGHT lbs	AXIAL THRUST lbf
TR1040 - 30KW	50	551	13500
TR1050 - 37KW	55	617	13500
TR1060 - 45KW	59	728	13500
TR1075 - 55KW	67	849	13500
TR10100 - 75KW	74	959	13500
TR10125 - 90KW	81	1102	13500
TR10150 - 110KW	81	1200	13500

POS.	inch	POS.	inch	POS.	inch
A	9.134	G	8.268	N	3.071
B	5"	H	10.315	O	3.740
C	1.687	I	0.197	P	0.375
D	4"	J	7 1/2"	Q	1.874
E	4.528	K	4 x 0.827"		
F	7.874	M	1.693		

ON REQUEST

- CABLES WITH DIFFERENT LENGTH
- DIFFERENT SUPPLY VOLTAGES
- PT100 TEMPERATURE SENSOR
- PTC TEMPERATURE SENSOR
- SPECIAL TERMINAL SHAFT
- DEGREE OF PROTECTION IP 68

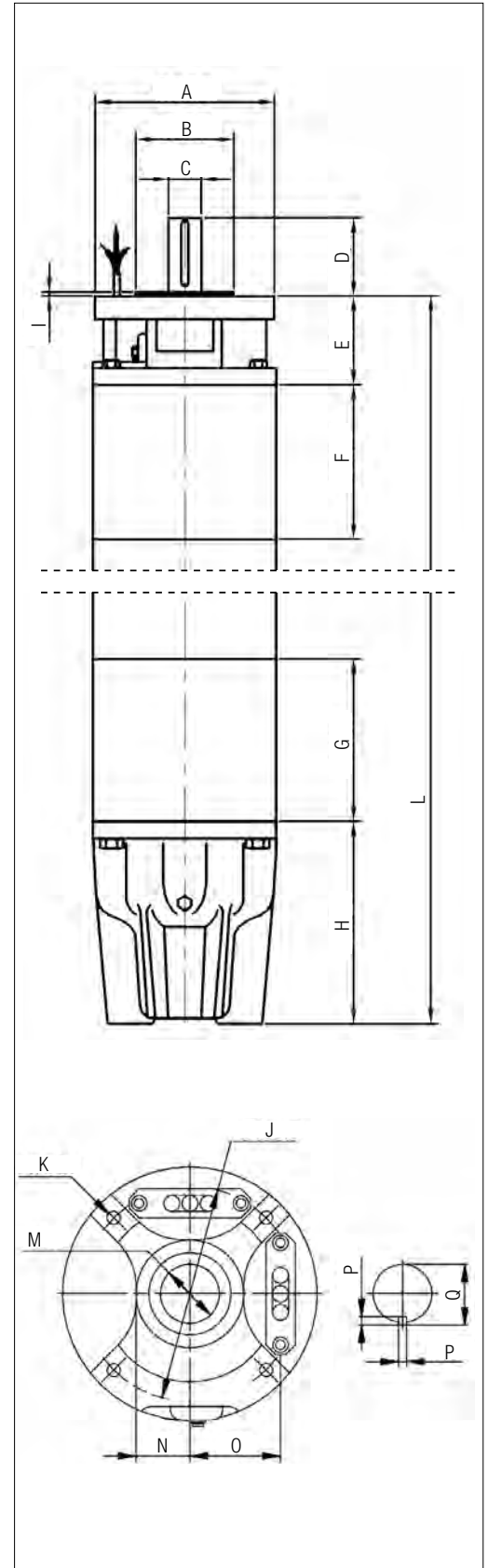

TR12

SUBMERSIBLE MOTOR 12"



12" Asynchronous two-poles or four-poles submersible motor, rewindable type, with external shell made in AISI 316 stainless steel and supports in cast iron with paint coating (standard version).

Cooling and lubrication of the thrust bearing assembly and carbon bushes is provided by a mixture of water and glycol. Squirrel-cage rotor mounted on Mitchell self-centring thrust bearing.

The motor is available also in full stainless steel **AISI 316** version and **AISI 904** version.

On request it's available also a version suitable for use with variable frequency drive (30 Hz-50/60 Hz). The motor is equipped with 8 meters single-core cables directly connected with the windings and it's available with DOL or STAR-DELTA starting type. The cables are certified ACS and WRAS and KTW. Overload protection must be provided by user.

On request PT100 and PTC temperature sensors are available.

Flange 12"

Degree of protection IP58 - (IP68) optional

Cooling flow 1.64 ft/sec)

Voltage tolerance + 6% / -10%

Max starts 5/h

Max operating depth 984 ft

Max operating pressure 870 psi

Horizontal operation 200 HP - 260 HP



ACCESSORIES
PAG. 127

TECHNICAL DATA - THREE PHASE MOTORS - 2 POLES

DOL**

MODEL	STANDARD	AISI 316	V* [V]	P2		SF	In (SF) [A]	Is/In	P1 [W]	N [min ⁻¹]	Cos φ	η %	Ø [AWG]	LC [ft]
	CODE	CODE		[HP]	[kW]									
TR12180 - 132KW	60175573	60175595	460	180	132	1.15	267	5.7	178694	3530	0.84	86	3x00+1x0	26
	TBD	TBD				1.15	211	5.7	178620	3510	0.85	86	3x00+1x0	26
TR12200 - 147KW	60175574	60175596	460	200	147	1.15	311	5.7	168966	3530	0.83	87	3x00+1x0	26
	TBD	TBD				1.15	238	5.9	199106	3520	0.84	86	3x00+1x0	26
TR12230 - 170KW	60175575	60175597	460	230	170	1.15	355	5.8	195402	3530	0.84	87	3x00+1x0	26
	TBD	TBD				1.15	271	5.8	232111	3515	0.86	85	3x00+1x0	26
TR12260 - 190KW	60175576	60175598	460	260	190	1.15	394	6.1	218391	3525	0.84	87	3x00+1x0	26
	TBD	TBD				1.15	297	5.8	257338	3505	0.87	86	3x00+1x0	26
TR12300 - 220KW	60175577	60175599	460	300	220	1.15	452	6.4	250000	3525	0.85	88	3x00+1x0	26
	TBD	TBD				1.15	340	5.8	294596	3005	0.87	86	3x00+1x0	26
TR12340 - 250KW	60175578	60175600	460	340	250	1.15	510	6.8	284091	3525	0.85	88	3x00+1x0	26
	TBD	TBD				1.15	388	5.7	336186	3515	0.87	87	3x00+1x0	26

P2: Rated output
V: Rated voltage
SF: Service factor
In: Rated current
In (SF): Service factor current

Is/In: Locked rotor current/Rated current
Cs/Cn: Locked rotor Torque/Rated Torque
P1: Power consumption
N: R.P.M
Cos φ: Power factor

η: Efficiency
C: Capacitor
Ø: Cable section
LC: Cable length

* Available on request Voltage up to 1000 V
** Available on request STAR/DELTA version

TR12

SUBMERSIBLE MOTOR 12"

TECHNICAL DATA - THREE PHASE MOTORS - 4 POLES

DOL**

MODEL	STANDARD	AISI 316	V* [V]	P2		SF	In (SF) [A]	Is/In	P1 [W]	N [min ⁻¹]	Cos φ	η %	Ø [AWG]	LC [ft]
	CODE	CODE		[HP]	[kW]									
TR12100 - 75KW	60161156	60161162	460	100	75	1.15	145	6.5	96910	1750	0.86	89	3x00+1x0	26
	TBD	TBD	575			1.15	115	6.5	98669	1755	0.86	87	3x00+1x0	26
TR12125 - 92KW	60161157	60161163	460	125	92	1.15	180	6.5	118876	1750	0.87	89	3x00+1x0	26
	TBD	TBD	575			1.15	146	6.5	120356	1765	0.83	88	3x00+1x0	26
TR12150 - 110KW	60161158	60161164	460	150	110	1.15	211	5.8	142135	1750	0.88	89	3x00+1x0	26
	TBD	TBD	575			1.15	170	5.8	144250	1760	0.85	87	3x00+1x0	26
TR12180 - 132KW	60161159	60161165	460	180	132	1.15	252	5.8	170562	1750	0.88	89	3x00+1x0	26
	TBD	TBD	575			1.15	202	6.2	171340	1760	0.85	88	3x00+1x0	26
TR12200 - 147KW	60161160	60161166	460	200	147	1.15	281	5.9	189944	1750	0.88	89	3x00+1x0	26
	TBD	TBD	575			1.15	221	5.9	191314	1750	0.87	87	3x00+1x0	26

P2: Rated output
 V: Rated voltage
 SF: Service factor
 In: Rated current
 In (SF): Service factor current
 Is/In: Locked rotor current/Rated current
 Cs/Cn: Locked rotor Torque/Rated Torque
 P1: Power consumption
 N: R.P.M
 Cos φ: Power factor
 η: Efficiency
 C: Capacitor
 Ø: Cable section
 LC: Cable length

* Available on request Voltage up to 1000 V

** Available on request STAR/DELTA version

TR12

SUBMERSIBLE MOTOR 12"

DIMENSIONS AND WEIGHTS - THREE PHASE MOTORS - 2 POLES

MODEL	L LENGTH inch	WEIGHT lbs	AXIAL THRUST lbf
TR12180 - 132KW	66	1135	16000
TR12200 - 147KW	70	1246	16000
TR12230 - 170KW	74	1334	16000
TR12260 - 190KW	78	1433	16000
TR12300 - 220KW	83	1543	16000
TR12340 - 250KW	90	1709	16000

DIMENSIONS AND WEIGHTS - THREE PHASE MOTORS - 4 POLES

MODEL	L LENGTH inch	WEIGHT lbs	AXIAL THRUST lbf
TR12100 - 75KW	65	1135	16000
TR12125 - 92KW	70	1246	16000
TR12150 - 110KW	74	1334	16000
TR12180 - 132KW	83	1543	16000
TR12200 - 147KW	87	1653	16000

POS.	inch	POS.	inch	POS.	inch
A	9.055	G	10.039	O	5/8"
B	5"	H	0.197	P	2.323
C	2.165	I	5"	Q	0.394
D	3.543	J	11.260		
E	6 1/2"	K	0.827		
F	4.331	M	7 1/2"		

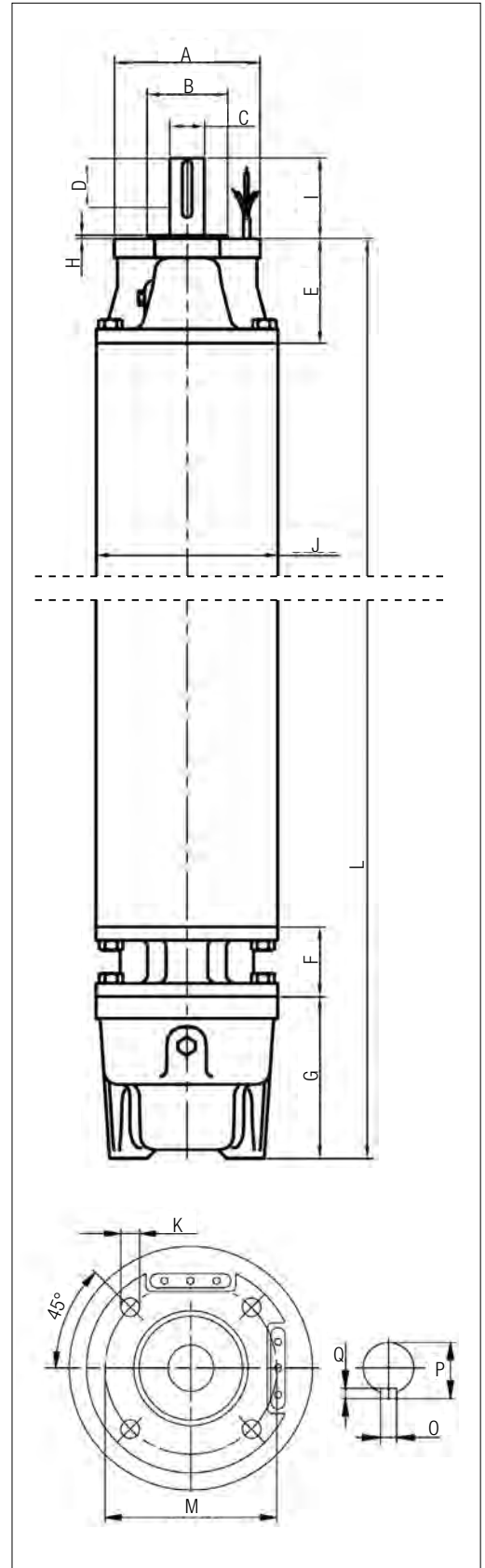

ON REQUEST

- CABLES WITH DIFFERENT LENGTH
- DIFFERENT SUPPLY VOLTAGES
- PT100 TEMPERATURE SENSOR
- PTC TEMPERATURE SENSOR
- SPECIAL TERMINAL SHAFT

TR14

SUBMERSIBLE MOTOR 14"



14" Asynchronous two-poles or four-poles submersible motor, rewindable type, with external shell made in AISI 316 stainless steel and supports in cast iron with paint coating (standard version).

Cooling and lubrication of the thrust bearing assembly and carbon bushes is provided by a mixture of water and glycol. Squirrel-cage rotor mounted on Mitchell self-centring thrust bearing. The motor is available also in full stainless steel AISI 316.

On request it's available also a version suitable for use with variable frequency drive (30 Hz-50/60 Hz). The motor is equipped with 8 meters single-core cables directly connected with the windings and it's available with DOL or STAR-DELTA starting type. The cables are certified ACS and WRAS and KTW. Overload protection must be provided by user.

On request PT100 and PTC temperature sensors are available.

Flange 14"

Degree of protection IP58 - (IP68) optional

Cooling flow 1.64 ft/sec

Voltage tolerance + 6% / -10%

Max starts PVC: 3/h - PE2+PA: 5/H

Max operating depth 984 ft

Max operating pressure 870 psi

Horizontal operation 300 HP - 340 HP



ACCESSORIES
PAG. 127

TECHNICAL DATA - THREE PHASE MOTORS - 2 POLES

S/D**

MODEL	STANDARD	AISI 316	V* [V]	P2		SF	In (SF) [A]	Is/In	P1 [W]	N [min ⁻¹]	Cos φ	η %	Ø [AWG]	LC [ft]
	CODE	CODE		[HP]	[kW]									
TR14300 - 220KW	TBD	TBD	460	300	220	1.15	460	5.5	290000	3530	0.79	89	6x00+1x0	26
	TBD	TBD	575			1.15	370	5.5	298803	3525	0.81	89	6x00+1x0	26
TR14340 - 250KW	TBD	TBD	460	340	250	1.15	505	6.0	326000	3545	0.81	89	6x00+1x0	26
	TBD	TBD	575			1.15	404	6.0	337979	3535	0.84	89	6x00+1x0	26
TR14400 - 300KW	TBD	TBD	460	400	300	1.15	595	6.0	389000	3540	0.82	89	6x00+1x0	26
	TBD	TBD	575			1.15	479	5.8	400889	3535	0.84	89	6x00+1x0	26
TR14450 - 330KW	TBD	TBD	460	450	330	1.15	645	6.0	427000	3545	0.83	90	6x00+1x0	26
	TBD	TBD	575			1.15	512	6.0	423230	3540	0.83	89	6x00+1x0	26
TR14500 - 370KW	TBD	TBD	460	500	370	1.15	725	6.5	480000	3550	0.83	90	6x00+1x0	26
	TBD	TBD	575			1.15	581	6.4	474317	3545	0.82	89	6x00+1x0	26
TR14550 - 400KW	TBD	TBD	460	550	400	1.15	750	6.5	520000	3540	0.87	90	6x00+1x0	26
	TBD	TBD	575			1.15	598	6.8	517796	3535	0.87	90	6x00+1x0	26

P2: Rated output
V: Rated voltage
SF: Service factor
In: Rated current
In (SF): Service factor current

Is/In: Locked rotor current/Rated current
Cs/Cn: Locked rotor Torque/Rated Torque
P1: Power consumption
N: R.P.M
Cos φ: Power factor

η: Efficiency
C: Capacitor
Ø: Cable section
LC: Cable length

* Available on request Voltage up to 1000 V
** Available on request STAR/DELTA version

TR14

SUBMERSIBLE MOTOR 14"

TECHNICAL DATA - THREE PHASE MOTORS - 4 POLES

S/D**

MODEL	STANDARD	AISI 316	V* [V]	P2		SF	In (SF) [A]	Is/In	P1 [W]	N [min ⁻¹]	Cos φ	η %	Ø [AWG]	LC [ft]
	CODE	CODE		[hp]	[kW]									
TR14230 - 170KW	60161167	TBD	460	230	170	1.15	352	5.5	228000	1750	0.81	86	6x00+1x0	26
	TBD	TBD	575			1.15	276	4.0	219901	1755	0.8	89	6x00+1x0	26
TR14260 - 190KW	60161168	TBD	460	260	190	1.15	384	6.0	252000	1750	0.82	87	6x00+1x0	26
	TBD	TBD	575			1.15	306	4.2	246528	1755	0.81	89	6x00+1x0	26
TR14300 - 220KW	60161169	TBD	460	300	220	1.15	440	6.0	291000	1750	0.83	87	6x00+1x0	26
	TBD	TBD	575			1.15	350	4.1	285505	1755	0.82	89	6x00+1x0	26
TR14350 - 260KW	60161170	TBD	460	350	260	1.15	514	6.0	340000	1750	0.83	88	6x00+1x0	26
	TBD	TBD	575			1.15	408	4.0	333198	1755	0.82	90	6x00+1x0	26
TR14400 - 300KW	60161171	TBD	460	400	300	1.15	607	6.5	393000	1750	0.81	88	6x00+1x0	26
	TBD	TBD	575			1.15	466	3.8	385206	1750	0.83	89	6x00+1x0	26

P2: Rated output
V: Rated voltage
SF: Service factor
In: Rated current
In (SF): Service factor current

Is/In: Locked rotor current/Rated current
Cs/Cn: Locked rotor Torque/Rated Torque
P1: Power consumption
N: R.P.M
Cos φ: Power factor

η: Efficiency
C: Capacitor
Ø: Cable section
LC: Cable length

* Available on request Voltage up to 1000 V

** Available on request STAR/DELTA version

TR14

SUBMERSIBLE MOTOR 14"

DIMENSIONS AND WEIGHTS - THREE PHASE MOTORS - 2 POLES

MODEL	L LENGTH inch	WEIGHT lbs	AXIAL THRUST lbf
TR14300 - 220KW	69	1462	16000
TR14340 - 250KW	75	1728	16000
TR14400 - 300KW	80	1863	16000
TR14450 - 330KW	85	1997	16000
TR14500 - 370KW	91	2227	16000
TR14550 - 400KW	97	2436	16000

DIMENSIONS AND WEIGHTS - THREE PHASE MOTORS - 4 POLES

MODEL	L LENGTH inch	WEIGHT lbs	AXIAL THRUST lbf
TR14230 - 170KW	75	1135	16000
TR14260 - 190KW	80	1246	16000
TR14300 - 220KW	85	1334	16000
TR14350 - 260KW	91	1543	16000
TR14400 - 300KW	97	1653	16000

POS.	inch	POS.	inch	POS.	inch
A	11.417	G	0.276	N	4.921
B	7.874	H	0.866	O	5/8 "
C	2.165	I	5 "	P	2.323
D	3.799	J	13.307	Q	0.394
E	3.937	K	3.228		
F	0.157	M	10.039		

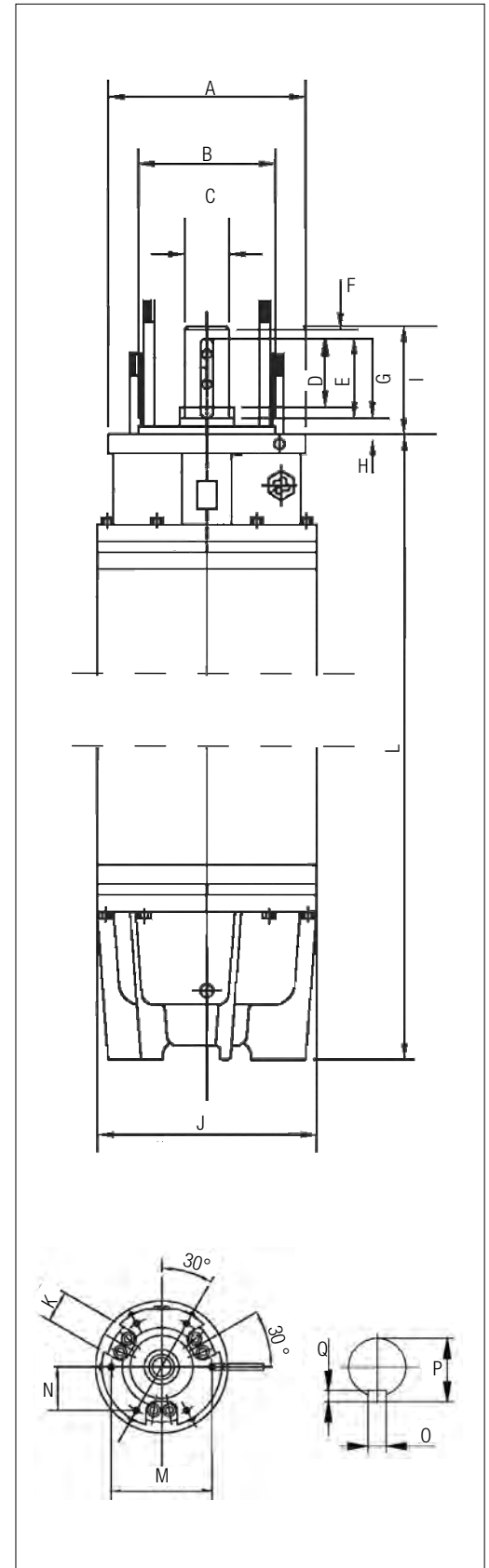

ON REQUEST

- CABLES WITH DIFFERENT LENGTH
- DIFFERENT SUPPLY VOLTAGES
- PT100 TEMPERATURE SENSOR
- PTC TEMPERATURE SENSOR
- SPECIAL TERMINAL SHAFT

DIVER 6

SUBMERSIBLE MULTI-IMPELLER PUMPS



6" multi-impeller submersible pump for clean water, designed for pressurization, rainwater re-use, gardening and irrigation in residential building service.

The pump is ideal for use in rainwater recovery systems and to increase the water pressure.

Available as manual or automatic model. The automatic version is a single-phase pump with a float switch for protection against dry running with the need for a control panel. The pump has an in built starting capacitor and the motor has integrated overheating protection.

Equipped with stainless steel debris filter, a non-return valve and a 49 ft power cable with power plug. Renewed to further increase reliability and the ergonomics (the handle has been completely redesigned).

The pumps is supplied as standard with a four-section step fitting and a 1" M/F check valve.

Flow rate maximum from 4.4 to 23.8 GPM

Head up to 151 ft

Maximum immersion depth 39 ft

Type of pumped liquid clean, free from solid or abrasive substances, non-viscous, non-aggressive, non-crystallized and chemically neutral

Minimum and maximum ambient temperature 32°F to 95°F

Maximum number of starts 20/h

Impeller/s material technopolymer

Power cable with plug 49 ft

Possible type of installation fixed or portable in vertical position

Special versions on request cables of different lengths, different plug

TECHNICAL DATA

MODEL	CODE	ELECTRICAL DATA						
		VOLTAGE 60 Hz	P1 MAX kW	P2 NOMINAL		In A	CAPACITOR	
				kW	HP		μF	Vc
DIVER 6 600 M-A	60193029.	115V/60Hz	0.95	0.65	0.88	8.7	30	250
DIVER 6 700 M-A	60193030.	115V/60Hz	0.77	0.55	0.75	7.8	30	250
DIVER 6 800 M-A	60193031.	115V/60Hz	0.95	0.65	0.9	8.7	30	250

RANGE PERFORMANCE

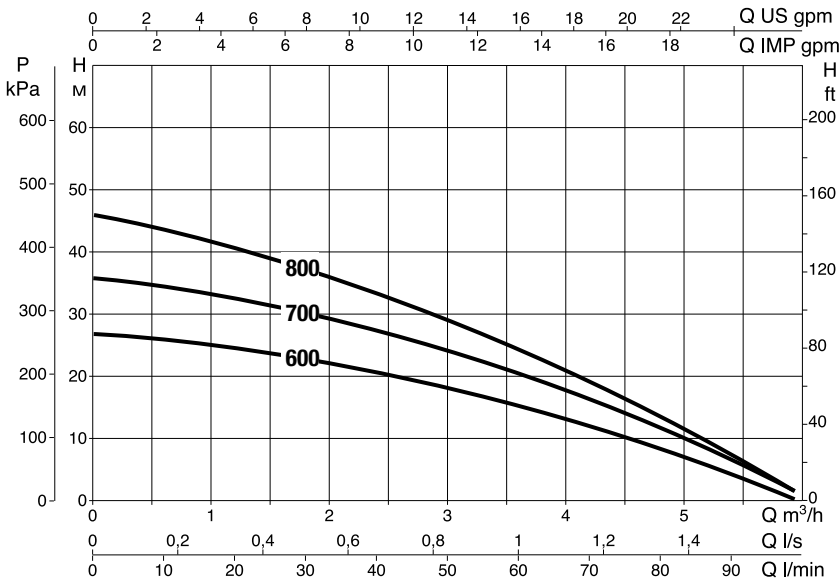

DIVER 6

SUBMERSIBLE MULTI-IMPELLER PUMPS

DIMENSIONS AND WEIGHTS

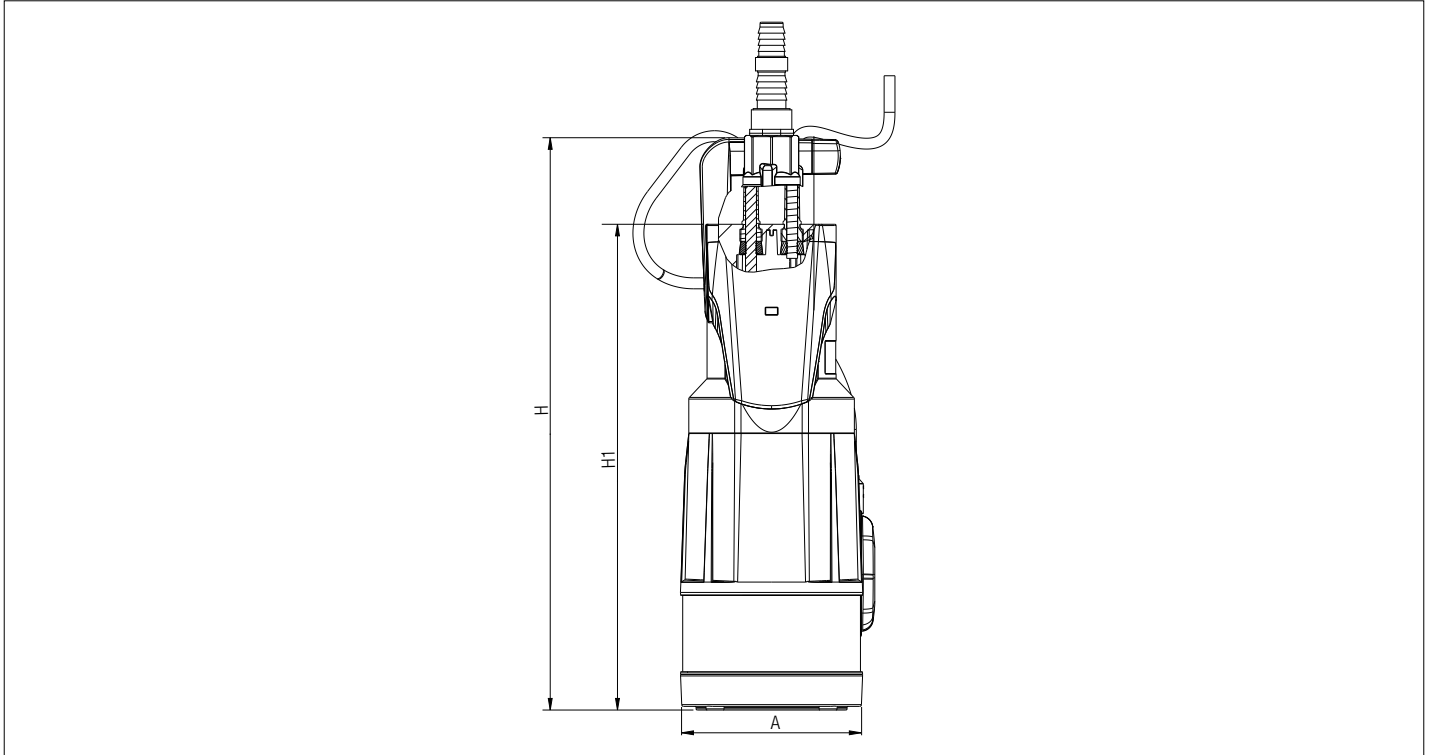

MODEL	A	H	H1	Ø	PACKING DIMENSIONS			PACKING VOLUME ft ³	Q.TY X PALLET	WEIGHT lbs
					L/A	L/B	H			
DIVER 6 - 600 M-A	5.9	16.7	13.9	1"	9.1	7.5	19.7	0.7	40	17.7
DIVER 6 - 700 M-A	5.9	18.5	15.7	1"	9.1	7.5	19.7	0.7	40	20.5
DIVER 6 - 800 M-A	5.9	18.5	15.7	1"	9.1	7.5	19.7	0.7	40	20.8

DTRON 2

7" ELECTRONIC MULTISTAGE SUBMERSIBLE PUMPS



7" submersible electronic multi-impeller pump designed for use in water wells, tanks or cisterns. The pump is suitable for use in residential building service for pressurization, rainwater reuse and gardening and irrigation. The pressure switch and flow switch integrated with the electronic board, make the pump completely automatic for the switching on/off and dry running protection. It integrates a double mechanical seal, a non return valve and a handle for ease transport and installation. Built with an innovative modular design: the hydraulic part, the motor, the electrical part and the filter can be disassembled separately, simplifying the maintenance activity.

The suction height is adjustable from the bottom up to 3.1m using the special accessory supplied as standard. It is possible to connect a float without compromising the watertight seal of the pump thanks to the NFC (Near Field Communication) pocket. The integrated expansion tank protect from water hammer, an additional expansion tank is not required. The cable has a quick coupling for easier installation inside the tank/cistern.

The pump is also available in X version with 1" intake and kit X to connect to suction hose and float to prevent the suction of impurities from the bottom. The whole pump is IP 68 certified, with the accessory DOC68 (supplied separately) becomes a surface pump to be used with flooded suction.

Maximum immersion depth 39 ft

Type of pumped liquid clean, free from solid or abrasive substances, non-viscous, non-aggressive, non-crystallized and chemically neutral.

Free passage 0.1 in

Liquid temperature range from 32°F to +122°F

Maximum immersion depth 49 ft

Set cut-in 35 psi

Outlet connection thread 1" 1/4

Pump maximum diameter 7.3 in

Protection class IP 68

Motor insulation class F

Power cable with plug 49 ft

Possible type of installation fixed, horizontal or vertical. Submerged or semi-submerged. It can be installed on the surface, under the water level, or outside in a vertical position with the DOC68 accessory (supplied separately).

DTRON 2



ACCESSORIES
PAG. 127

TECHNICAL DATA

MODEL	CODE	VOLTAGE 60 Hz	P2 NOMINAL		P1 MAX W	In A
			kW	HP		
DTRON 2 45/90	60195643	115/60	0.67	0.9	1050	9.7
DTRON 2 35/120	60197690	115/60	0.67	0.9	950	8.8

X VERSION

MODEL	CODE
DTRON2 X 45/90	60202763
DTRON2 X 35/120	60202764



*DTron X with the floating suction kit

DTRON 2

7" ELECTRONIC MULTISTAGE SUBMERSIBLE PUMPS

RANGE PERFORMANCE

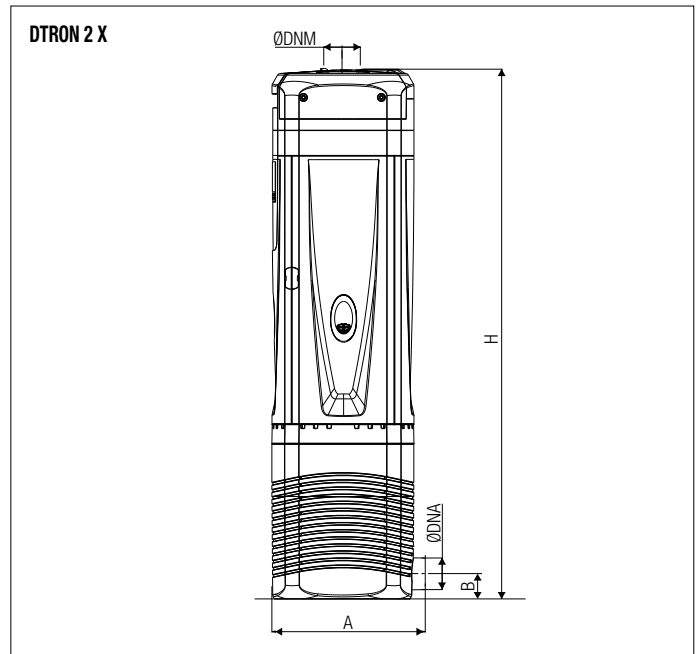
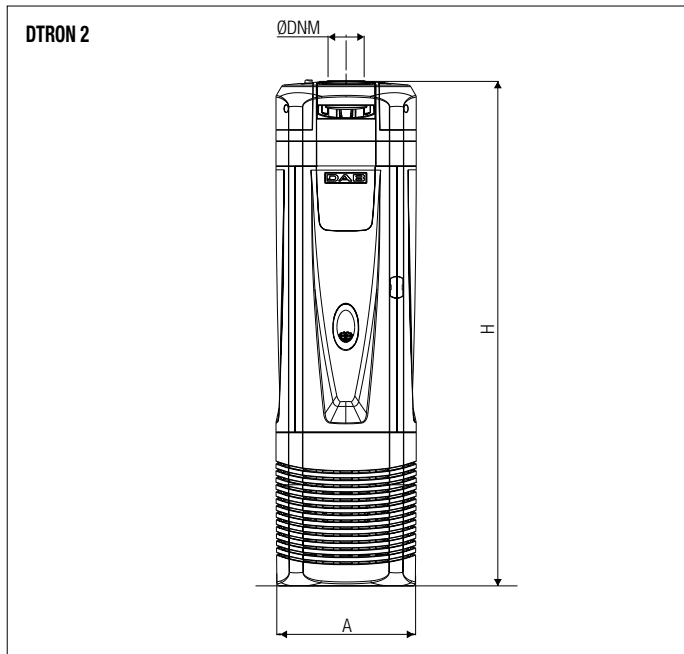
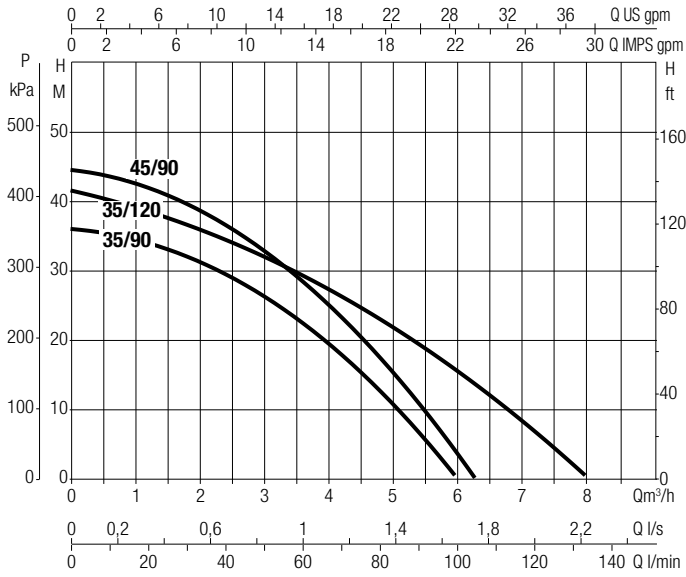

DIMENSIONS AND WEIGHTS

MODEL	A	B	H	Ø DNM	Ø DNA	PACKING DIMENSIONS			PACKING VOLUME ft³	Q.TY X PALLET	WEIGHT lbs
						L/A	L/B	H			
DTRON2 45/90	7.3	-	24.1	1" 1/4	-	29.1	9.1	11.8	1.8	15	25.1
DTRON2 35/120	7.3	-	25	1" 1/4	-	29.1	9.1	11.8	1.8	15	25.1
DTRON2 X 45/90	7.7	1.3	25	1" 1/4	1"	29.1	9.1	11.8	1.8	15	25.4
DTRON2 X 35/120	7.7	1.3	24.1	1" 1/4	1"	29.1	9.1	11.8	1.8	15	25.4

DTRON 3

7" ELECTRONIC MULTISTAGE SUBMERSIBLE PUMPS



7" electronic submersible multi-impeller pump for clean water designed for use in wells, cisterns or tanks. It can be used submerged, partially submerged or on the surface (with the DOC68 accessory).

It is suitable for use in residential building service for pressurization, reuse of rainwater and gardening and irrigation activities. The pressure sensor and a flow meter integrated with the electronic board, make the pump completely automatic for the switching on/off and dry running protection. It integrates a double mechanical seal, a non return valve and a handle for ease transport and installation. Suction height can be adjusted from the bottom up to 3.1" using the special accessory supplied as standard. It is possible to connect a float without compromising the watertight seal of the pump thanks to the NFC (Near Field Communication) pocket. The integrated expansion tank protect from water hammer, an additional expansion tank is not required. The cable has a quick coupling for easier installation inside the tank/cistern.

The pump is also available in X version with 1" intake and kit X to connect to a suction hose and float to prevent the suction of impurities from the bottom. The whole pump is IP 68 certified, with the accessory DOC68 (supplied separately) becomes a surface pump to be used with flooded suction..

Maximum immersion depth 39 ft

Type of pumped liquid clean, free from solid or abrasive substances, non-viscous, non-aggressive, non-crystallized and chemically neutral

Free passage 0.1 in

Liquid temperature range from 32 F to +122F

Maximum immersion depth 49 ft

Set cut-in 35 psi

Outlet connection Thread 1" 1/4

Pump maximum diameter 7.3 in

Protection class IP 68

Motor insulation class F

Power cable with plug 39 ft

Possible type of installation fixed, horizontal or vertical. Submerged or semi-submerged. It can be installed on the surface, under the water level, or outside in a vertical position with the DOC68 accessory (supplied separately).

DTRON 3



ACCESSORIES
PAG. 127

TECHNICAL DATA

MODEL	CODE	VOLTAGE 60 Hz	P2 NOMINAL		P1 MAX W	In A
			kW	HP		
DTRON 3 45/90	60195642	115/60	0.67	0.9	1050	9.7
DTRON 3 35/120	60197703	115/60	0.67	0.9	950	8.8

X VERSION

MODEL	CODE
DTRON3 X 45/90	60202766
DTRON3 X 35/120	60202767



*DTron X with the floating suction kit

DTRON 3

7" ELECTRONIC MULTISTAGE SUBMERSIBLE PUMPS

RANGE PERFORMANCE

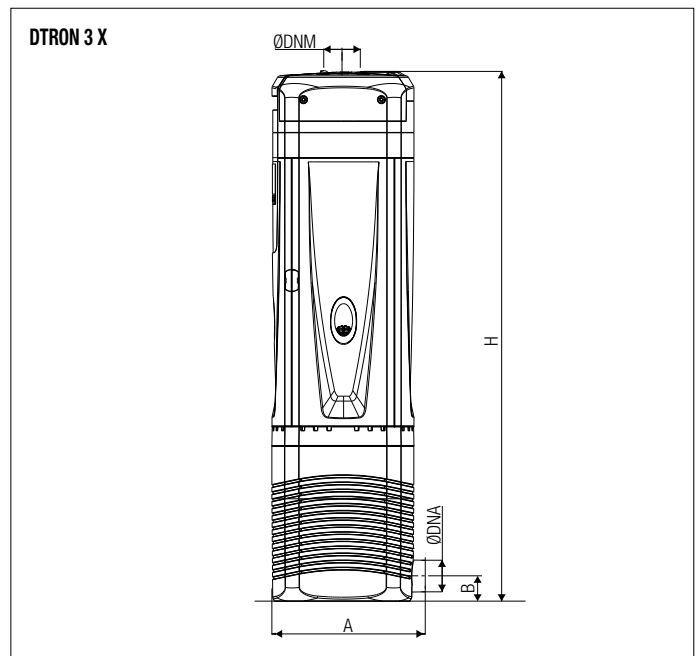
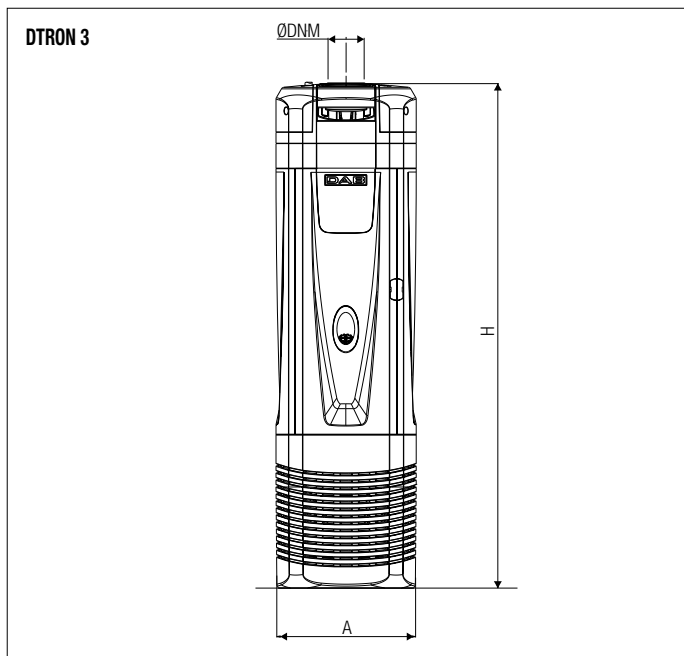
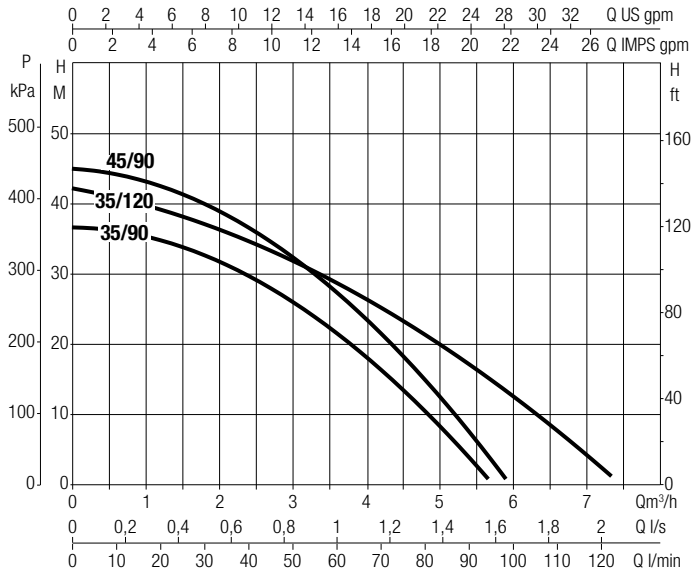







DIMENSIONS AND WEIGHTS

MODEL	A	B	H	$\varnothing\text{DNM}$	$\varnothing\text{DNA}$	PACKING DIMENSIONS			PACKING VOLUME ft ³	Q.TY X PALLET	WEIGHT lbs
						L/A	L/B	H			
DTRON3 45/90	7.3	-	25.6	1" 1/4	-	30.7	9.1	11.8	1.9	15	25.6
DTRON3 35/120	7.3	-	25.6	1" 1/4	-	30.7	9.1	11.8	1.9	15	25.6
DTRON3 X 45/90	7.7	1.3	26.6	1" 1/4	1"	30.7	9.1	11.8	1.9	15	25.8
DTRON3 X 35/120	7.7	1.3	26.6	1" 1/4	1"	30.7	9.1	11.8	1.9	15	25.8

ACCESSORIES

SUBMERSIBLE PUMPS AND MOTORS

DTRON ACCESSORIES	DESCRIPTION	CODE
  	<p>DCONNECT BOX 2</p> <p>Thanks to DConnect Box 2 and the new App you can check the pump, set the starting and stopping parameters, view the details of alarms and monitor the status of the system directly on your smartphone. (Only for DTron 3 and Eskybox Line products, included with Eskybox Diver).</p>	<p>60198035 NEMA 5 PLUG to 120v NEMA 5/15P</p> <p>60198037 NEMA 6 PLUG to 230v NEMA 6/15P</p>
	<p>NFC WATER LEVEL MEASUREMENT</p> <p>Only connected to the DConnect Box 2, controls the level of water in the tank and notifies the user of the level via an App. (Only for DTron 3 and Eskybox diver).</p>	<p>60184570</p>
	<p>NFC FLOAT</p> <p>Detects the level of water in a tank, preventing emptying of the latter and seizing of the pump avoiding the dry running, due to too low a level of water.</p>	<p>60184577</p>
	<p>DOC68</p> <p>The DOC68 permits installation of the DTron and Eskybox Diver even outdoors as an IP68 certified surface pump.</p>	<p>60192276</p>

ACCESSORIES



SUBMERSIBLE PUMPS AND MOTORS

ACCESSORIES

SUBMERSIBLE PUMPS AND MOTORS

CONTROL BOX - USA VERSION

- Version with metal casing.
- PLUS version contains a magnetic line contactor carefully matched to the motor, eliminating the need for an external line contactor.

4GG / 4GX ACCESSORIES	DESCRIPTION	CODE	4GG	4GX
 	CONTROL BOX 4CBUS 1.5HP 230V 60HZ BASIC TESLA	60174733	•	•
	CONTROL BOX 4CBUS 2HP 230V 60HZ BASIC TESLA	60174734	•	•
	CONTROL BOX 4CBUS 3HP 230V 60HZ BASIC TESLA	60174735	•	•
	CONTROL BOX 4CBUS 5HP 230V 60HZ BASIC TESLA	60174736	•	•
	CONTROL BOX 4CBUS 1.5HP 230V 60HZ PLUS TESLA	60174737	•	•
	CONTROL BOX 4CBUS 2HP 230V 60HZ PLUS TESLA	60174738	•	•
	CONTROL BOX 4CBUS 3HP 230V 60HZ PLUS TESLA	60174739	•	•
	CONTROL BOX 4CBUS 5HP 230V 60HZ PLUS TESLA	60174740	•	•

TECHNICAL DATA - FOR MOTORS 4GG - 4GX

MODEL	CODE	P2		V [V]	C1 [μF]	C1 [V]	C2 [μF]	C2 [V]
		[hp]	[kW]					
CONTROL BOX 4CBUS 1.5HP 230V	60174733	1.5	1.1	230	10	370	105-126	250
CONTROL BOX 4CBUS 2HP 230V	60174734	2	1.5	230	20	370	105-126	250
CONTROL BOX 4CBUS 3HP 230V	60174735	3	2.2	230	45	370	208-250	250
CONTROL BOX 4CBUS 5HP 230V	60174736	5	3.0	230	2x40	370	270-324	250
CONTROL BOX 4CBUS 1.5HP 230V	60174737	1.5	1.1	230	10	370	105-126	250
CONTROL BOX 4CBUS 2HP 230V	60174738	2	1.5	230	20	370	105-126	250
CONTROL BOX 4CBUS 3HP 230V	60174739	3	2.2	230	45	370	208-250	250
CONTROL BOX 4CBUS 5HP 230V	60174740	5	3.0	230	2x40	370	270-324	250

ACCESSORIES

SUBMERSIBLE PUMPS AND MOTORS

DIMENSIONS AND WEIGHTS

MODEL	A x B x C [inch]	WEIGHT lbs
CONTROL BOX 4CBUS 1.5HP 230V	8.3" x 9.8" x 5.9"	5.6
CONTROL BOX 4CBUS 2HP 230V	8.3" x 9.8" x 5.9"	5.8
CONTROL BOX 4CBUS 3HP 230V	8.3" x 9.8" x 5.9"	5.8
CONTROL BOX 4CBUS 5HP 230V	8.3" x 9.8" x 5.9"	5.8
CONTROL BOX 4CBUS 1.5HP 230V	8.3" x 9.8" x 5.9"	5.8
CONTROL BOX 4CBUS 2HP 230V	8.3" x 9.8" x 5.9"	5.9
CONTROL BOX 4CBUS 3HP 230V	8.3" x 9.8" x 5.9"	6.0
CONTROL BOX 4CBUS 5HP 230V	8.3" x 9.8" x 5.9"	6.0

POS.	INCH	POS.	INCH
A	8.3"	G	1" Conduit
B	9.8"	H	1/2" Conduit
C	5.9"		

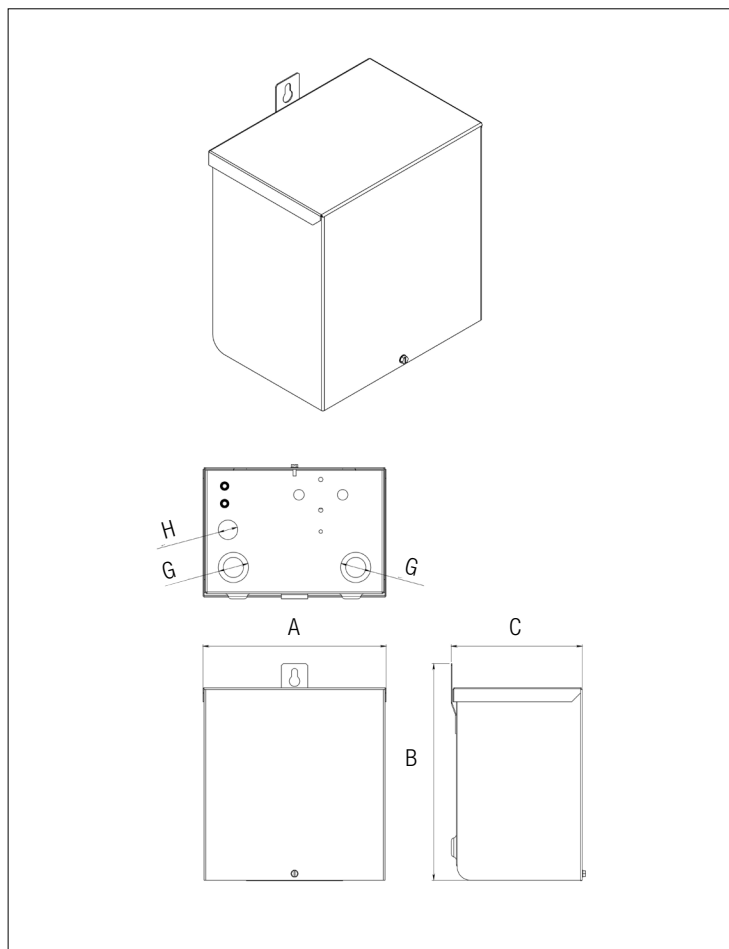



ACCESSORIES

SUBMERSIBLE PUMPS AND MOTORS

CONTROL BOX - USA VERSION

- Version with metal casing.
- Version with auxiliary contacts for control by probes, pressure switch and or float switch.

4GG / 4GX ACCESSORIES	DESCRIPTION	CODE	4GG	4GX
 	CONTROL BOX 4CBUS 0.5HP 115V 60HZ BASIC TESLA	60174729	•	•
	CONTROL BOX 4CBUS 0.5HP 230V 60HZ BASIC TESLA	60174730	•	•
	CONTROL BOX 4CBUS 0.75HP 230V 60HZ BASIC TESLA	60174731	•	•
	CONTROL BOX 4CBUS 1HP 230V 60HZ BASIC TESLA	60184859	•	•

TECHNICAL DATA - FOR MOTORS 4GG - 4GX

MODEL	CODE	P2		V [V]	C [μF]	C [V]
		[HP]	[kW]			
CONTROL BOX 4CBUS 0.5HP 115V	60174729	0.5	0.37	115	250-300	125
CONTROL BOX 4CBUS 0.5HP 230V	60174730	0.5	0.37	230	59-71	250
CONTROL BOX 4CBUS 0.75HP 230V	60174731	0.75	0.55	230	86-103	250
CONTROL BOX 4CBUS 1HP 230V	60184859	1	0.75	230	105-126	250

DIMENSIONS AND WEIGHTS

MODEL	A x B x C [inch]	WEIGHT lbs
CONTROL BOX 4CBUS 0.5HP 115V	4.9" x 8.2" x 2.9"	2.8
CONTROL BOX 4CBUS 0.5HP 230V	4.9" x 8.2" x 2.9"	2.4
CONTROL BOX 4CBUS 0.75HP 230V	4.9" x 8.2" x 2.9"	2.4
CONTROL BOX 4CBUS 1HP 230V	4.9" x 8.2" x 2.9"	2.6

POS.	INCH	POS.	INCH
A	4.9"	G	1/2" conduit
B	8.2"	H	3/4" conduit
C	2.9"		

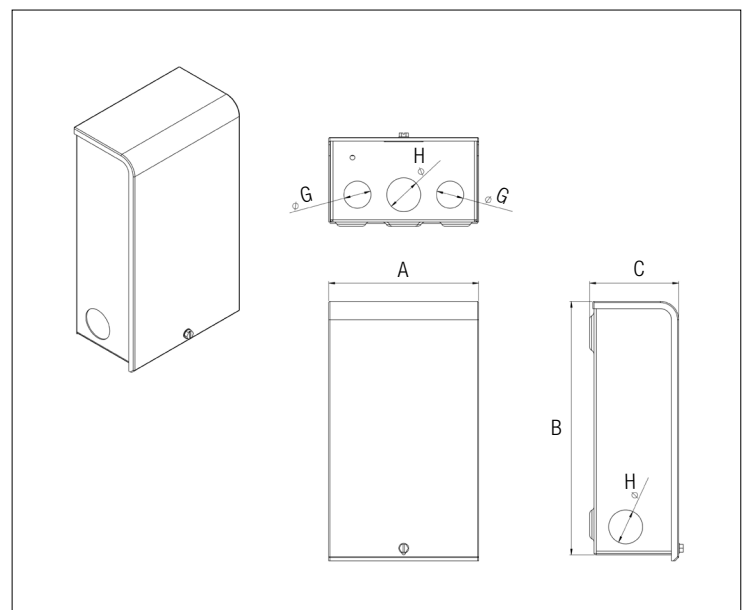



ACCESSORIES

SUBMERSIBLE PUMPS AND MOTORS

CONTROL BOX - USA VERSION

- Version with metal casing.
- Version with auxiliary contacts for control by probes, pressure switch and or float switch.

6GF / 6GX ACCESSORIES	DESCRIPTION	CODE	6GF	6GX
 	CONTROL BOX 6CBUS 7.5HP 230V 60HZ PLUS TESLA	60184860	•	•
	CONTROL BOX 6CBUS 10HP 230V 60HZ PLUS TESLA	60184861	•	•
	CONTROL BOX 6CBUS 15HP 230V 60HZ PLUS TESLA	60184862	•	•

TECHNICAL DATA - FOR MOTORS 6GF - 6GX

MODEL	CODE	P2		V [V]	RUN CAP		START CAPS.	
		[hp]	[kW]		[μF]	[V]	[μF]	[V]
CONTROL BOX 6CBUS 7.5HP 230V	60184860	7.5	5.5	230	45	370	270-324	330
							216-260	330
CONTROL BOX 6CBUS 10HP 230V	60184861	10	7.5	230	35	370	270-324	330
					35	370	216-260	330
							130-156	330
CONTROL BOX 6CBUS 15HP 230V	60184862	15	11	230	45	370	270-324	330
					45	370	270-324	330
					45	370	161-193	330

DIMENSIONS AND WEIGHTS

MODEL	A x B x C [inch]	WEIGHT lbs
CONTROL BOX 6CBUS 7.5HP 230V	8.25 x 15.39 x 6.42	12.00
CONTROL BOX 6CBUS 10HP 230V	8.25 x 15.39 x 6.42	13.55
CONTROL BOX 6CBUS 15HP 230V	8.25 x 15.39 x 6.42	15.65

POS.	INCH	POS.	INCH
A	8.25	F	1/2
B	15.39	G	3/4
C	6.42	H	1
D	16.54	I	1
E	6.56	L	1-1/4

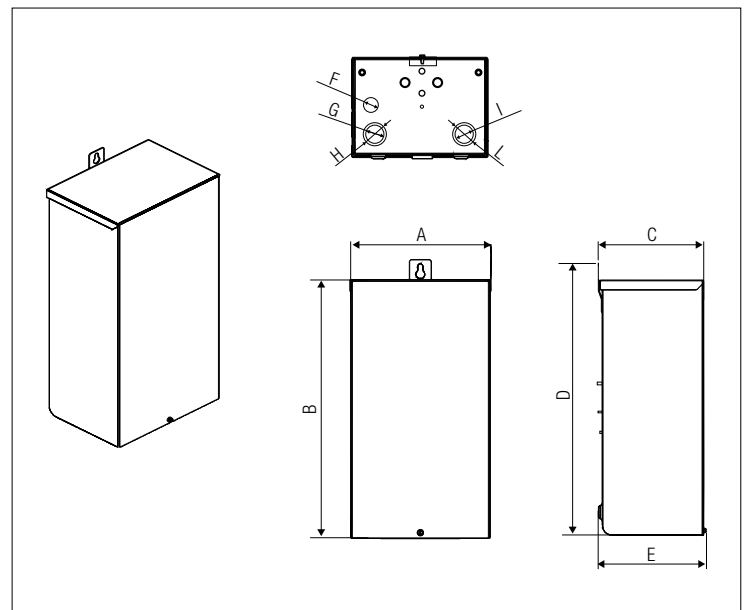

ACCESSORIES

SUBMERSIBLE PUMPS AND MOTORS

TR6 / TR8 / TR10 / TR12 / TR14 ACCESSORIES	DESCRIPTION	CODE	TR6 / TR8	TR10 / TR12 TR14 CAST IRON AND AISI 316	TR10 / TR12 TR14 AISI 904
	KIT, PT100 6"-8" STD/N/R - CABLE 492FT	60199224	•		
	KIT, PT100 6"-8" STD/N/R - CABLE 656FT	60199225	•		
	KIT, PT100 6"-8" STD/N/R - CABLE 820FT	60199226	•		
	KIT, PT100 6"-8" STD/N/R - CABLE 984FT	60199227	•		
	KIT, PT100 6"-8" STD/N/R - CABLE 1312FT	60199228	•		
	KIT, PT100 10"-12"-14" STD/N - CABLE 33FT	60199229		•	
	KIT, PT100 10"-12"-14" STD/N - CABLE 66FT	60199230		•	
	KIT, PT100 10"-12"-14" STD/N - CABLE 131FT	60199231		•	
	KIT, PT100 10"-12"-14" STD/N - CABLE 197FT	60199232		•	
	KIT, PT100 10"-12"-14" STD/N - CABLE 262FT	60199233		•	
	KIT, PT100 10"-12"-14" STD/N - CABLE 328FT	60199234		•	
	KIT, PT100 10"-12"-14" STD/N - CABLE 492FT	60199235		•	
	KIT, PT100 10"-12"-14" STD/N - CABLE 656FT	60199236		•	
	KIT, PT100 10"-12"-14" STD/N - CABLE 820FT	60199237		•	
	KIT, PT100 10"-12"-14" STD/N - CABLE 1312FT	60199238		•	
	KIT, PT100 10"-12"-14" R - CABLE 26FT	60199239			•
	KIT, PT100 10"-12"-14" R - CABLE 98FT	60199240			•



NOVA 40th
SUBMERSIBLE PUMPS FOR DRAINAGE

PAGE 134



DRENAG 1000 - 1200
SUBMERSIBLE PUMPS

PAGE 143



NOVA UP
SUBMERSIBLE PUMPS

PAGE 136



FEKA VS
SEWAGE PUMPS

PAGE 145



VERTY NOVA
INTEGRATED FLOAT SWITCH SUBMERSIBLE PUMPS

PAGE 137



DRENAG FX
SUBMERSIBLE PUMPS FOR DRAINAGE OF SANDY WATER AND WATER FROM CONSTRUCTION SITE

PAGE 147



FEKA 40TH
SUBMERSIBLE PUMPS FOR EFFLUENT

PAGE 138



GRINDER FX
SUBMERSIBLE PUMPS WITH CUTTING SYSTEM FOR SEWAGE

PAGE 149



CLEAR ANSWER
PUMPS FOR POUND FOUNTAINS & WATER FALLS

PAGE 140



FEKA FXC
SUBMERSIBLE PUMPS FOR EFFLUENT

PAGE 151



SOLID ANSWER
PUMPS FOR POUND FOUNTAINS & WATER FALLS

PAGE 141



FEKA FXV
SUBMERSIBLE PUMPS FOR SEWAGE

PAGE 154



FEKA BVP
SEWAGE PUMPS

PAGE 142

ACCESSORIES

PAGE 159

NOVA 40th

SUBMERSIBLE PUMPS FOR DRAINAGE



NOVA M-A

NOVA M-NA



Submersible pump for drainage also rainwater in residential building service. The Nova series has been redesigned to mark forty years of commercialization, making it even more reliable, resistant and ergonomic. It can also be used for emptying tanks or cisterns.

It is suitable for fixed or portable installations and it is available in the automatic version with the integrated float switch or in the manual version without the float. The pump is suitable for draining flooded basements, cellars and garages or to prevent flooding when installed in rainwater collection wells, and can be used as a portable pump in emergency situations to drain water from flooded premises. A 90° fitting is provided for vertical delivery. The pump body, the impeller and the suction grid are in technopolymer, the motor shaft is in stainless steel. Thermal protection incorporated in all single-phase versions. It can work in dry run for up to 1 minute. 0.4" free passage. In compliance with CSA Standards C22.2 No.108 - 14, UL Standard No. 778.

Flow rate minimum and maximum
from 4.4 to 70.4 GPM

Head up to 33 ft

Type of pumped liquid
drainage water, mostly celan, rainwater

Free passage
0.2 in or 0.4 in depending on the model

Supported liquid temperature (maximum and minimum)

from 32°F to +95°F for domestic use
from 32°F to +122°F other use

Outlet connection threaded 1" 1/4

Impeller material technopolymer

Class of protection IP 68

Motor insulation class F

Dry run time 1 minute

Possible type of installation
fixed or portable in vertical position

ACCESSORIES
PAG. 159

TECHNICAL DATA

MODEL	CODE	ELECTRICAL DATA						
		VOLTAGE 60 Hz	P1 MAX kW	P2 NOMINAL		In A	CAPACITOR	
				kW	HP		μF	Vc
NOVA 180 MA	60198429H	115-120	0.3	0.1	0.2	2.9	12.5	250
NOVA 180 MNA	60200868H	115-120	0.3	0.1	0.2	2.9	12.5	250
NOVA 200 MNA	60200869H	115-120	0.4	0.2	0.3	3.8	20	250
NOVA 300 MA	60198428H	115-120	0.4	0.2	0.3	3.9	20	250
NOVA 600 MA	60198425H	115-120	0.7	0.5	0.6	6.4	20	250
NOVA 600 MNA	60200870H	115-120	0.7	0.5	0.6	6.4	20	250

RANGE PERFORMANCE

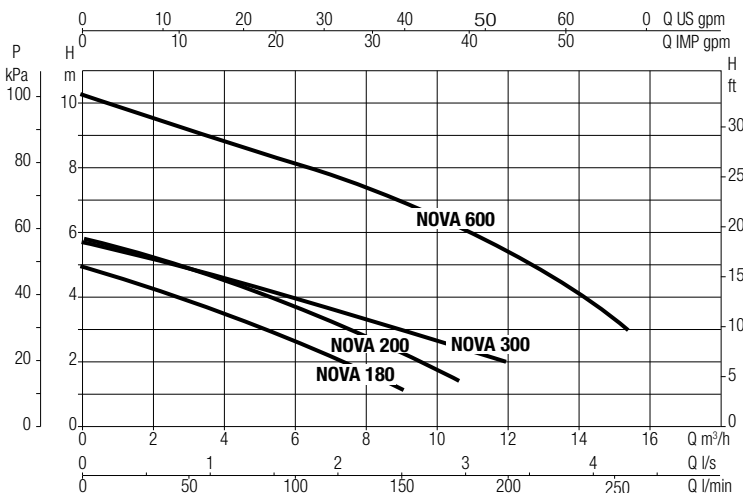

NOVA 40th

SUBMERSIBLE PUMPS FOR DRAINAGE

DIMENSIONS AND WEIGHT

NOVA 180/200

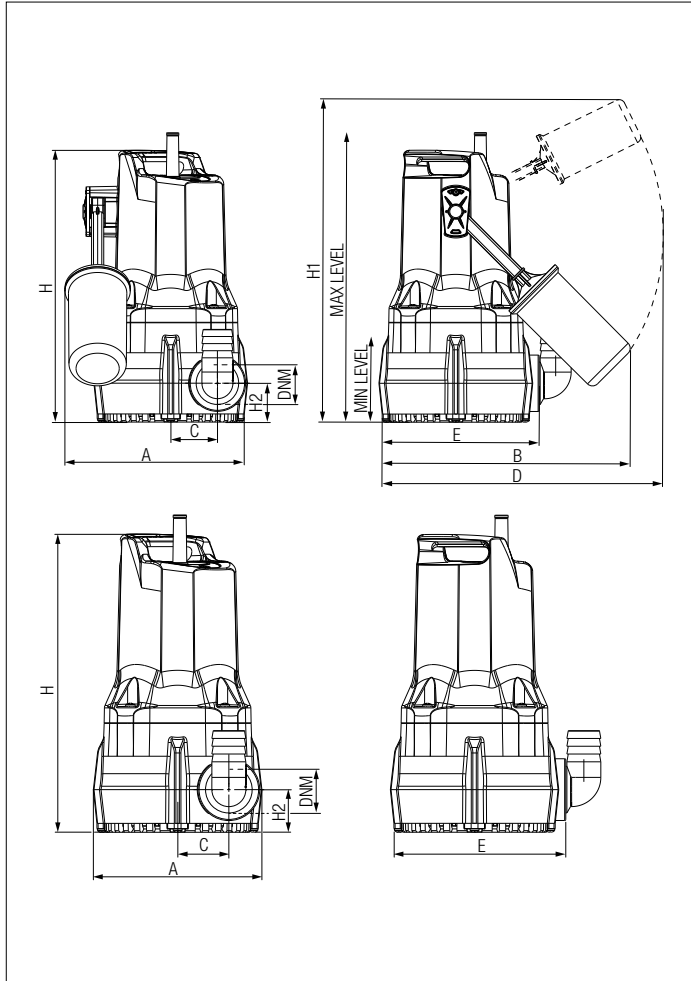

NOVA 300/600

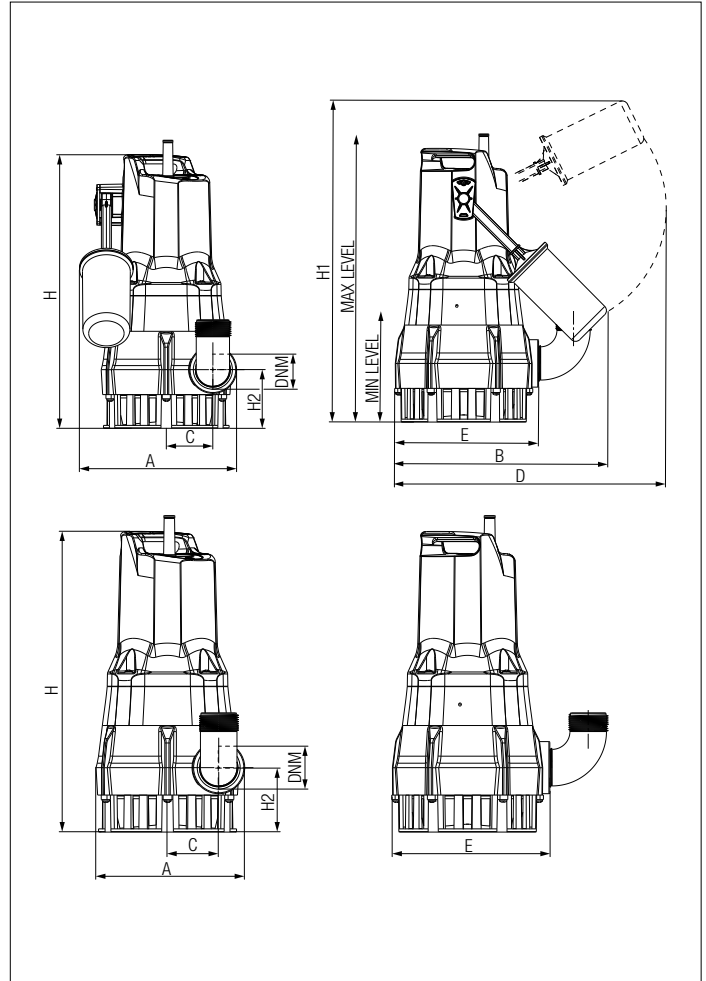

MODEL	A	B	C	D	E	H	H1	H2	LEV. MIN	DNM NPT	PACKING DIMENSIONS			CABLE LENGHT (ft)	VOLUME (ft ³)	WEIGHT lbs
											L/A	L/B	H			
NOVA 180 MA	7.1	9.7	1.8	11.7	6.2	10.6	13.6	1.5	3	1"1/4	11.3	8	12.6	16	0.7	10.1
NOVA 180 MNA	5.9	-	1.8	-	6.2	10.6	-	1.5	-	1"1/4	11.3	8	12.6	16	0.7	10.1
NOVA 200 MNA	5.9	-	1.8	-	6.2	10.6	-	1.5	-	1"1/4	11.3	8	12.6	16	0.7	10.1
NOVA 300 MA	7.1	9.7	1.8	11.7	6.2	10.9	13.9	1.9	3.3	1"1/4	11.3	8	12.6	16	0.7	10.1
NOVA 600 MA	7.4	10	2.2	11.7	6.9	13	17.4	2.8	7.5	1"1/4	11.3	8	17	16	0.9	15.4
NOVA 600 MNA	6.4	-	2.2	-	6.9	13	-	2.8	-	1"1/4	11.3	8	17	16	0.9	15.4

NOVA UP

SUBMERSIBLE PUMPS



Vertical flow drainage pump in an automatic or manual version with removable filter for suction down to 0.1 inch, features that make it a strong pump and allow for installation versatility.

These pumps can be used with liquids that contain solids of a maximum size up to 0.4 in. Pump body, impeller, Cap and grille in technopolymer. The motor, rotor shaft and screws in stainless steel. Triple O-ring seal with interposed oil Chamber. Asynchronous submersible motor for continuous operation. Stator in a sealed stainless steel enclosure. Rotor mounted on ball bearings greased for life and oversized. Thermal protection incorporated and CAPACITOR permanently connected. In compliance with CSA Standards C22.2 No.108 - 14, UL Standard No. 778.

Operating range
from 4.4 to 66 GPM with TDH up to 33 ft

Temperature range of the liquid
from 32°F to +95°F for domestic use

Pumped liquid temperature
grey waters without fibers

Minimum depth of draft
NOVA UP-300M - 4.7 in
NOVA UP 300M - 2.4 in
NOVA UP 600M - 6.5 in
NOVA UP 600M - 2.8 in

Maximum immersion depth 23 ft

Installation vertical, fixed or portable

Degree of protection IP 68

Insulation class F

TECHNICAL DATA

MODEL	CODE	ELECTRICAL DATA						
		VOLTAGE 60 Hz	P1 MAX kW	P2 NOMINAL		In A	CAPACITOR	
				kW	HP		μF	Vc
NOVA UP 300 MA	60164179.	115	0.38	0.17	0.23	2.8	12.5	250
NOVA UP 600 MA	60164180.	115	0.78	0.45	0.61	5.6	20	250
NOVA UP 300 MNA	60164181.	115	0.38	0.17	0.23	2.8	12.5	250
NOVA UP 600 MNA	60164182.	115	0.78	0.45	0.61	5.6	20	250

RANGE PERFORMANCE

MODEL	Q=GPM	H (ft)													
		0	4.4	8.8	13.2	19.8	22	26.4	30.8	33	39.6	44	52.8	59.4	
NOVA UP 300 MA	H (ft)	25	23	21	18	15	14	12	9	8	3				
NOVA UP 600 MA		32	31	30	28	25	24	22	20	19	15	13	7	1	
NOVA UP 300 MNA		25	23	21	18	15	14	12	9	8	3				
NOVA UP 600 MNA		32	31	30	28	25	24	22	20	19	15	13	7	1	

DIMENSIONS AND WEIGHT

MODEL	L1	L2	DNM NPT	PLUG	LENGTH OF THE CABLE ft	WEIGHT lbs	Q.TY X PALLET
NOVA UP 300 MA	11.6	3	1" ¼	US	26	12.8	39
NOVA UP 300 MNA	13.1	4.4	1" ¼	US	26	12.3	39
NOVA UP 600 MA	13.1	4.4	1" ¼	US	26	16.1	26
NOVA UP 600 MNA	11.7	3	1" ¼	US	26	15.7	26

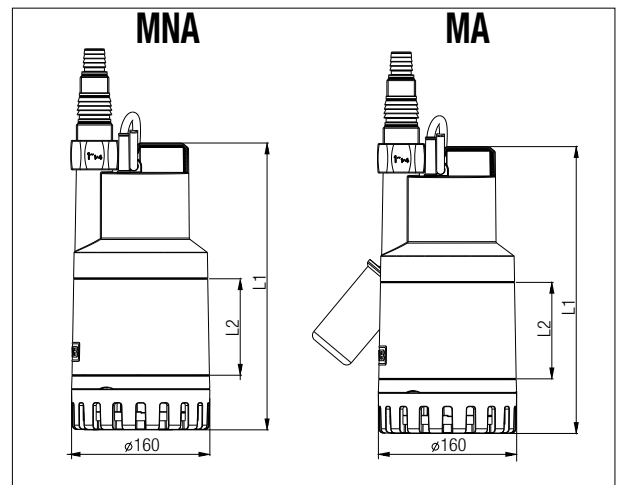

VERTY NOVA

INTEGRATED FLOAT SWITCH SUBMERSIBLE PUMPS



Submersible pumps specifically designed for uses in narrow pits with dimensions down to 7.9 in x 7.9 in. Suitable to pump clear water containing particles with maximum diameter up to 0.2 in.

Pump with built-in float switch

Anti-corrosive and rust-proof materials. Integrated float switch.

Low suction capability: 0.1 in (manual mode).

Very low priming and STARTING level of the pump: 0.4" – 0.6" in (manual mode).

Lever for manual or automatic operation.

Easy access through sliding cover to float switch for cleaning.

Motor with thermal overload protection.

Excellent cooling of the motor that enables the pump to operate even when it is partially submerged.

Supplied with power cable with plug, non return valve and 4-step fitting.

In compliance with CSA Standards C22.2 No.108 - 14, UL Standard No. 778 starting from June 2021.

Operating range

from 4.4 to 52.8 GPM with head up to 30 ft

Liquid temperature range

from 32°F to +95°F for domestic use

Pumped liquid grey water without fibres

Pump priming limit 0.4" - 0.6" in manual operation

Max. immersion depth 23 ft

TECHNICAL DATA

MODEL	CODE	ELECTRICAL DATA						
		VOLTAGE 60 Hz	P1 MAX kW	P2 NOMINAL		In A	CAPACITOR	
				kW	HP		µF	Vc
VERTY NOVA 206 M	60146276H	1x115V~	0.33	0.18	0.25	2.7	12.5	250
VERTY NOVA 406 M	60146278H	1x115V~	0.67	0.37	0.5	7	20	250

RANGE PERFORMANCE

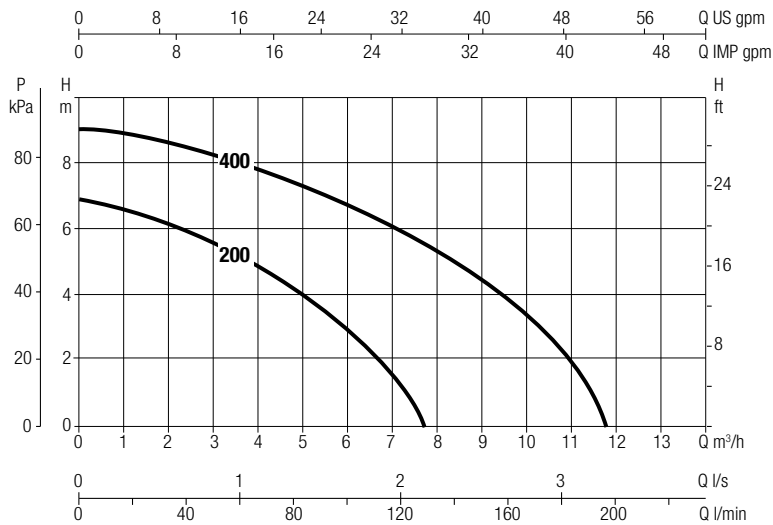

DIMENSIONS AND WEIGHT

MODEL	A	B	C	Ø D	H	H1	DNM (NPT)	CABLE ft	Q.TY x PALLET	WEIGHT lbs
VERTY NOVA 206 M	6.2	8.9	7.9	1.3	15.7	10.4	1"1/4	16	40	9.3
VERTY NOVA 406 M	6.2	8.9	7.9	1.3	15.7	10.4	1"1/4	16	40	11.2

DIMENSIONS

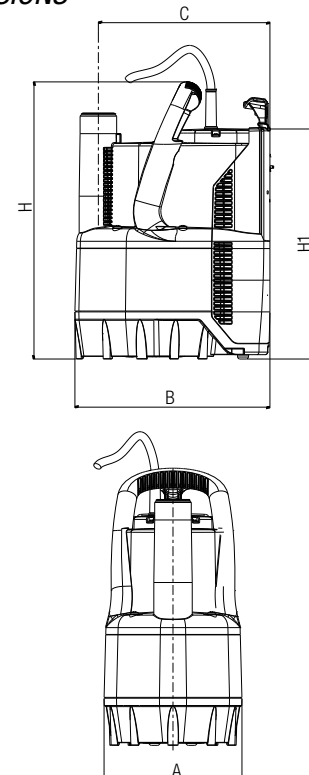

FEKA 40th

SUBMERSIBLE PUMPS FOR EFFLUENT



FEKA M-A

FEKAM-NA



40 YEARS ANNIVERSARY Celebration



Flow rate minimum and maximum
from 4.4 to 70.4 GPM

Head up to 25 ft

Type of pumped liquid wastewater and rainwater

Free passage 1 in

Supported liquid temperature (maximum and minimum) from 32°F to +95°F for domestic use

Class of protection IP 68

Motor insulation class F

Possible type of installation
fixed or portable in vertical position

Submersible pumps suitable for draining and lifting effluent wastewater and rainwater in residential building service. The pumps have been redesigned on the occasion of the forty year anniversary, making them even more reliable, resistant and ergonomic.

The impeller in technopolymer allows the passage of solid bodies up to 1in. The pumps are designed for fixed or mobile installations and are available in automatic versions with integrated float switch or in manual version without float.

The pump body and the inlet grid are in technopolymer, the motor shaft in AISI 431 motor shaft suitable for light salty water.

Robust and reliable, they have a triple ring seal in oil bath and an asynchronous motor with continuous service. Stator inserted in an airtight stainless steel casing and rotor mounted on oversized ball bearings to increase its durability.

Thermal protection incorporated in all single-phase versions. the pumps can run dry for up to 1 minute. New sealed cable gland design and new motors, more compact and efficient. Impeller bolt sealing to prevent corrosion at bolt motor shaft. In compliance with CSA Standards C22.2 No.108 - 14, UL Standard No. 778.

ACCESSORIES
PAG. 159

TECHNICAL DATA

MODEL	CODE	ELECTRICAL DATA						
		VOLTAGE 60 Hz	P1 MAX kW	P2 NOMINAL		In A	CAPACITOR	
				kW	HP		μF	Vc
FEKA 300 MA	60198427H	115-120	0.4	0.2	0.3	4.0	20	250
FEKA 300 MNA	60200871H	115-120	0.4	0.2	0.3	4.0	20	250
FEKA 600 MA	60198424H	115-120	0.7	0.5	0.6	6.3	20	250
FEKA 600 MNA	60200872H	115-120	0.7	0.5	0.6	6.3	20	250

RANGE PERFORMANCE

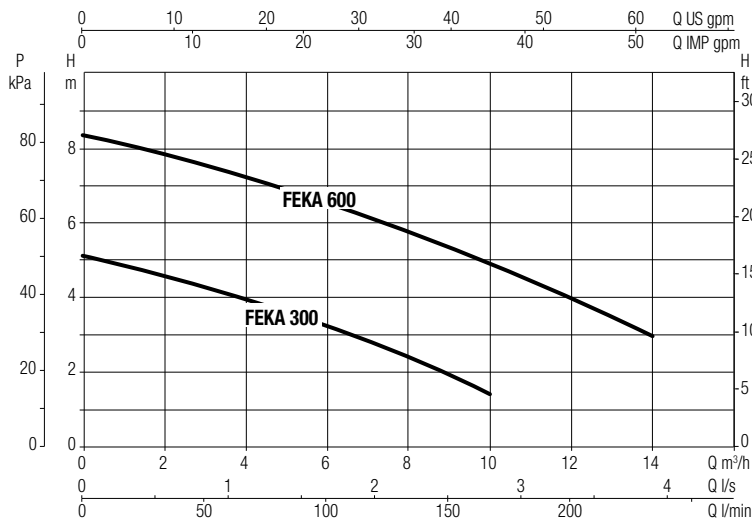

FEKA 40th

SUBMERSIBLE PUMPS FOR EFFLUENT

DIMENSIONS AND WEIGHT

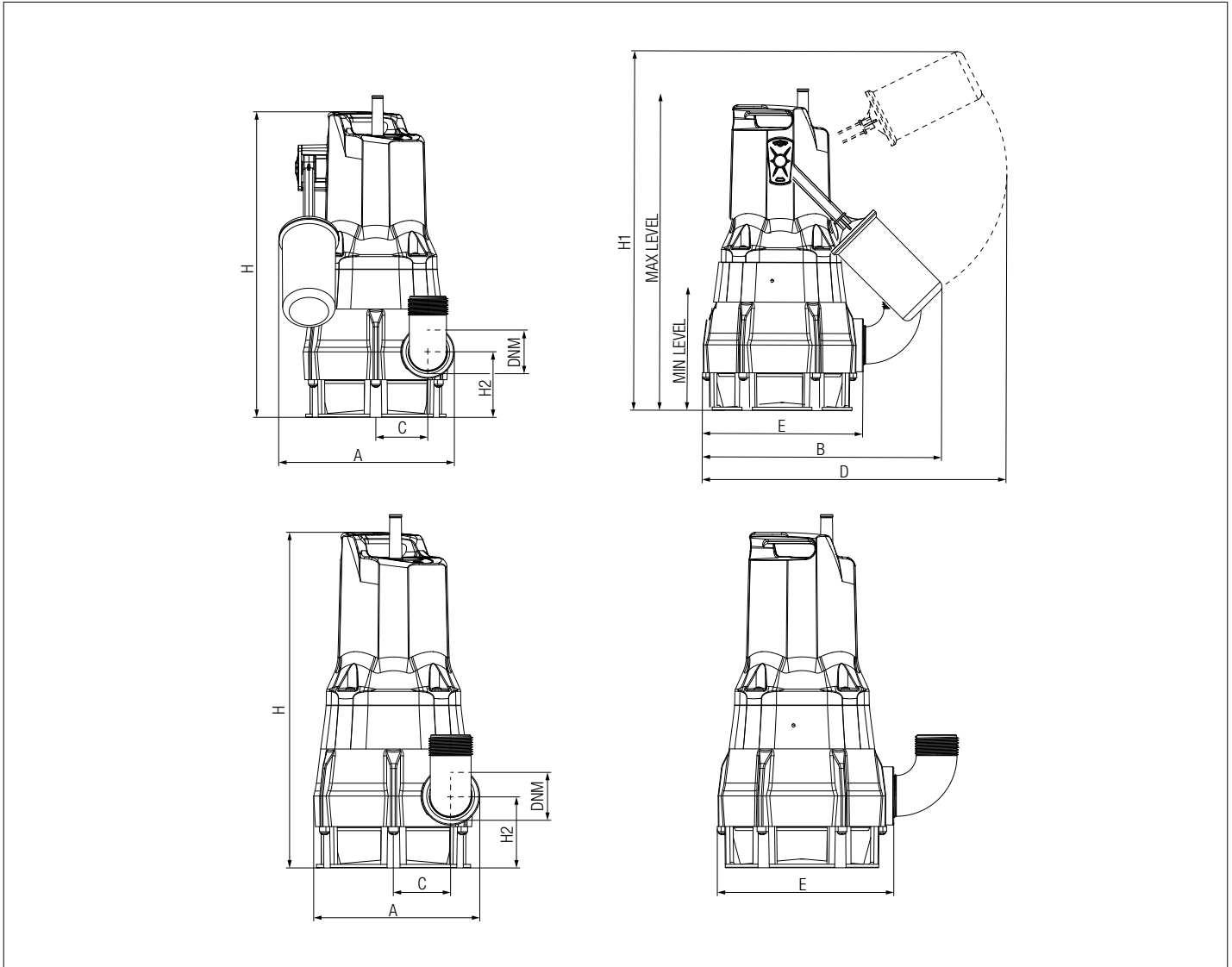

MODEL	A	B	C	D	E	H	H1	H2	LEV. MIN	DNM NPT	PACKING DIMENSIONS			CABLE LENGHT (ft)	VOLUME (ft ³)	WEIGHT lbs
											L/A	L/B	H			
FEKA 300 MA	7.4	10	2.2	11.7	6.9	13	14	2.8	3.7	1"1/4	11.3	8	17	16	0.9	10.1
FEKA 300 MNA	6.4	-	2.2	-	6.9	13	-	2.8	-	1"1/4	11.3	8	17	16	0.9	10.4
FEKA 600 MA	7.4	10	2.2	11.7	6.9	13.7	17.4	2.8	7.5	1"1/4	11.3	8	17	16	0.9	15.4
FEKA 600 MNA	6.4	-	2.2	-	6.9	13.7	-	2.8	-	1"1/4	11.3	8	17	16	0.9	15.4

CLEAR ANSWER

PUMPS FOR POUND FOUNTAINS & WATER FALLS



Submersible pumps to circulate water in garden ponds, create water falls and play water features. Designed to work in both horizontal and vertical installations. Suitable to pump clear water containing particles with maximum diameter up to 1/3".

- Circulating water in Garden ponds
- Water falls
- Fountains
- Water features

In compliance with CSA Standards C22.2 No.108 - 14, UL Standard No. 778.

TECHNICAL DATA

MODEL	CODE	HP	WATTS	VOLTS	FREQUENCY	AMPS	MAX SOLIDS	MAX FLOW	MAX HEAD	DISCHARGE
CLEAR ANSWER 1	60160007	1/4	280	115	60 Hz	2.4	0.3"	31 gpm	21 ft	1" 1/4 NPT
CLEAR ANSWER 2	60160011	1/3	370	115	60 Hz	3.4	0.4"	44 gpm	30 ft	
CLEAR ANSWER 3	60160014	1/2	820	115	60 Hz	7.6	0.4"	70 gpm	34 ft	

RANGE PERFORMANCE

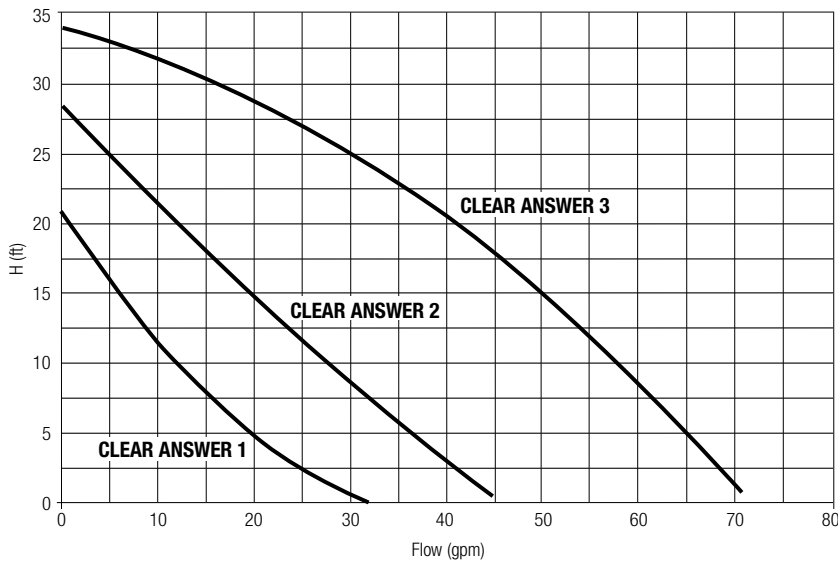

DIMENSIONS

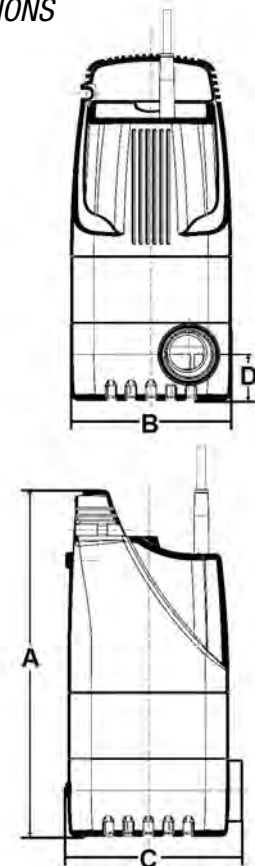

DIMENSIONS AND WEIGHT

MODEL	A	B	C	D	CABLE LENGTH (ft)	WEIGHT lbs	Q.TY x PALLET
CLEAR ANSWER 1	10.5"	5.5"	6.1"	1.6"	16	10.5	54
CLEAR ANSWER 2	10.5"	5.5"	6.1"	1.6"	16	11.0	
CLEAR ANSWER 3	11.8"	5.5"	6.1"	1.6"	16	15.4	

SOLID ANSWER

PUMPS FOR POUND FOUNTAINS & WATER FALLS



Submersible pumps to circulate water in garden ponds, create water falls and play water features. Designed to work in both horizontal and vertical installations. Suitable to pump clear water containing particles with maximum diameter up to 1" 1/4.

- Circulating water in Garden ponds
- Water falls
- Fountains
- Water features

In compliance with CSA Standards C22.2 No.108 - 14, UL Standard No. 778.

TECHNICAL DATA

MODEL	CODE	HP	WATTS	VOLTS	FREQUENCY	AMPS	MAX SOLIDS	MAX FLOW	MAX HEAD	DISCHARGE
SOLID ANSWER 4	60161595	1/4	235	115	60 Hz	1.9	1" 1/4	24 gpm	11.5 ft	1" 1/4 NPT
SOLID ANSWER 5	60161596	1/3	320	115	60 Hz	2.4	1" 1/4	32 gpm	16.4 ft	
SOLID ANSWER 6	60161597	1/2	880	115	60 Hz	8.0	1" 1/4	54 gpm	29.5 ft	

RANGE PERFORMANCE

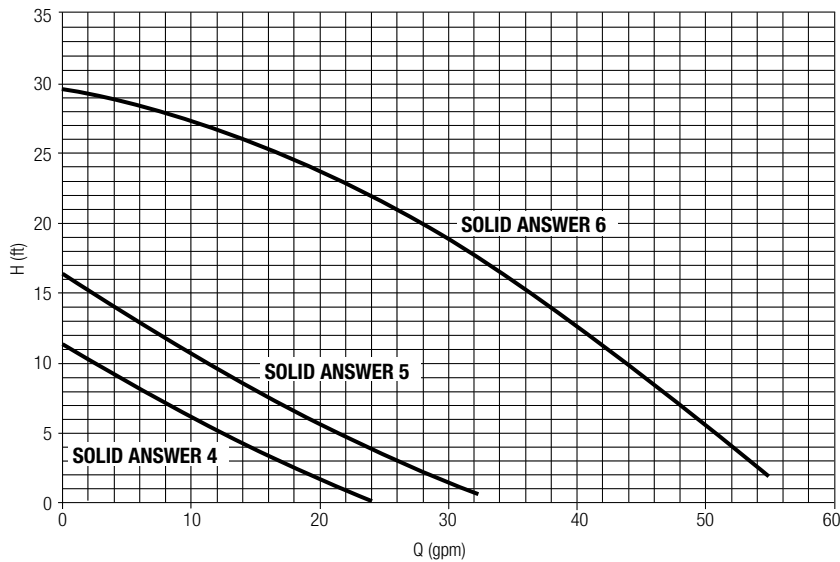

DIMENSIONS

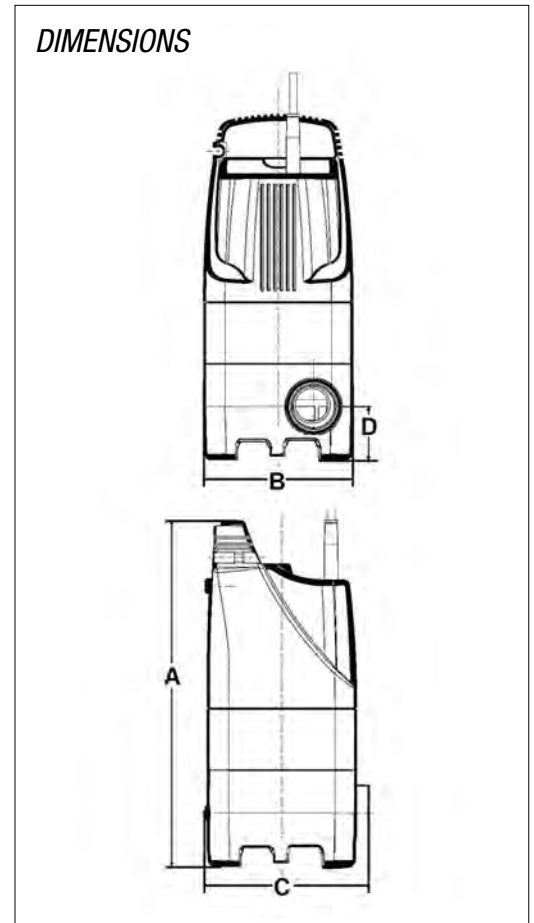

DIMENSIONS AND WEIGHT

MODEL	A	B	C	D	CABLE LENGTH (ft)	WEIGHT lbs	Q.TY x PALLET
SOLID ANSWER 4	10.5"	5.5"	6.1"	1.6"	16	10.5	54
SOLID ANSWER 5	10.5"	5.5"	6.1"	1.6"	16	11.0	
SOLID ANSWER 6	11.8"	5.5"	6.1"	1.6"	16	15.4	



FEKA BVP

SEWAGE PUMPS



Powerful submersible pumps for drainage and emptying duty. Designed for pumping sewage water containing solid particles of no more than 1.5 in in diameter.

Anti-corrosion and anti-oxidation materials.

Motor with THERMALPROTECTION against overheating.

Wear-resistant motor shaft and impeller.

Excellent motor cooling to allow pump to run even when only partially submerged.

Automatic version equipped with float switch for automatic STARTING and stopping of the pump, and Manual version.

Equipped with power cable with plug, and 3-level union, without check valve. In compliance with CSA Standards C22.2 No.108 - 14, UL Standard No. 778.

Operating range

from 4.4 to 105.7 GPM with head up to 39 ft

Liquid temperature range

from 32°F to +95°F

Pumped liquid

Sewage water with maximum solid particle size 1.5 in

Max. immersion depth 23 ft

TECHNICAL DATA

MODEL	CODE	ELECTRICAL DATA						
		VOLTAGE 60 Hz	P1 MAX kW	P2 NOMINAL		In A	CAPACITOR	
				kW	HP		μF	Vc
FEKA BVP 700 M-A	60152204	1x115 V~	1.10	0.71	0.95	10.4	30	250
FEKA BVP 750 M-A	60146279	1x115 V~	1.10	0.71	0.95	10.5	30	250

RANGE PERFORMANCE

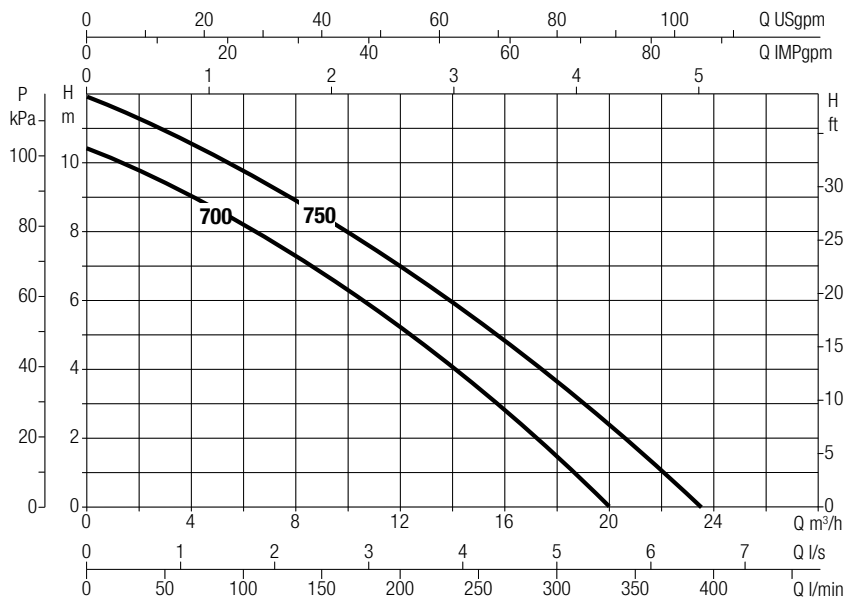

DIMENSIONS

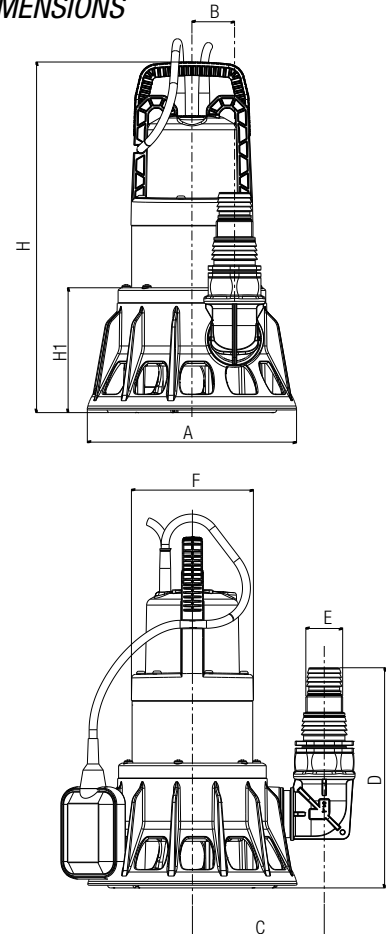

DIMENSIONS AND WEIGHT

MODEL	A	B	C	D	E (NPT)	F	H	H1	DNM (NPT)	CABLE ft	WEIGHT lbs	Q.TY x PALLET
FEKA BVP 700 M-A	9.4	1.9	5.9	9.8	1" 1/4	5.5	15.7	5.6	1" 1/2	16	17.6	27
FEKA BVP 750 M-A	9.4	1.9	5.9	9.8	1" 1/4	5.5	15.7	5.6	1" 1/2	16	17.6	27

DRENAG 1000 - 1200

SUBMERSIBLE PUMPS



Submersible electric pump in AISI 304 Stainless Steel: pump body, impeller, motor flange, filter and filter cover, motor casing, outer casing with handle, cable compartment cover.

Shaft in AISI 316 stainless steel.

Handle coated with insulating rubber. **Double mechanical seal** with oil chamber interposed, carbon/alumina on motor side and silicon/silicon carbide on pump side. **Dry motor**, asynchronous, watertight, cooled by the pumped liquid itself. Standard thermal protection in the winding. Capacitor permanently on in the single-phase version. 33 ft power cables

All models can be supplied either with or without float. In compliance with CSA Standards C22.2 No.108 - 14, UL Standard No. 778.

Operating range

from 13.2 to 105.37 GPM with head up to 47 ft

Liquid temperature range

from 32°F to +95°F for domestic use
from 32°F to +122°F

Pumped liquid characteristics

rain water, ground water, sandy water from building yards and clean waste waters, not aggressive

Maximum working temperature

+104°F with the motor out of the water

Free passage through the suction grid 0.4 in

Maximum immersion depth 23 ft

Protection level IP 68

Insulation class F

Installation fixed or portable, in a vertical position



ACCESSORIES
PAG. 159

TECHNICAL DATA

MODEL	CODE	ELECTRICAL DATA						
		VOLTAGE 60 Hz	P1 MAX kW	P2 NOMINAL		In A	CAPACITOR	
				kW	HP		μF	Vc
DRENAG 1000 MA	60193466	1 ~ 220-230V	1.43	1	1.36	6.63	25	450
DRENAG 1000 MNA	60193468	1 ~ 220-230V	1.43	1	1.36	6.63	25	450
DRENAG 1000 TNA	60193470	3 ~ 220-277V	1.58	1	1.36	2.51	-	-
DRENAG 1200 MA	60193467	1 ~ 220-230V	1.65	1.2	1.6	8.63	30	450
DRENAG 1200 MNA	60193469	1 ~ 220-230V	1.65	1.2	1.6	8.63	30	450
DRENAG 1200 TNA	60193471	3 ~ 220-277V	1.66	1.2	1.6	3.34	-	-

RANGE PERFORMANCE

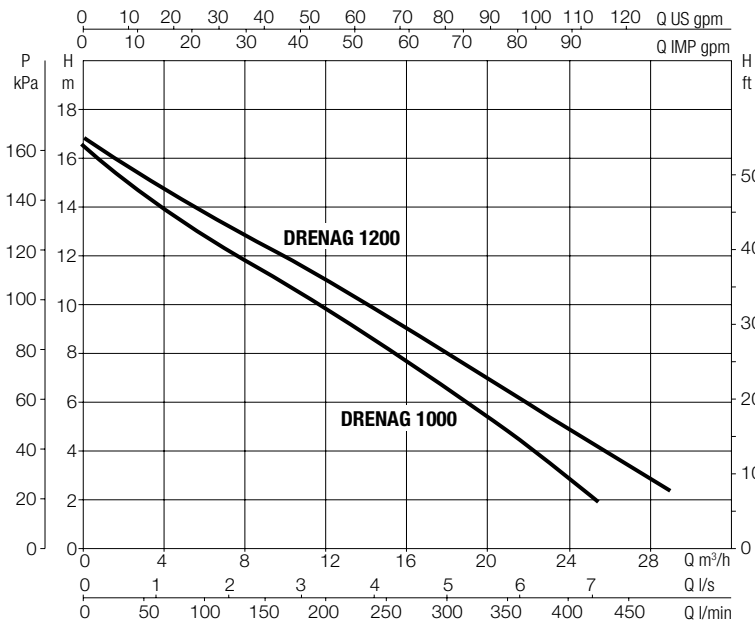

DRENAG 1000 - 1200

SUBMERSIBLE PUMPS

INSTALLATION

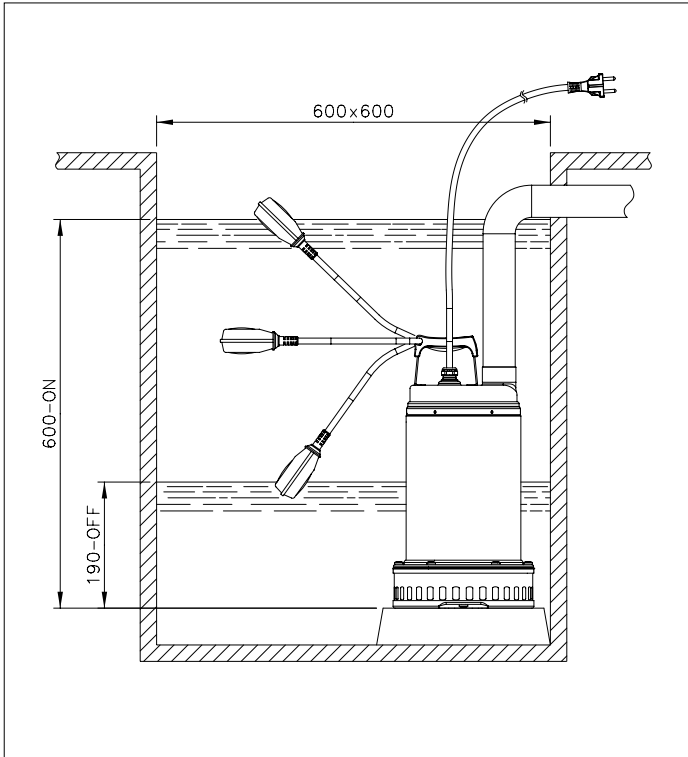

DIMENSIONS

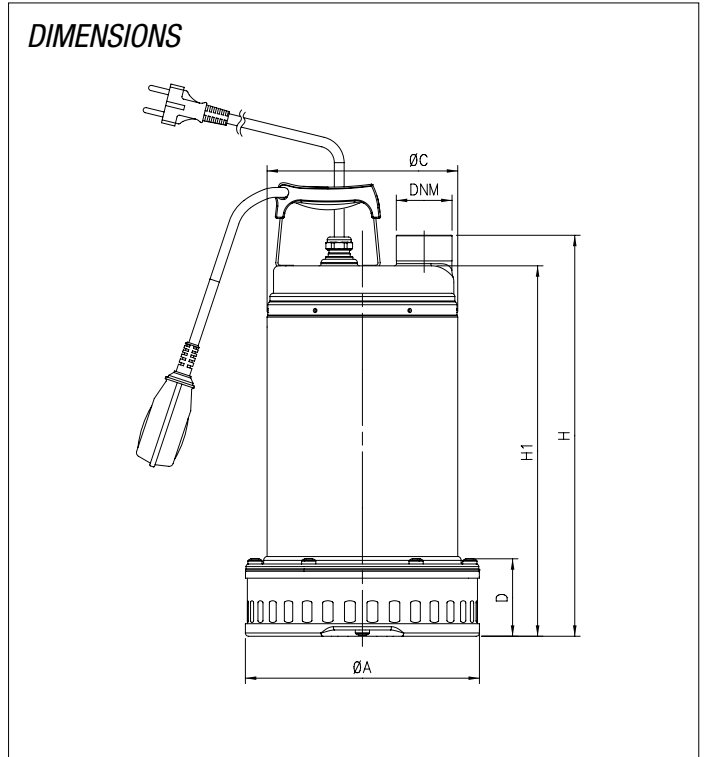

DIMENSIONS AND WEIGHT

MODEL	Ø A	Ø B	H	H1	Ø DNM (NPT)	PACKING DIMENSIONS			CABLE LENGTH (ft)	FREE PASSAGE in	WEIGHT lbs
						L/A	L/B	H			
DRENAG 1000	8.5	6.9	2.8	15.2	1" ½	9.4	23.6	9.8	33	0.4	37.5
DRENAG 1200	8.5	6.9	2.8	15.2	1" ½	9.4	23.6	9.8	33	0.4	40.8

FEKA VS

SEWAGE PUMPS



Submersible centrifugal pump with liquid vortex cast stainless steel impeller, suitable for pumping sewage water and waste water in general containing solids up to a maximum size of 2 in.

Handle with insulating rubber cover. AISI 316 stainless steel drive shaft. Double mechanical seal with intermediate oil chamber (atoxic oil), in carbon/alumina on the motor side and silicon carbide/silicon carbide on the pump side.

Dry, asynchronous, sealed and cooled by the pumped liquid. Rotor mounted on greased for-life ball bearings, oversized and selected to guarantee greater noise reduction and duration. Thermal protection as standard for single-phase version, and the user's responsibility for the three-phase version. Constantly active capacitor on the single-phase version. In compliance with CSA Standards C22.2 No.108 - 14, UL Standard No. 778.

Motor protection class IP 68

Insulation class F

Power supply cable

33 ft of cable with plug for the single-phase version and 33 ft of cable for the three-phase version

Operating range

from 0 to 140.9 GPM with head up to 46 ft

Pumped liquid

sewer water and waste water in general and non aggressive

Liquid temperature range

from 32°F to +95°F for household use (EN 60335-2-41) from 32°F to +122°F for other uses

Maximum ambient temperature for pump

running with submerged motor +104 F

Maximum immersion depth 33 ft

Installation fixed or portable, vertical

Free Passage 2 in



ACCESSORIES
PAG. 159

TECHNICAL DATA

MODEL	CODE	ELECTRICAL DATA						
		VOLTAGE 60 Hz	P1 MAX kW	P2 NOMINAL		In A	CAPACITOR	
				kW	HP		µF	VC
FEKA VS 550 M-A	60193434	1 ~ 115V 60Hz	0.84	0.55	0.75	8.7	50	200
FEKA VS 550 M-A	60193436	1 ~ 220-230V 60Hz	0.91	0.55	0.75	3.9 - 4	20	450
FEKA VS 550 M-NA	60193440	1 ~ 115V 60Hz	0.84	0.55	0.75	8.7	50	200
FEKA VS 550 M-NA	60193442	1 ~ 220-230V 60Hz	0.91	0.55	0.75	3.9 - 4	20	450
FEKA VS 550 T-NA*	60193446	3 ~ 220-277V 60Hz	0.80	0.55	0.75	2.72 - 2.42	-	-
FEKA VS 1000 M-A	60193438	1 ~ 220-230V 60Hz	1.28	1.00	1.36	6.63	25	450
FEKA VS 1000 M-NA	60193444	1 ~ 220-230V 60Hz	1.28	1.00	1.36	6.63	25	450
FEKA VS 1000 T-NA*	60193448	3 ~ 220-277V 60Hz	1.19	1.00	1.36	2.51	-	-
FEKA VS 1200 M-A	60193439	1 ~ 220-230V 60Hz	1.76	1.20	1.60	8.63	30	450
FEKA VS 1200 M-NA	60193445	1 ~ 220-230V 60Hz	1.76	1.20	1.60	8.63	30	450
FEKA VS 1200 T-NA*	60193449	3 ~ 220-277V 60Hz	1.74	1.20	1.60	3.44	-	-

* 3x220/277 V ~ available on request

FEKA VS

SEWAGE PUMPS

RANGE PERFORMANCE

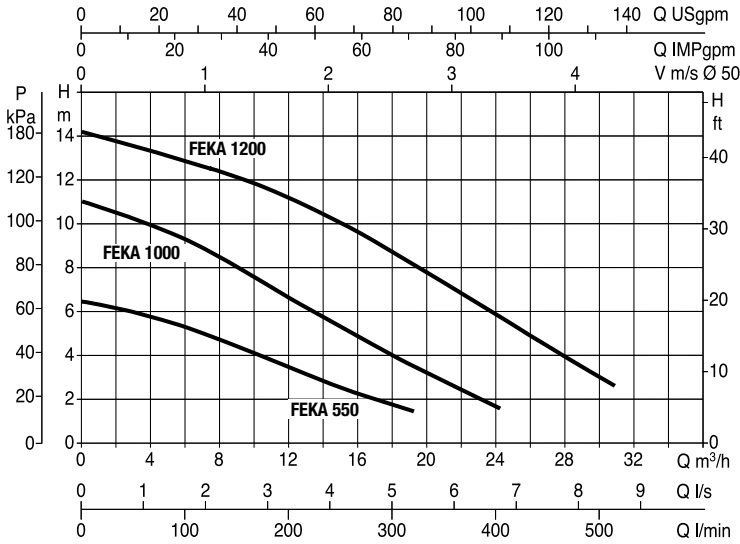

DIMENSIONS AND WEIGHT

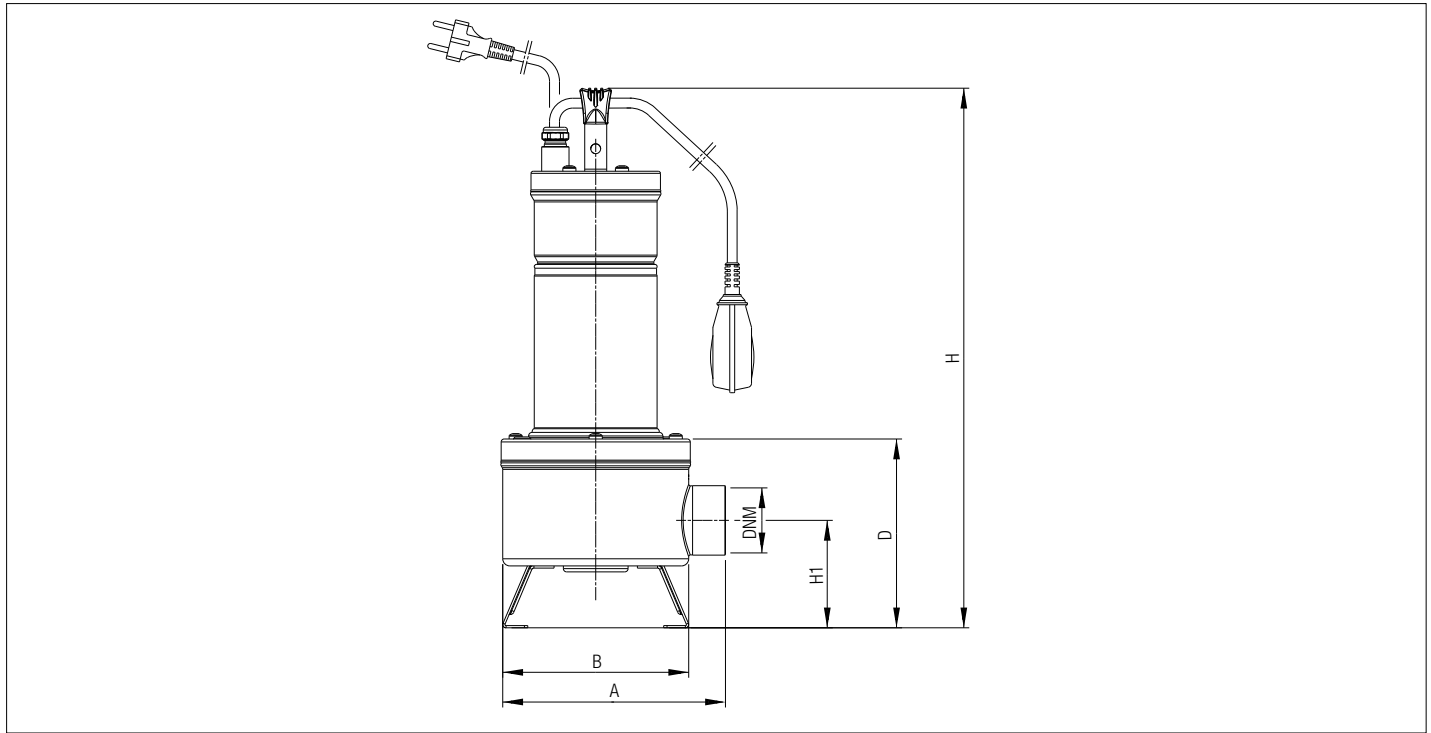

MODEL	A	B	D	H	H1	Ø DNM (NPT)	PACKING DIMENSIONS			CABLE LENGTH (ft)	FREE PASSAGE in	WEIGHT lbs	Q.TY x PALLET
							L/A	L/B	H				
FEKA VS 550	8	6.7	6.8	19.4	3.9	2"	9.4	23.6	9.4	33	2	35.9	24
FEKA VS 1000	8	6.7	6.8	21.1	3.9	2"	9.4	23.6	9.4	33	2	38.6	24
FEKA VS 1200	8	6.7	6.8	21.1	3.9	2"	9.4	23.6	9.4	33	2	45.9	24

DRENAG FX

SUBMERSIBLE PUMPS FOR DRAINAGE OF SANDY WATER AND WATER FROM CONSTRUCTION SITE



Submersible pump for the draining clear water, groundwater or rainwater in commercial building service; the pumps is suitable for applications requiring with high head.

In compliance with CSA Standards C22.2 No.108 - 14, UL Standard No. 778. Suitable for fixed installations with coupling device or mobile if placed directly on the bottom of the tank. The reduced dimensions and the outlet connection both flanged and threaded make it ideal for replacements. Designed for fast maintenance thanks to a construction solution that provides easy access to the main components of the pump. Open impeller and anti-wear rubber disc for use even in the presence of abrasive particles. Double mechanical seal in silicon carbide completely protected in an oil chamber and not in contact with the pumped liquid. Motor shaft in stainless steel AISI 431 for P2 <1.2 kW and AISI 304 for P2 > 1.5 kW, resin cable gland with quick coupling. Single-phase versions with integrated capacitor, available with float for automatic operation (MA) with powers up to 1.5 kW. In the three-phase versions the protection is the responsibility of the user. IECEX (Ex db IIB T4 Gb) available starting from 2022.

Flow rate maximum 136 GPM

Head up to 105 ft

Type of pumped liquid clear water, rainwater and sandy water from construction site

Free passage 0.4"

Nominal speed RPM 3480

Supported liquid temperature (max)

+122°F (+140°F for a short period of time)

+104°F for ATEX version

Flanged and threaded 1" 1/2, DN 32, DN 40

Impeller type open

Class of protection IP 68

Motor insulation class F

Dry run time 10 min

Possible type of installation

mobile if on the floor, fixed on the coupling

Special versions on request

different cable length, different voltage

DRENAG FX



ACCESSORIES
PAG. 159

TECHNICAL DATA

MODEL	CODE	VOLTAGE 60 Hz	P1 MAX W	P2 NOMINAL		In A	DN mm
				kW	HP		
DRENAG FX 15.11 MNA	60194165	120	1.4	1.1	1.5	12.8	DN32 PN16/DN40 PN6
DRENAG FX 15.11 TNA	60194168	208-220	1.2	1.1	1.5	4.23 - 4.4	DN32 PN16/DN40 PN6
DRENAG FX 15.11 MNA	60194114	208-240	1.3	1.1	1.5	5.87 - 6.08	DN32 PN16/DN40 PN6
DRENAG FX 15.11 TNA	60202928	380	1.2	1.1	1.5	2.5	DN32 PN16/DN40 PN6
DRENAG FX 15.11 TNA	60202931	460	1.2	1.1	1.5	2.0	DN32 PN16/DN40 PN6
DRENAG FX 15.11 TNA	60202934	575	1.2	1.1	1.5	1.6	DN32 PN16/DN40 PN6
DRENAG FX 15.15 TNA	60194224	208-220	1.6	1.5	2.0	5.8 - 5.96	DN32 PN16/DN40 PN6
DRENAG FX 15.15 MNA	60194116	208-240	1.8	1.5	2.0	8.16 - 8.17	DN32 PN16/DN40 PN6
DRENAG FX 15.15 TNA	60202929	380	1.6	1.5	2.0	3.4	DN32 PN16/DN40 PN6
DRENAG FX 15.15 TNA	60202932	460	1.6	1.5	2.0	2.7	DN32 PN16/DN40 PN6
DRENAG FX 15.15 TNA	60200935	575	1.6	1.5	2.0	2.2	DN32 PN16/DN40 PN6
DRENAG FX 15.22 TNA	60194285	208-220	2.6	2.2	3.0	8.76 - 9.07	DN32 PN16/DN40 PN6
DRENAG FX 15.22 MNA	60194118	208-240	2.8	2.2	3.0	13 - 12.98	DN32 PN16/DN40 PN6
DRENAG FX 15.22 TNA	60202930	380	2.6	2.2	3.0	5.2	DN32 PN16/DN40 PN6
DRENAG FX 15.22 TNA	60202933	460	2.5	2.2	3.0	3.9	DN32 PN16/DN40 PN6
DRENAG FX 15.22 TNA	60202936	575	2.6	2.2	3.0	3.2	DN32 PN16/DN40 PN6

DRENAG FX

SUBMERSIBLE PUMPS FOR DRAINAGE OF SANDY WATER AND WATER FROM CONSTRUCTION SITE

RANGE PERFORMANCE

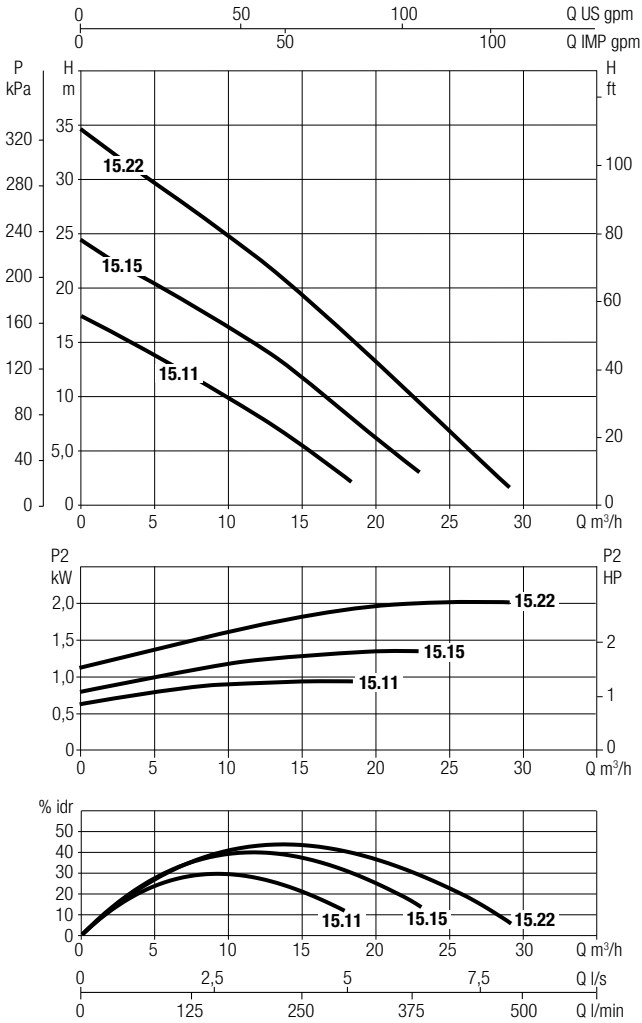

DIMENSIONS

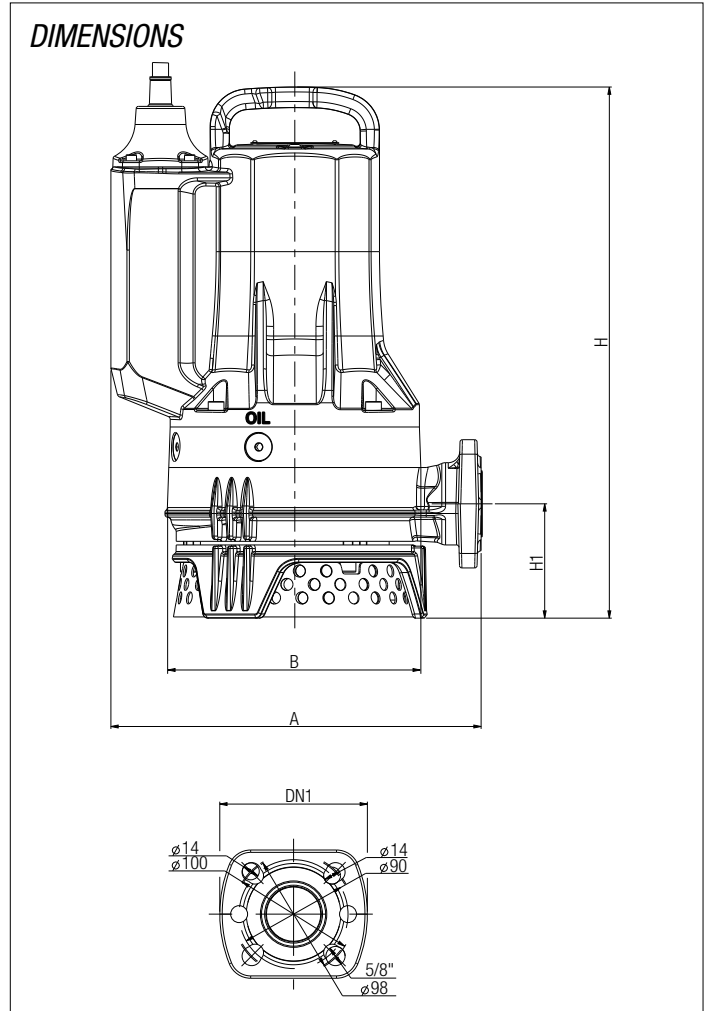

DIMENSIONS AND WEIGHT

MODEL	FREE PASSAGE in	A	B	H		H1	DELIVERY				PACKING DIMENSIONS			WEIGHT lbs
					Ex		NPT	DN1	HOLES	D	L/A	L/B	H	
DRENAG FX 15.11	0.4	12	8.5	16.2	16.9	3.7	Rp 1"1/2	DN32 PN10 / 6 DN40 PN6	4 2	100-90 90	26	14.6	15.7	77.2
DRENAG FX 15.15	0.4	12	8.5	16.6	17.3	3.7	Rp 1"1/2	DN32 PN10 / 6 DN40 PN6	4 2	100-90 90	26	14.6	15.7	83.8
DRENAG FX 15.22	0.4	12	8.5	17.3	18	3.7	Rp 1"1/2	DN32 PN10 / 6 DN40 PN6	4 2	100-90 90	26	14.6	15.7	86

GRINDER FX

SUBMERSIBLE PUMPS WITH CUTTING SYSTEM FOR SEWAGE



Submersible pump with shredder designed for lifting and transferring sewage water in commercial building service.

In compliance with CSA Standards C22.2 No.108 - 14, UL Standard No. 778 which applies to sewage lifting plants containing faecal material in buildings and construction sites.

Suitable for fixed installations with a coupling or mobile if the pumps is placed directly on the bottom of the tank. Thanks to the shredder, the pump is suitable for installations with small diameter pipes or installation that require high pressures. High strength shredding system in AISI 630 steel. Double mechanical seal in silicon carbide completely protected in oil bath and not in contact with the pumped liquid. Motor shaft in AISI 304 stainless steel, resin-fastened cable gland. The reduced overall dimensions and the outlet ports both flanged and threaded make it ideal for replacements. Maintenance is fast due to its design that allows easy access to the pump's main components. Single-phase versions with integrated capacitor, available with float for automatic operation (MA) with powers up to 1.5 kW. In the three-phase versions the protection is the user's responsibility.

IECEX (Ex db IIB T4 Gb) available starting from 2022.

Flow rate maximum 87.2 GPM

Head up to 108 ft

Type of pumped liquid loaded waters with filamentary bodies, paper or textile material

Nominal speed RPM 3480

Supported liquid temperature (max)

+122°F (+140°F for a short period of time)

+104°F for ATEX version

Flanged and threaded from 1"1/2, DN 32, DN 40

Impeller type Grinder

Class of protection IP 68

Motor insulation class F

Dry run time 10 min

Possible type of installation

mobile on the ground or fixed on a coupling device

Special versions on request different cable lengths, different voltages and frequencies

GRINDER FX



ACCESSORIES
PAG. 159

TECHNICAL DATA

MODEL	CODE	VOLTAGE 60 Hz	P1 MAX W	P2 NOMINAL		In A	DN mm
				kW	HP		
GRINDER FX 15.11 MNA	60194123	120	1.4	1.1	1.5	6.12 - 6.23	40
GRINDER FX 15.11 MNA	60194124	208-240	1.4	1.1	1.5	6.12 - 6.23	40
GRINDER FX 15.11 TNA	60194177	208-220	1.2	1.1	1.5	4.4 - 4.55	40
GRINDER FX 15.11 TNA	60202937	380	1.2	1.1	1.5	2.6	40
GRINDER FX 15.11 TNA	60202940	460	1.2	1.1	1.5	2.1	40
GRINDER FX 15.11 TNA	60202943	575	1.2	1.1	1.5	1.6	40
GRINDER FX 15.15 TNA	60194232	208-220	1.7	1.5	2.0	6.2 - 6.29	40
GRINDER FX 15.15 MNA	60194126	208-240	1.8	1.5	2.0	8.4 - 8.26	40
GRINDER FX 15.15 TNA	60202938	380	1.7	1.5	2.0	3.6	40
GRINDER FX 15.15 TNA	60202941	460	1.7	1.5	2.0	2.8	40
GRINDER FX 15.15 TNA	60202944	575	1.6	1.5	2.0	2.2	40
GRINDER FX 15.22 TNA	60194291	208-220	2.6	2.2	3.0	8.94 - 9.07	40
GRINDER FX 15.22 MNA	60194128	208-240	2.7	2.2	3.0	12.65 - 12.67	40
GRINDER FX 15.22 TNA	60202939	380	2.6	2.2	3.0	5.2	40
GRINDER FX 15.22 TNA	60202942	460	2.5	2.2	3.0	4.0	40
GRINDER FX 15.22 TNA	60202945	575	2.5	2.2	3.0	3.1	40

GRINDER FX

SUBMERSIBLE PUMPS WITH CUTTING SYSTEM FOR SEWAGE

RANGE PERFORMANCE

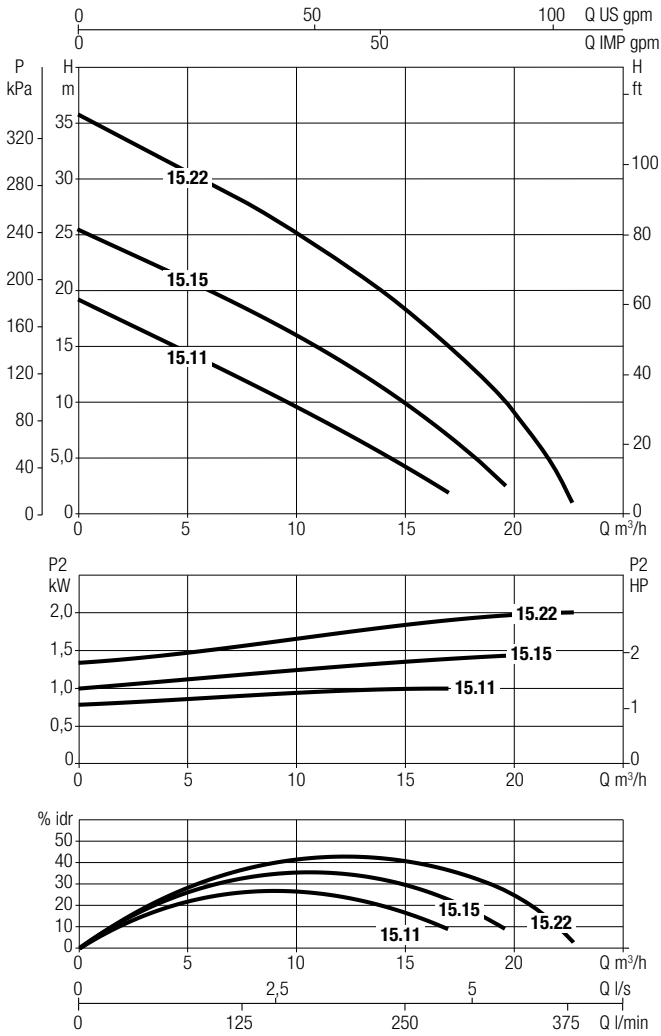

DIMENSIONS

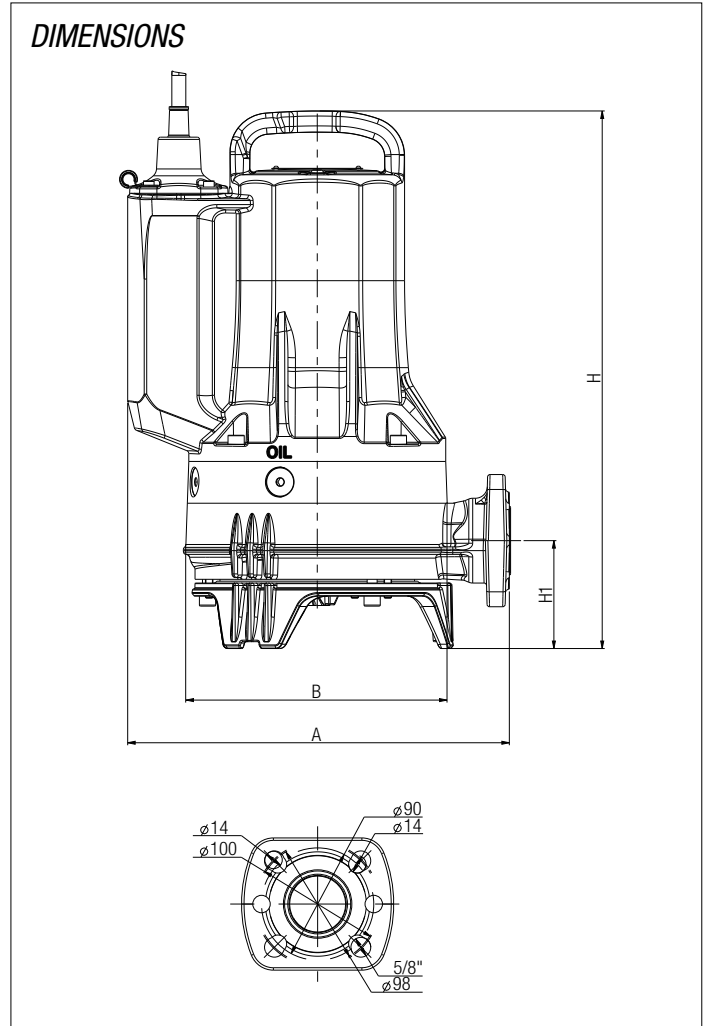

DIMENSIONS AND WEIGHT

MODEL	FREE PASSAGE	A	B	H			DELIVERY				PACKING DIMENSIONS			CABLE LENGTH (ft)	WEIGHT lbs
					Ex	H1	NPT	DN1	HOLES	D	L/A	L/B	H		
GRINDER FX 15.11	-	12	8.5	15.9	16.6	3.4	Rp 1"1/2	DN32 PN10 / 6 DN40 PN6	4 2	100-90 90	26	14.6	15.7	33	77.2
GRINDER FX 15.15	-	12	8.5	16.3	16.9	3.4	Rp 1"1/2	DN32 PN10 / 6 DN40 PN6	4 2	100-90 90	26	14.6	15.7	33	83.8
GRINDER FX 15.22	-	12	8.5	16.9	17.6	3.4	Rp 1"1/2	DN32 PN10 / 6 DN40 PN6	4 2	100-90 90	26	14.6	15.7	33	86

FEKA FXC

SUBMERSIBLE PUMPS FOR EFFLUENT



Submersible pump for the lifting and transferring waste water coming from drains in commercial building service.

In compliance with CSA Standards C22.2 No.108 - 14, UL Standard No. 778. Pump suitable for fixed installations with a coupling or mobile device if placed on the bottom of the tank itself. Channel impeller, 2" free passage and anti-lock system. Suitable for waste water and waste water without the presence of long fibres, rain water and ground water. The pump is suitable for draining environments subject to flooding, when high flow rates are required. Double mechanical silicon carbide seal completely protected in oil chamber and not in contact with the pumped liquid. AISI 304 stainless steel motor shaft, resin-fastened cable gland, quick-coupling power cable.

The small size and both flanged and threaded discharge ports make it ideal for replacements. Maintenance is fast due to its design that allows easy access to the pump's main components.

Single-phase versions with integrated condenser, available with float for automatic operation (MA) with power up to 1.5 kW. In the three-phase versions the protection is the user's responsibility.

IECEX (Ex db IIB T4 Gb) available starting from 2022.

Flow rate maximum 281 GPM

Head up to 59 ft

Type of pumped liquid clear water, rainwater and sandy water from construction site

Free passage 2"

Nominal speed RPM 3480

Supported liquid temperature (max)
+122°F (+140°F for a short period of time)
+104°F for ATEX version

Flanged and threaded from 2", DN 50, DN 65

Impeller type channel

Class of protection IP 68

Motor insulation class F

Dry run time 10 min

Possible type of installation
mobile when on the ground, fixed with coupling

Special versions on request different cable
lengths, different voltages and frequencies

FEKA FXC



ACCESSORIES
PAG. 159

TECHNICAL DATA

MODEL	CODE	VOLTAGE 60 Hz	P1 MAX W	P2 NOMINAL		In A	DN mm
				KW	HP		
FEKA FXC 20.15 MNA	60194096	208-240	1.6	0.8	1.0	7.19 - 7.48	50
FEKA FXC 25.15 MNA	60194106	208-240	1.6	0.8	1.0	7.32 - 7.57	65
FEKA FXC 20.15 TNA	60194098	460	1.4	1.5	2.0	2.46	50
FEKA FXC 25.15 TNA	60194108	460	1.4	1.5	2.0	2.47	65
FEKA FXC 20.15 TNA	60194209	208-220	1.4	1.5	2.0	5.23 - 5.51	50
FEKA FXC 25.15 TNA	60194216	208-220	1.5	1.5	2.0	5.32 - 5.59	65
FEKA FXC 20.15 TNA	60202924	575	1.4	1.5	2.0	1.99	50
FEKA FXC 25.15 TNA	60202925	575	1.5	1.5	2.0	2.01	65
FEKA FXC 20.15 TNA	60202920	380	1.4	1.5	2.0	3.18	50
FEKA FXC 25.15 TNA	60202921	380	1.5	1.5	2.0	3.23	65
FEKA FXC 20.22 MNA	60194147	208-240	2.5	1.1	1.5	11.65 - 12.06	50
FEKA FXC 25.22 MNA	60194157	208-240	2.6	1.1	1.5	12.54 - 12.48	65

FEKA FXC

SUBMERSIBLE PUMPS FOR EFFLUENT

MODEL	CODE	VOLTAGE 60 Hz	P1 MAX W	P2 NOMINAL		In A	DN mm
				kW	HP		
FEKA FXC 20.22 TNA	60194149	460	2.4	2.2	3.0	3.86	50
FEKA FXC 25.22 TNA	60194158	460	2.6	2.2	3.0	4.00	65
FEKA FXC 20.22 TNA	60194273	208-220	2.4	2.2	3.0	8.35 - 8.73	50
FEKA FXC 25.22 TNA	60194279	208-220	2.5	2.2	3.0	8.57 - 8.9	65
FEKA FXC 20.22 TNA	60202922	380	2.4	2.2	3.0	5.04	50
FEKA FXC 25.22 TNA	60202923	380	2.5	2.2	3.0	5.14	65
FEKA FXC 20.22 TNA	60202926	575	2.3	2.2	3.0	2.97	50
FEKA FXC 25.22 TNA	60202927	575	2.4	2.2	3.0	3.06	65

RANGE PERFORMANCE

FEKA FXC 20

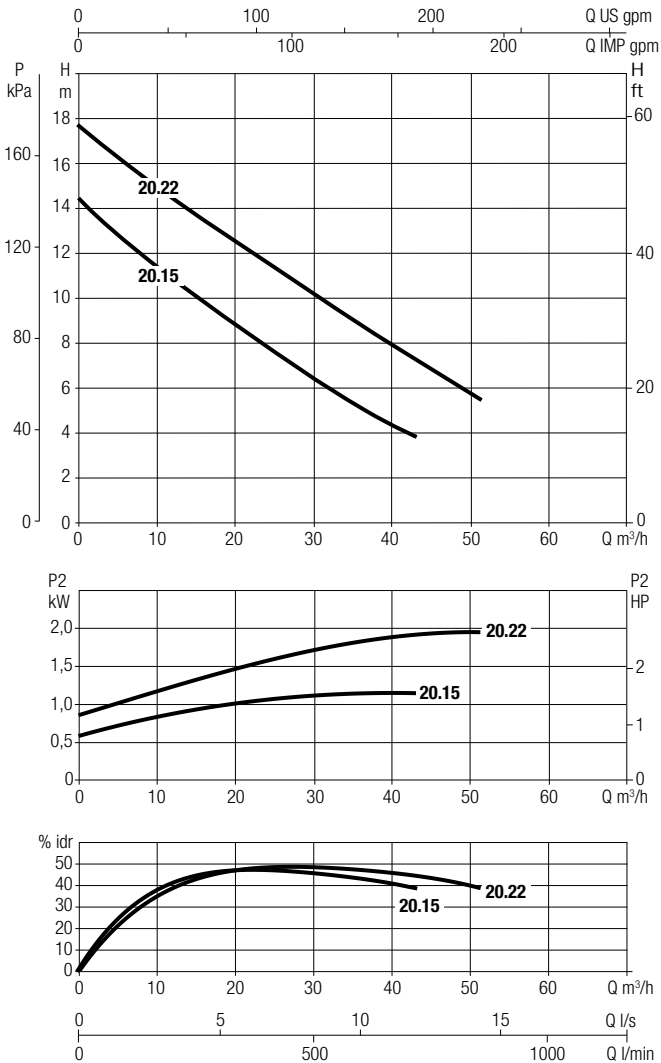

FEKA FXC 25

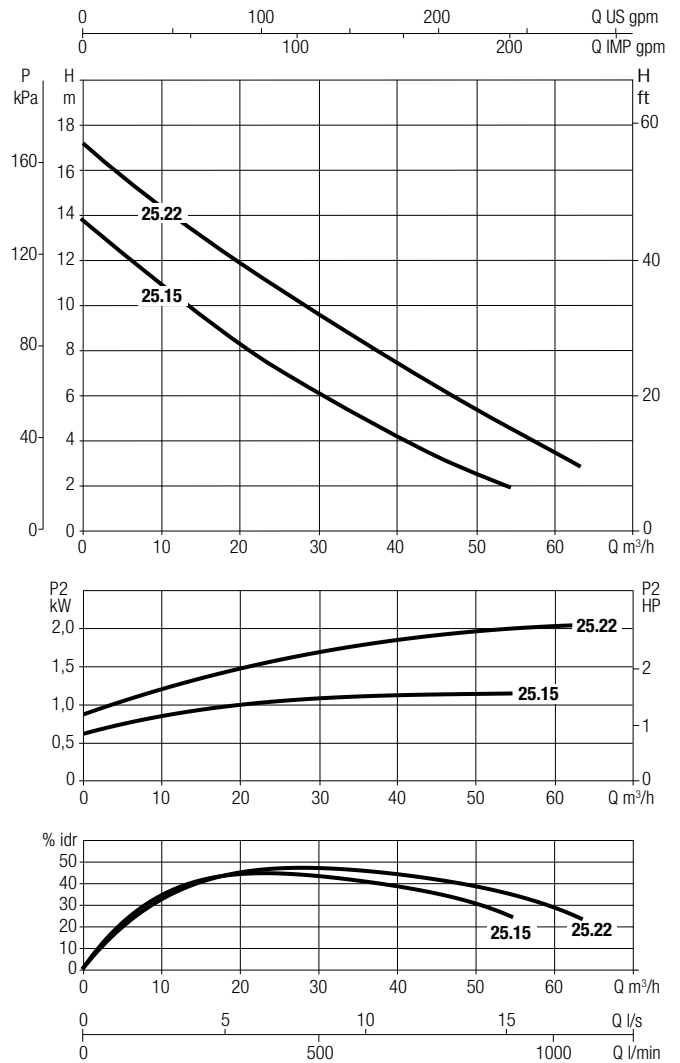

FEKA FXC

SUBMERSIBLE PUMPS FOR EFFLUENT

DIMENSIONS AND WEIGHT

FEKA FXC 20

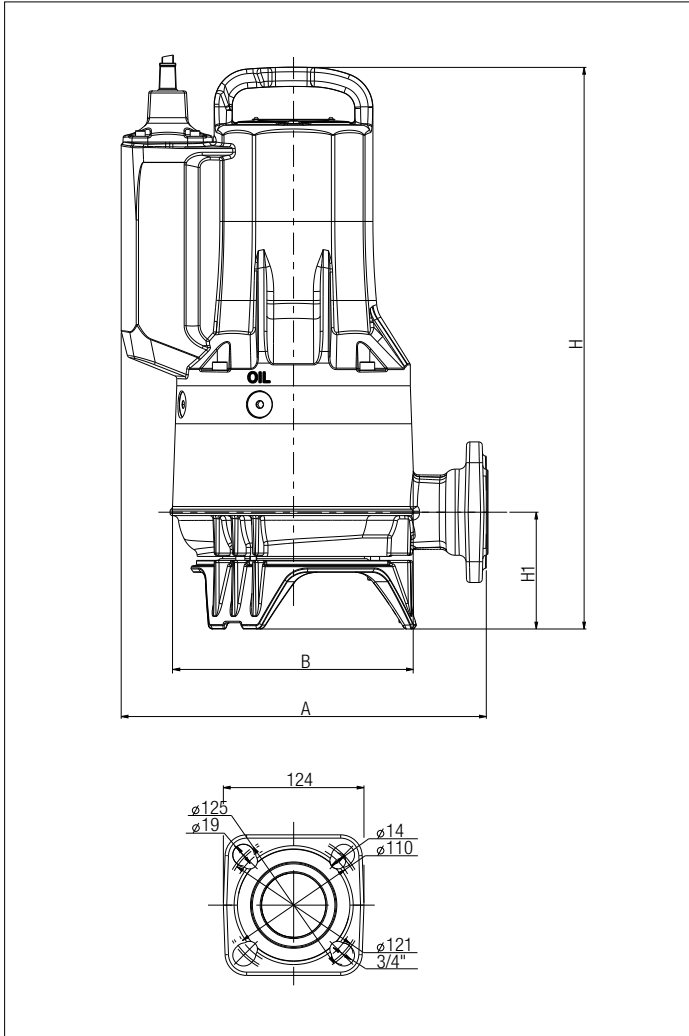

FEKA FXC 25

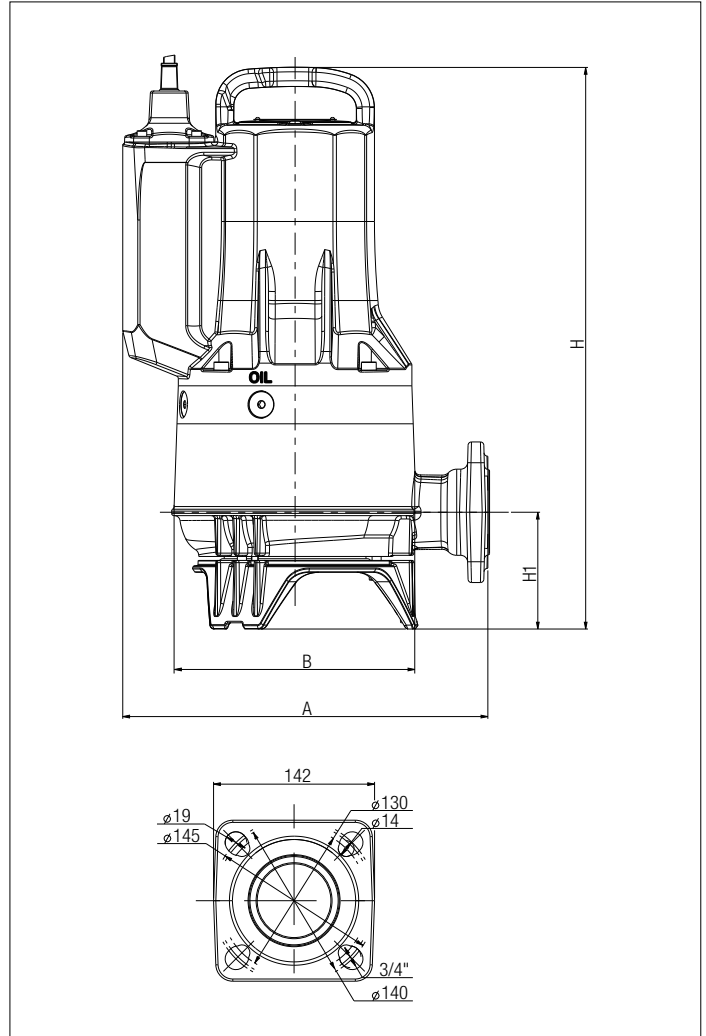

MODEL	FREE PASSAGE in	A	B	H			DELIVERY				PACKING DIMENSIONS			CABLE LENGHT (ft)	WEIGHT lbs
					Ex	H1	NPT	DN1	HOLES	D	L/A	L/B	H		
FEKA FXC 20.15	2	12.7	8.6	18.4	19.5	4.1	Rp 2"	50 PN10/6	4	125-110	26	14.6	15.7	33	92.6
FEKA FXC 20.22	2	12.7	8.6	19.5	20.2	4.1	Rp 2"	50 PN10/6	4	125-110	26	14.6	15.7	33	94.8
FEKA FXC 25.15	2	12.7	8.6	18.8	19.5	4.1	-	65 PN10/6	4	145-130	26	14.6	15.7	33	94.8
FEKA FXC 25.22	2	12.7	8.6	19.5	20.2	4.1	-	65 PN10/6	4	145-130	26	14.6	15.7	33	97

FEKA FXV

SUBMERSIBLE PUMPS FOR SEWAGE



FEKA FXV



ACCESSORIES
PAG. 159

Submersible pump for draining sewage water in commercial building service.

In compliance with CSA Standards C22.2 No.108 - 14, UL Standard No. 778. Suitable for fixed installations with a coupling or mobile if the pump is placed directly on the bottom of the tank. High-performance super Vortex impeller with integral free passage. Double mechanical seal in silicon carbide completely protected in oil chamber and not in contact with the pumped liquid. Motor shaft in AISI 304 stainless steel, resin-fastened cable gland. The reduced overall dimensions and the outlet ports both flanged and threaded make it ideal for replacements. Maintenance is fast due to its design that allows easy access to the pump's main components.

Single-phase versions with integrated capacitor, available with float for automatic operation (MA) with powers up to 1.5 kW. In the three-phase versions the protection is the user's responsibility.

IECEX (Ex db IIB T4 Gb) available starting from 2022.

Flow rate maximum 262.9 GPM

Head up to 61 ft

Type of pumped liquid waters with filamentary bodies, paper or textile material in the presence of domestic or civil waste

Free passage

2" or 2.6" depending on the model

Nominal speed RPM 3480

Supported liquid temperature (max)

+122°F (+140°F for a short period of time)

+104°F for ATEX version

Flanged and threaded from 2", DN 50, DN 65

Impeller type vortex

Class of protection IP 68

Motor insulation class F

Dry run time 10 min

Possible type of installation

mobile when on the ground, fixed with coupling

Special versions on request different cable lengths, different voltages and frequencies

TECHNICAL DATA

MODEL	CODE	VOLTAGE 60 Hz	P1 MAX W	P2 NOMINAL		In A	DN mm
				kW	HP		
FEKA FXV 20.07 MNA	60194130	120	1.4	0.8	1.0	12.85	50
FEKA FXV 20.07 MNA	60194259	208-240	1.4	0.8	1.0	6.04 - 6.23	50
FEKA FXV 20.07 TNA	60194133	208-220	1.2	0.8	1.0	4.34 - 4.5	50
FEKA FXV 20.07 TNA	60194277	380	1.2	0.8	1.0	2.6	50
FEKA FXV 25.07 MNA	60194094	120	1.4	0.8	1.0	13.01	65
FEKA FXV 25.07 MNA	60194104	208-240	1.4	0.8	1.0	6.16 - 6.28	65
FEKA FXV 25.07 TNA	60194097	208-220	1.3	0.8	1.0	4.38 - 4.57	65
FEKA FXV 25.07 TNA	60194107	380	1.3	0.8	1.0	2.64	65
FEKA FXV 20.07 TNA	60202904	460	1.2	0.8	1.0	2.04	50
FEKA FXV 25.07 TNA	60202905	460	1.3	0.8	1.0	2.06	65
FEKA FXV 20.07 TNA	60202912	575	1.2	0.8	1.0	1.6	50
FEKA FXV 25.07 TNA	60202913	575	1.2	0.8	1.0	1.62	65
FEKA FXV 20.11 MNA	60194145	208-240	1.8	1.1	1.5	8.19 - 8.16	50
FEKA FXV 20.11 TNA	60194183	208-220	1.7	1.1	1.5	5.78 - 5.97	50
FEKA FXV 20.11 TNA	60194148	380	1.7	1.1	1.5	3.45	50
FEKA FXV 25.11 MNA	60194155	208-240	1.8	1.1	1.5	8.25 - 8.22	65

FEKA FXV

SUBMERSIBLE PUMPS FOR SEWAGE

TECHNICAL DATA

MODEL	CODE	VOLTAGE 60 Hz	P1 MAX W	P2 NOMINAL		In A	DN mm
				kW	HP		
FEKA FXV 25.11 TNA	60194199	208-220	1.7	1.1	1.5	5.84 - 6.04	65
FEKA FXV 25.11 TNA	60194159	380	1.7	1.1	1.5	3.49	65
FEKA FXV 20.11 TNA	60202906	460	1.6	1.1	1.5	2.67	50
FEKA FXV 25.11 TNA	60202907	460	1.6	1.1	1.5	2.71	65
FEKA FXV 20.11 TNA	60202914	575	1.6	1.1	1.5	2.15	50
FEKA FXV 25.11 TNA	60202915	575	1.6	1.1	1.5	2.15	65
FEKA FXV 25.15 MNA	60194174	208-240	2.6	1.5	2.0	11.99 - 12.24	65
FEKA FXV 25.15 TNA	60194239	208-220	2.4	1.5	2.0	8.23 - 8.59	65
FEKA FXV 25.15 TNA	60194215	380	2.4	1.5	2.0	4.96	65
FEKA FXV 20.15 MNA	60202895	208-240	2.5	1.5	2.0	11.92 - 12.15	50
FEKA FXV 20.15 TNA	60194246	208-220	2.4	1.5	2.0	8.21 - 8.5	50
FEKA FXV 20.15 TNA	60194258	380	2.4	1.5	2.0	4.74 - 4.91	50
FEKA FXV 25.15 TNA	60202908	460	2.4	1.5	2.0	3.81	65
FEKA FXV 20.15 TNA	60202909	460	2.4	1.5	2.0	3.81	50
FEKA FXV 25.15 TNA	60202916	575	2.3	1.5	2.0	2.94	65
FEKA FXV 20.15 TNA	60202917	575	2.3	1.5	2.0	2.93	50
FEKA FXV 20.22 MNA	60202897	208-240	3.0	2.2	3.0	13.95 - 13.69	50
FEKA FXV 25.22 MNA	60202899	208-240	2.9	2.2	3.0	13.65 - 13.61	65
FEKA FXV 20.22 TNA	60202900	380	2.8	2.2	3.0	5.47	50
FEKA FXV 20.22 TNA	60202901	208-220	2.8	2.2	3.0	9.32 - 9.47	50
FEKA FXV 25.22 TNA	60202902	208-220	2.8	2.2	3.0	9.23 - 9.59	65
FEKA FXV 25.22 TNA	60202903	380	2.8	2.2	3.0	5.54	65
FEKA FXV 20.22 TNA	60202910	460	2.8	2.2	3.0	4.34	50
FEKA FXV 25.22 TNA	60202911	460	2.9	2.2	3.0	4.38	65
FEKA FXV 20.22 TNA	60202918	575	2.7	2.2	3.0	3.31	50
FEKA FXV 25.22 TNA	60202919	575	2.7	2.2	3.0	3.36	65

FEKA FXV

SUBMERSIBLE PUMPS FOR SEWAGE

RANGE PERFORMANCE

FEKA FXV 20

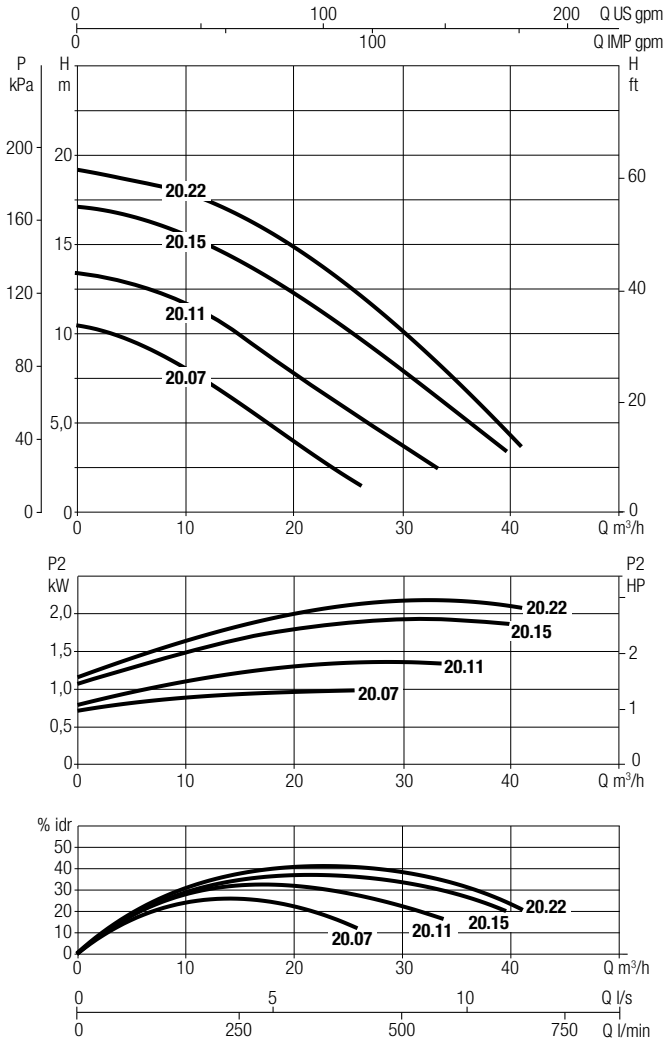

FEKA FXV 25

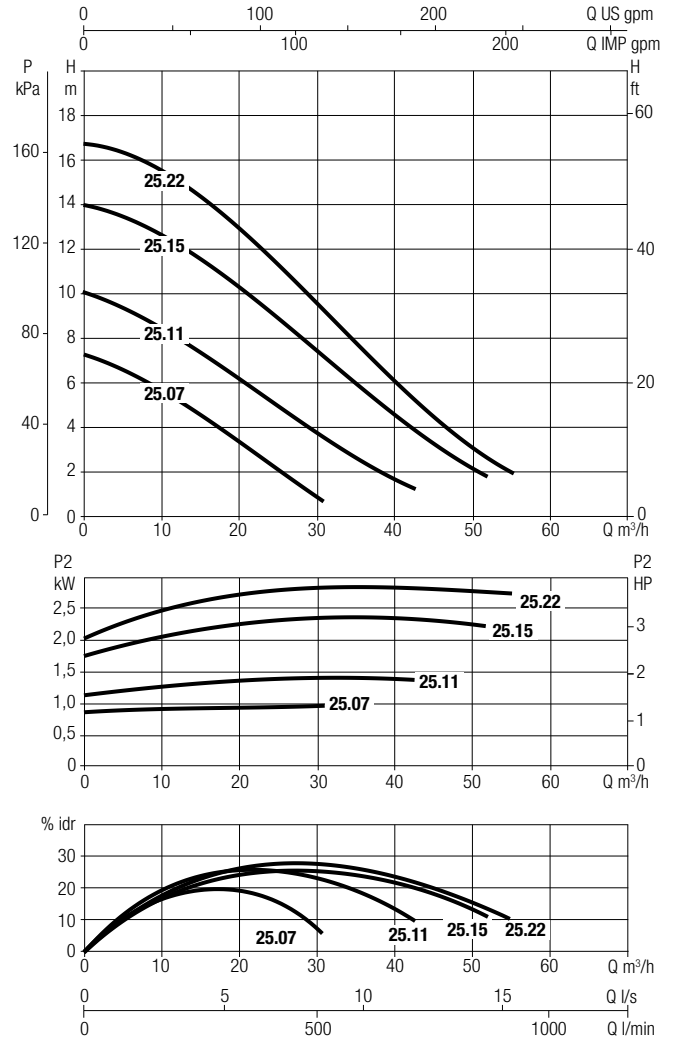

FEKA FXV

SUBMERSIBLE PUMPS FOR SEWAGE

DIMENSIONS AND WEIGHT

FEKA FXV 20

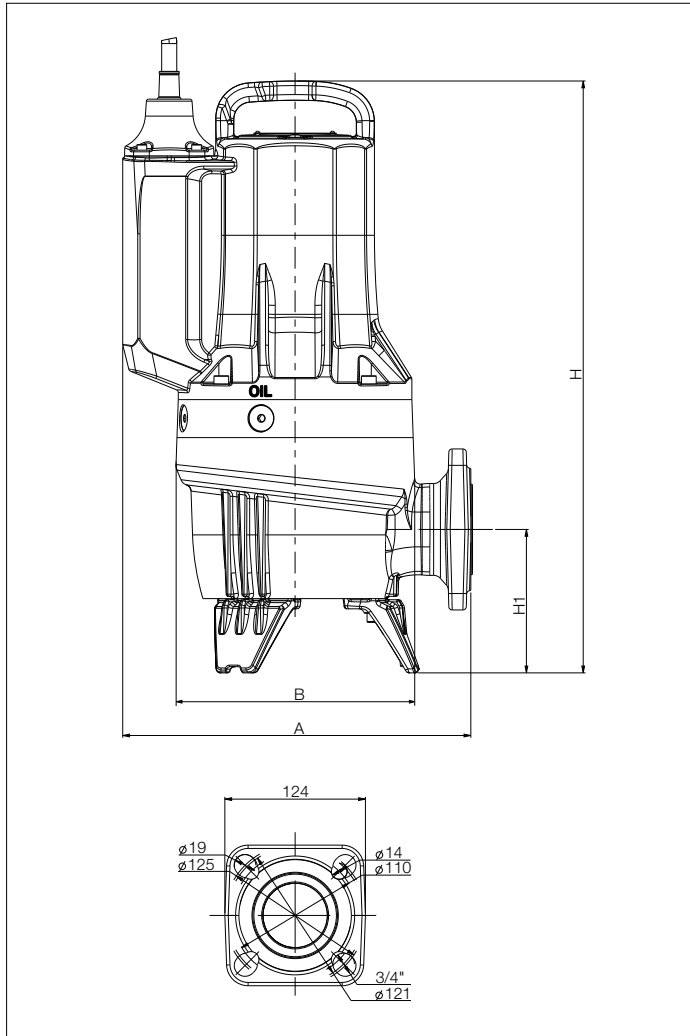

FEKA FXV 25

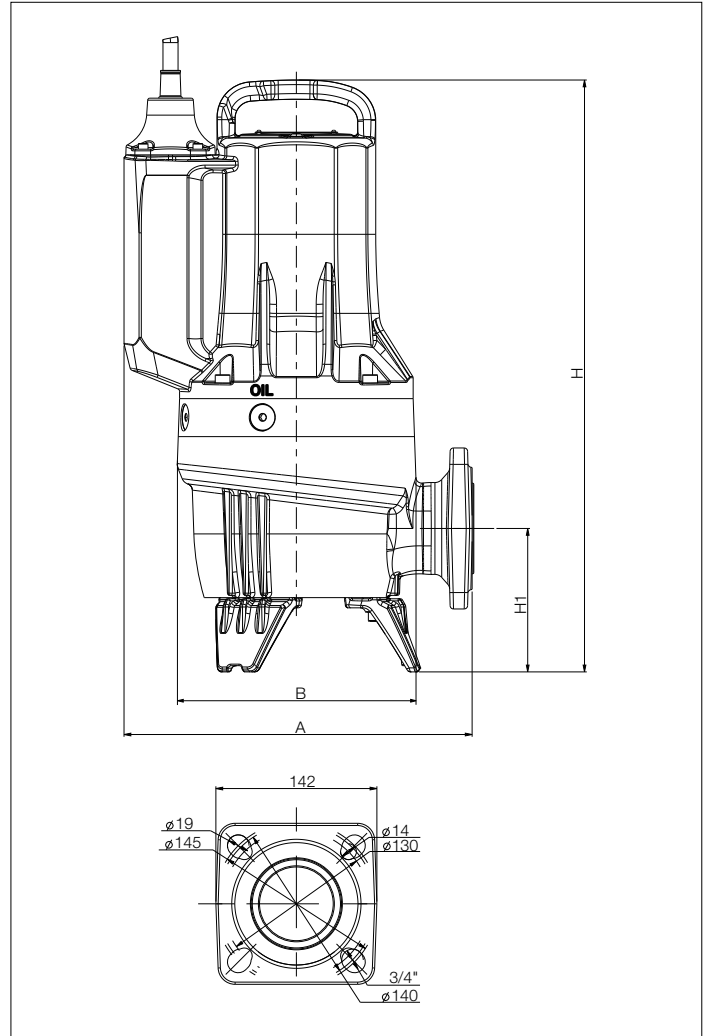

MODEL	FREE PASSAGE in	A	B	H		H1	DELIVERY				PACKING DIMENSIONS			CABLE LENGTH (ft)	WEIGHT lbs
					Ex		NPT	DN1	HOLES	D	L/A	L/B	H		
FEKA FXV 20.07	2	12.1	8.3	18.3	18.3	4.1	Rp 2"	50 PN10/6	4	125-110	26	14.6	15.7	33	77.2
FEKA FXV 20.11	2	12.1	8.3	18.3	19	4.1	Rp 2"	50 PN10/6	4	125-110	26	14.6	15.7	33	77.2
FEKA FXV 20.15 MA	2	12.1	8.3	18.3	-	4.1	Rp 2"	50 PN10/6	4	125-110	26	14.6	15.7	33	86
FEKA FXV 20.15 MNA-TNA	2	12.1	8.3	18.7	19.4	4.1	Rp 2"	50 PN10/6	4	125-110	26	14.6	15.7	33	86
FEKA FXV 20.22	2	12.1	8.3	19.4	20	4.1	Rp 2"	50 PN10/6	4	125-110	26	14.6	15.7	33	88.2
FEKA FXV 25.07	2.6	12.1	8.3	19.8	20.4	4.9	-	65 PN10/6	4	145-130	26	14.6	15.7	33	79.4
FEKA FXV 25.11	2.6	12.1	8.3	19.8	20.4	4.9	-	65 PN10/6	4	145-130	26	14.6	15.7	33	81.6
FEKA FXV 25.15	2.6	12.1	8.3	20.6	21.2	5	-	65 PN10/6	4	145-130	26	14.6	15.7	33	94.8
FEKA FXV 25.22	2.6	12.1	8.3	20.6	21.2	5	-	65 PN10/6	4	145-130	26	14.6	15.7	33	90.4
FEKA FXV 25.07.4	2.6	13.2	10	21.5	21.5	5.2	-	65 PN10/6	4	145-130	26	14.6	15.7	33	99.2
FEKA FXV 25.22.4	2.6	13.2	10	21.5	21.5	5.2	-	65 PN10/6	4	145-130	26	14.6	15.7	33	105.8

ACCESSORIES SUMP & SEWAGE



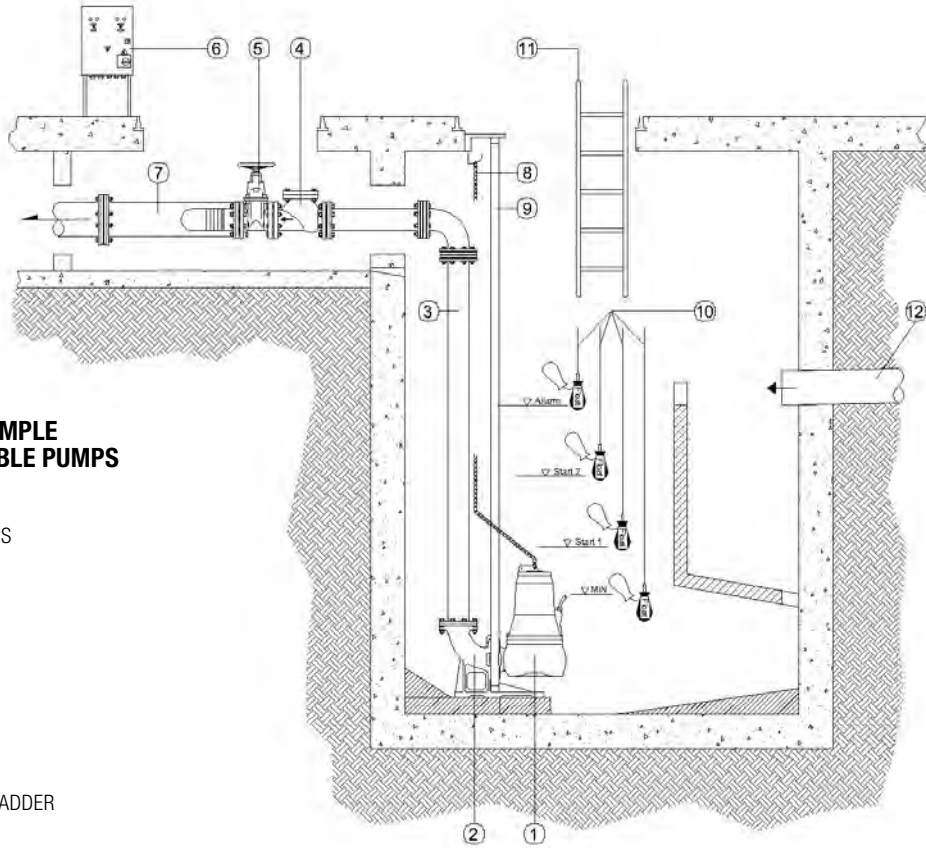

PUMPING STATIONS ACCESSORIES





INSTALLATION EXAMPLE OF TWO SUBMERSIBLE PUMPS

KEY:



- 1 SUBMERSIBLE PUMPS
- 2 BASE ELBOW
- 3 DISCHARGE PIPE
- 4 BALL CHECK VALVE
- 5 GATE VALVE
- 6 CONTROL PANEL
- 7 MANIFOLD
- 8 LIFTING CHAIN
- 9 GUIDE RAILS
- 10 FLOAT SWITCHES
- 11 SUMP INSPECTION LADDER
- 12 INLET PIPE

FLOATS	NOVA / FEKA DRENAG	FEKA VS	FX	DESCRIPTION	CODE	
	•	•	•	FLOAT SWITCH	16 FT	159260030
					33 FT	159260040
					49 FT	159260050
					66 FT	159260070
	•	•	•	FLOAT SWITCH - ATEX	33 FT	60119025
					66 FT	002718001
	•	•	•	FLOAT SWITCH COUNTERWEIGHT - 0.7 LBS		002910501
		•		FLOAT CABLE STOP KIT FOR FEKA VS		147121370

PUMPING STATIONS ACCESSORIES



LIFTING DEVICES	NOVA / FEKA / DRENAG	FEKA VS	FX	DESCRIPTION	CODE
		•		DSD2 - DAB FEKA 550->1200 NPT	60204318
		•		ANTIROTATION BRACKET FOR FEKA VS	147121490

GUIDE TUBES NOT INCLUDED

COUPLING UNIT	NOVA / FEKA / DRENAG	FEKA VS	FX	DESCRIPTION	CODE
			•	DA-050 HORIZONTAL COUPLING UNIT DN32 DN40 DN50	60195865
			•	DA-065 HORIZONTAL COUPLING UNIT DN65	60170310
			•	DA-V65 COUPLING UNIT DN65	60167993

CHAIN KITS	NOVA / FEKA / DRENAG	FEKA VS	FX	DESCRIPTION	CODE
	•	•	•	KIT CHAIN W/SHACKLE 10 FT A316 MAX 330.7 LBS	60171183
				KIT CHAIN W/SHACKLE 10 FT A316 MAX 771.6 LBS	60178908
				KIT CHAIN W/SHACKLE 10 FT A316 MAX 1543.2 LBS	60171189

PUMPING STATIONS ACCESSORIES



ADAPTERS	NOVA / FEKA DRENAG	FEKA VS	FX	DESCRIPTION	CODE
			•	COUPLING SYSTEM ADAPTOR FX GRINDER – FEKA DN32 DN40 DN50	60196199
			•	COUPLING SYSTEM ADAPTOR FX - FLYGT DN50	60196203
			•	KIT ELBOW 90° 2" NPT FX	60204319
			•	KIT ELBOW 90° 1"1/2 NPT FX	60204320

KIT FLANGE	NOVA / FEKA DRENAG	FEKA VS	FX	DESCRIPTION	CODE
			•	KIT FLANGE DN 65 PN16 UNI 2254	60172458

BALL NON-RETURN VALVES	NOVA / FEKA DRENAG	FEKA VS	FX	DESCRIPTION	CODE
		•	•	DN50 NON RETURN VALVE (BALL)	60160629
		•	•	DN65 NON RETURN VALVE (BALL)	60160630

PUMPING STATIONS ACCESSORIES

GATE VALVES	NOVA / FEKA DRENAG	FEKA VS	FX	DESCRIPTION	CODE
		•	•	GATE VALVE FLANGED DN 50	60163811
		•	•	GATE VALVE FLANGED DN 65	60163812

ALARMS AND CONTROL	NOVA / FEKA DRENAG	FEKA VS	FX	DESCRIPTION	CODE
	•	•	•	AS 1 CONTROL WITH ALARM DEVICE	108310000
	•	•	•	AUDIBLE ALARM - 230 V - 60HZ	002789002
				AUDIBLE ALARM - 24 V - 60 HZ	002789000
	•	•	•	FLASHING 230V 5W 50/60 HZ	60169271

TRASDUCERS	NOVA / FEKA DRENAG	FEKA VS	FX	DESCRIPTION	CODE
	•	•	•	PRESSURE TRASDUCER 0-16 FT CABLE 66 FT FOR EBOX	60114675



EVOSTA 2 - EVOSTA 2D - EVOSTA 2 55 SAN
WET ROTOR ELECTRONIC CIRCULATORS

PAGE 166



EVOPLUS
CIRCULATORS FOR HEATING AND AIR-CONDITIONING SYSTEMS

PAGE 177



EVOPLUS SMALL
ELECTRONIC CIRCULATORS FOR SMALL COMMUNITY HEATING

PAG. 168

ACCESSORIES

PAG. 205

EVOSTA 2

ELECTRONIC CIRCULATORS FOR DOMESTIC HEATING SYSTEMS - SINGLE, WITH UNIONS



EVOSTA 2



Evosta 2 by DAB is a wet rotor electronic circulator designed for the recirculation of water in domestic and residential heating and air conditioning systems.

Evosta 2 has a permanent magnet synchronous motor and inverter electronics that automatically adapt performance to system requirements, ensuring energy savings and protection from hammering effects.

With its compact size and all-round performance, it's the perfect replacement of old three-speed circulators. It combines the strength of the mechanical circulator with the benefits of the electronic one. Its configuration is very simple: a sequential button can be used to scroll through the nine operating modes, three with proportional pressure, three with constant pressure and three with constant speed. All the models have a breather plug and allow manual release of the motor shaft. Threaded suction and delivery ports. Technopolymer impeller. Cataphoretic paint coated cast iron body, stainless steel motor casing. Water resistant electronics with IPX5 protection class.

Operating range

0.8 - 15.1 gpm with head up to 18 ft

Pumped liquid temperature range

from +14 °F to +230 °F

Working pressure 145 psi

Protection class: IP X5. (NEMA 4X) Protected against jets of water

Insulation class F

Installation with horizontal motor axis

Standard power input

single-phase 1 x 110-127V~ 60 Hz

Pumped liquid clean, free of solids and mineral oils, non-viscous, chemically neutral, with properties similar to water (glycol max 30%)

PUMP BODY Pump body in cast iron with cathaphoresis treatment EVOSTA2 SAN version with Stainless Steel

TECHNICAL DATA

MODEL	CODE	CENTRE DISTANCE	FLANGE	POWER INPUT 60 Hz	P1 MAX W	In A	EEI	MINIMUM SUCTION PRESSURE	
								t°	194 °F
EVOSTA 2 55 110-127V 60Hz	60192406	6 3/8"	OVAL 2 BOLT	1 x 110-127V~	4 41	0.064 0.61	EEI ≤ 0.23	ft.c.w.	32.8
EVOSTA 2D 55 110-127V 60Hz	60192407	6 3/8"	OVAL 2 BOLT	1 x 110-127V~	4 41	0.064 0.61	EEI ≤ 0.23	ft.c.w.	32.8
EVOSTA 2 55 SAN 110-127V 60Hz	60193156	6 3/8"	OVAL 2 BOLT	1 x 110-127V~	4 41	0.064 0.61	EEI ≤ 0.23	ft.c.w.	32.8

RANGE PERFORMANCE

MODEL	HYDRAULIC DATA									
	Q=GPM	0	2	4	6	8	10	12	14	15.12
EVOSTA 2 RANGE	H (ft)	17.92	17.85	17.81	14.38	11.98	9.42	7.01	4.79	3.34

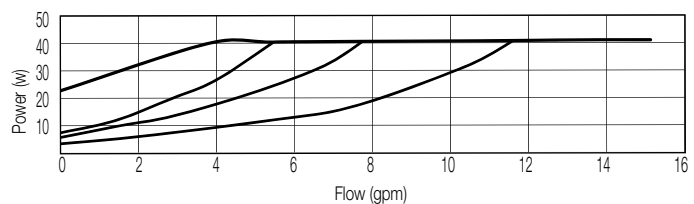
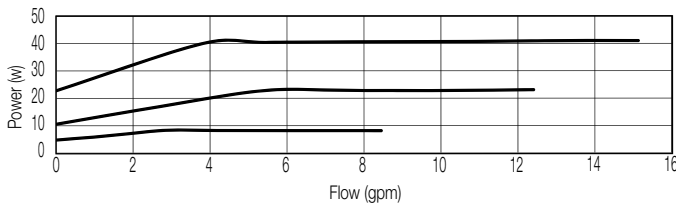
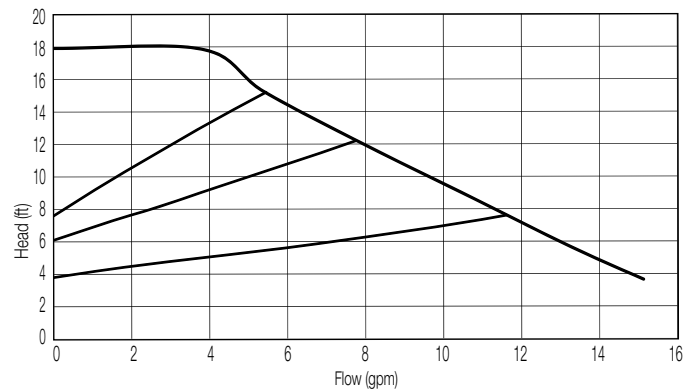
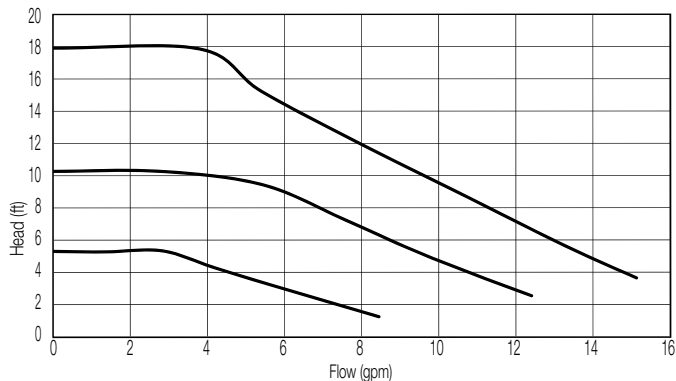

CONSTANT SPEED

PROPORTIONAL PRESSURE



EVOSTA 2

ELECTRONIC CIRCULATORS FOR DOMESTIC HEATING SYSTEMS - SINGLE, WITH UNIONS

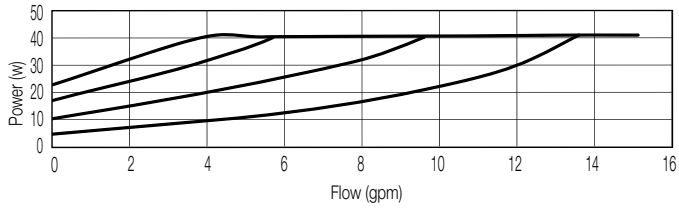
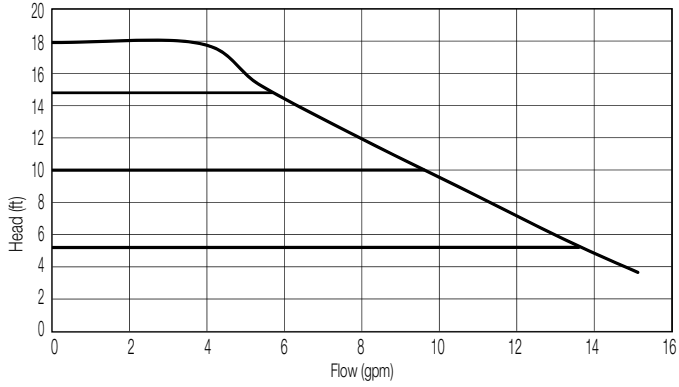

CONSTANT PRESSURE

Curve tolerance according to ISO 9906.

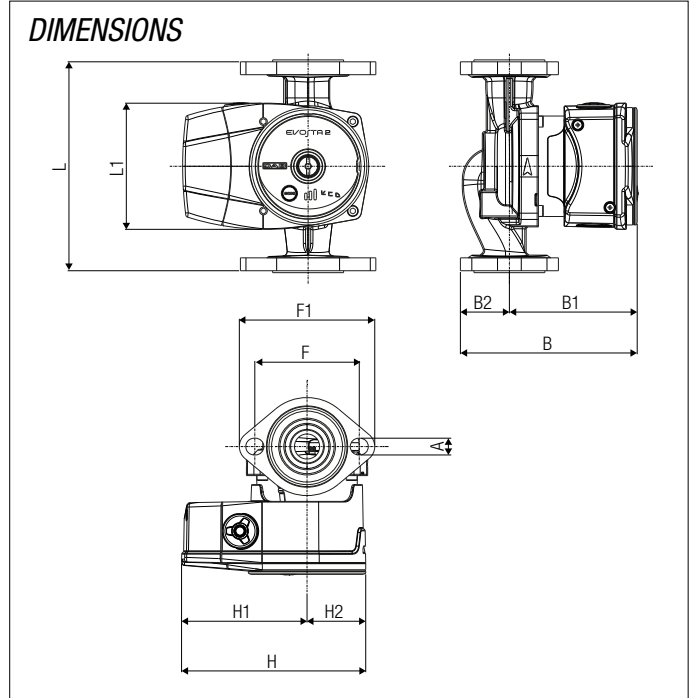

DIMENSIONS AND WEIGHTS

MODEL	L	L1	B	B1	B2	H	H1	H2	A	F	F1	PACKING DIMENSIONS			VOLUME ft ³	WEIGHT lbs
												L	B	H		
EVOSTA 2 RANGE	6 ³ / ₈ "	5 ⁵⁵ / ₆₄ "	5 ²⁵ / ₆₄ "	3 ⁵⁷ / ₆₄ "	1 ¹ / ₂ "	5 ⁵ / ₈ "	3 ¹³ / ₁₆ "	1 ¹³ / ₆₄ "	3 ³ / ₆₄ "	3 ³ / ₁₆ "	4 ⁹ / ₆₄ "	5 ²³ / ₆₄ "	7 ¹ / ₄ "	6 ¹⁷ / ₃₂ "	0.1467	5.37

EVOPLUS SMALL

ELECTRONIC CIRCULATORS FOR SMALL COMMUNITY HEATING



EVOPLUS SMALL electronic circulators can be used in heating, ventilation and air conditioning systems for residential and commercial buildings. In all correctly sized installations, the electronically controlled wet rotor pumps constantly ensure sufficient power and, simultaneously, lower noise emissions, greater comfort and a significant reduction in running costs. All models fitted with flanged pump body are available in both single and the twin versions. The user interface is easy to use and easy to understand.

Circulator protection rate IP 44

Insulation class F

Standard voltage

single-phase 220/240V, 50/60Hz

In accordance with European standards

EN 61800-3 - EN 60335-1 - EN 60335-2-51

Operating range

from 8.8 to 52.8 GPM with head up to 36 ft

Liquid Temperature range from 14°F to 230°F

Pumped liquid clean, free from solids and mineral oils, not viscous, chemically neutral, close to the properties of water (max. glycol contents 30%)

Maximum working pressure 232 psi

Standard flanging the single version is available with 1 1/2" and 2" threaded ports and with flanged ports DN 32 and DN 40, PN 6 / PN 10 / PN 16

The twin version is available with flanged pump body DN 32 and DN 40, PN 6 / PN 10 / PN 16

Installation with horizontal motor shaft

EVOPLUS
SMALL



PENDING APPROVAL



PAG. 5

ACCESSORIES
PAG. 205

TECHNICAL DATA - SINGLE WITH FLANGES

MODEL	CODE	CENTRE DISTANCE in	COUNTERFLANG. ON REQUEST	ELECTRICAL DATA			EEI PART 2	
				VOLTAGE 50/60 Hz	P1 MAX W	In A		
DN 32	EVOPLUS B 40/220.32 M	60150946	8.7	DN32 PN 6	220/240 V	68	0.55	EEI ≤ 0.20
	EVOPLUS B 60/220.32 M	60150947	8.7	DN32 PN 6	220/240 V	100	0.75	EEI ≤ 0.20
	EVOPLUS B 80/220.32 M	60150948	8.7	DN32 PN 6	220/240 V	132	0.97	EEI ≤ 0.20
	EVOPLUS B 110/220.32 M	60150949	8.7	DN32 PN 6	220/240 V	180	1.3	EEI ≤ 0.20
DN 40	EVOPLUS B 40/250.40 M	60150950	9.8	DN40 PN 10	220/240 V	70	0.55	EEI ≤ 0.20
	EVOPLUS B 60/250.40 M	60150951	9.8	DN40 PN 10	220/240 V	100	0.75	EEI ≤ 0.20
	EVOPLUS B 80/250.40 M	60150952	9.8	DN40 PN 10	220/240 V	132	0.97	EEI ≤ 0.20
	EVOPLUS B 110/250.40 M	60150953	9.8	DN40 PN 10	220/240 V	180	1.3	EEI ≤ 0.20

TECHNICAL DATA - TWIN FLANGED

MODEL	CODE	CENTRE DISTANCE in	COUNTERFLANG. ON REQUEST	ELECTRICAL DATA			EEI PART 2	
				VOLTAGE 50/60 Hz	P1 MAX W	In A		
DN 32	EVOPLUS D 40/220.32 M	60150954	8.7	DN32 PN 6	220/240 V	70	0.55	EEI ≤ 0.23
	EVOPLUS D 60/220.32 M	60150955	8.7	DN32 PN 6	220/240 V	95	0.75	EEI ≤ 0.23
	EVOPLUS D 80/220.32 M	60150956	8.7	DN32 PN 6	220/240 V	130	0.95	EEI ≤ 0.23
	EVOPLUS D 110/220.32 M	60150957	8.7	DN32 PN 6	220/240 V	190	1.3	EEI ≤ 0.23
DN 40	EVOPLUS D 40/250.40 M	60150958	9.8	DN40 PN 10	220/240 V	75	0.55	EEI ≤ 0.22
	EVOPLUS D 60/250.40 M	60150959	9.8	DN40 PN 10	220/240 V	100	0.75	EEI ≤ 0.22
	EVOPLUS D 80/250.40 M	60150960	9.8	DN40 PN 10	220/240 V	135	0.95	EEI ≤ 0.22
	EVOPLUS D 110/250.40 M	60150961	9.8	DN40 PN 10	220/240 V	190	1.3	EEI ≤ 0.22

EVOPLUS SMALL

ELECTRONIC CIRCULATORS FOR SMALL COMMUNITY HEATING

RANGE PERFORMANCE

MODEL	HYDRAULIC DATA							
	Q= GPM	0	10.6	13.2	18.5	23.8	31.7	42.2
EVOPLUS B 40/220.32 M	H (ft)	14	14	14	11	8	4	
EVOPLUS B 60/220.32 M		20	20	18	15	12	7	
EVOPLUS B 80/220.32 M		26	26	24	20	16	11	
EVOPLUS B 110/220.32 M		37	34	31	27	22	16	9
EVOPLUS B 40/250.40 M		14	14	14	11	8	4	
EVOPLUS B 60/250.40 M		20	20	18	15	12	7	
EVOPLUS B 80/250.40 M		26	26	24	20	16	11	
EVOPLUS B 110/250.40 M		37	34	31	27	22	16	9
EVOPLUS D 40/220.32 M		14	14	14	11	8	4	
EVOPLUS D 60/220.32 M		20	20	18	15	12	7	
EVOPLUS D 80/220.32 M		26	26	24	20	16	11	
EVOPLUS D 110/220.32 M		37	34	31	27	22	16	9
EVOPLUS D 40/250.40 M		14	14	14	11	8	4	
EVOPLUS D 60/250.40 M		20	20	18	15	12	7	
EVOPLUS D 80/250.40 M		26	26	24	20	16	11	
EVOPLUS D 110/250.40 M		37	34	31	27	22	16	9

EVOPLUS SMALL

ELECTRONIC CIRCULATORS FOR SMALL COMMUNITY HEATING

EVOPLUS B 40/220.32 M

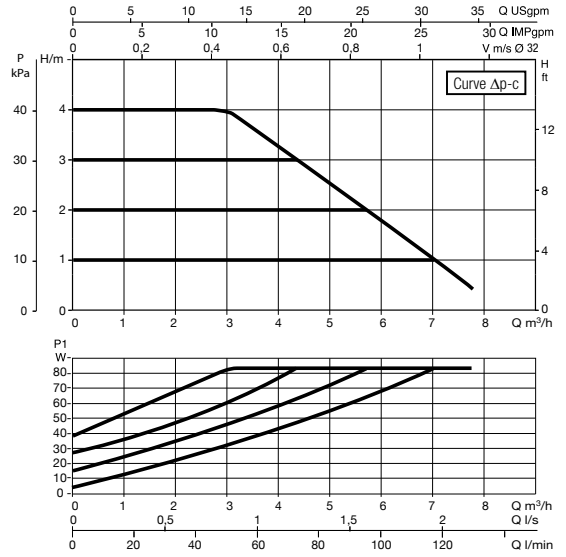
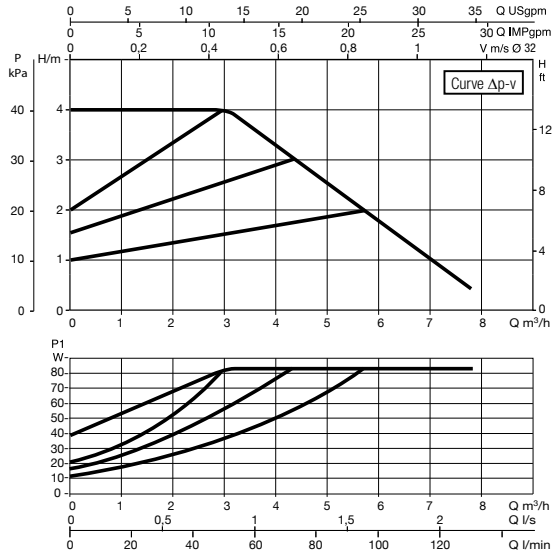

EVOPLUS B 60/220.32 M

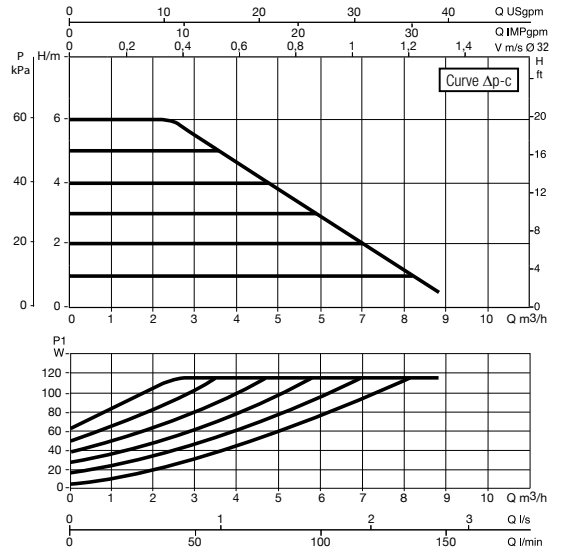
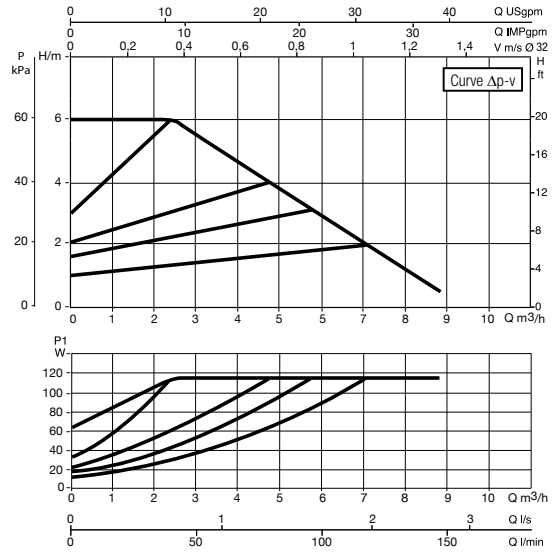

EVOPLUS B 80/220.32 M

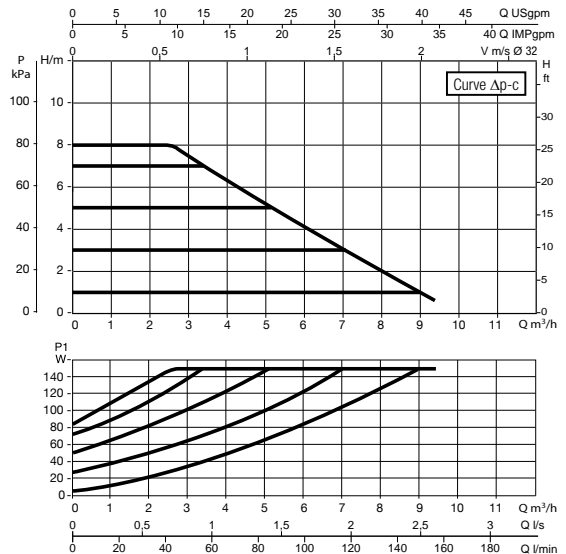
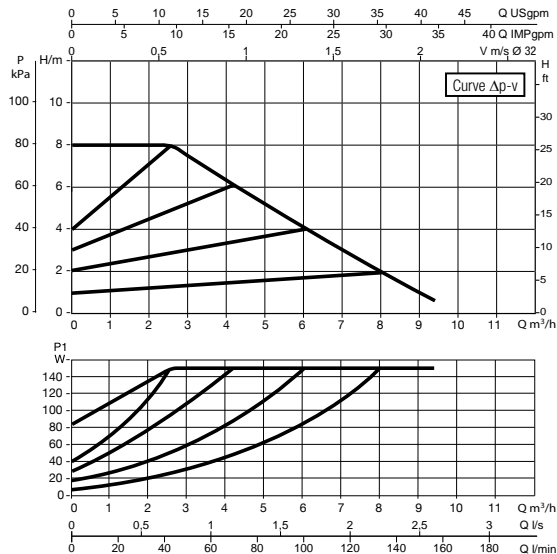

Curve tolerance according to ISO 9906.

HVAC

EVOPLUS SMALL

ELECTRONIC CIRCULATORS FOR SMALL COMMUNITY HEATING

EVOPLUS B 110/220.32 M

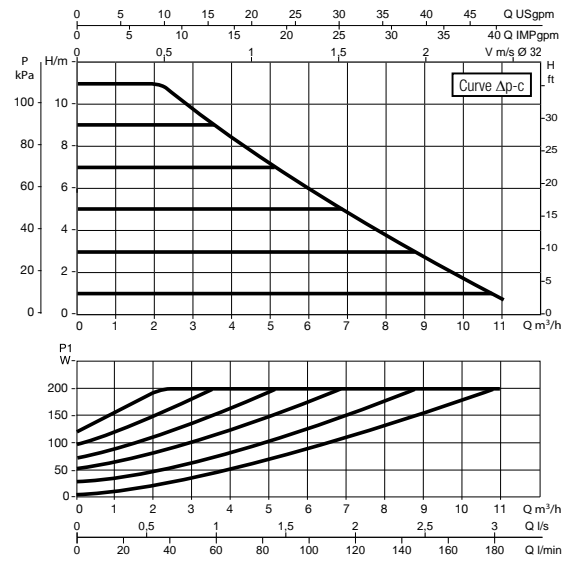
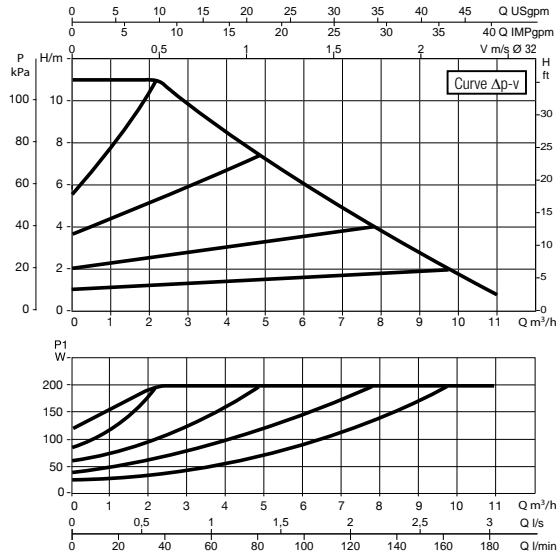

EVOPLUS B 40/250.40 M

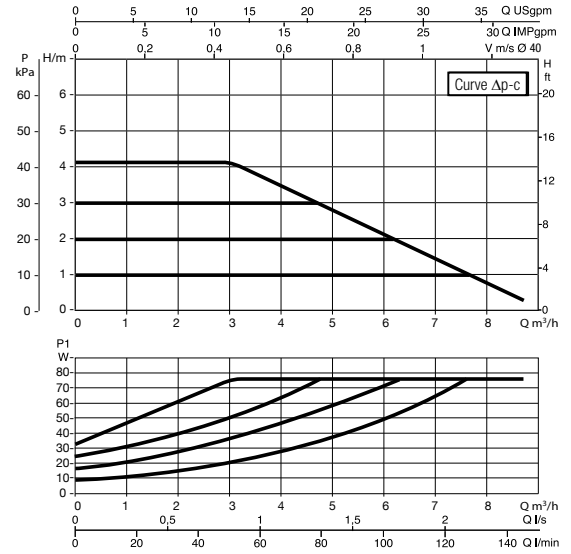
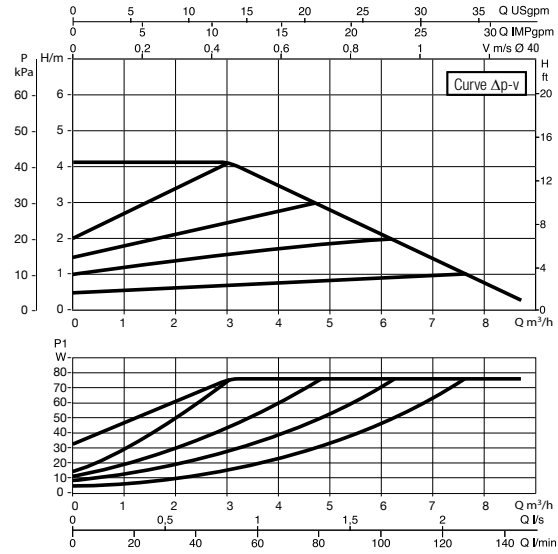

EVOPLUS B 60/250.40 M

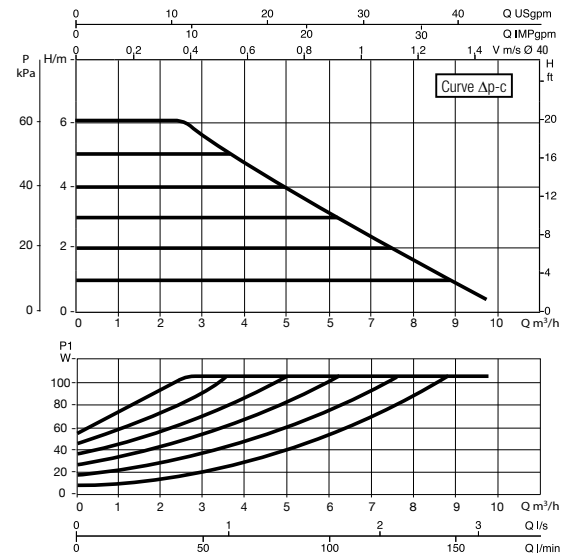
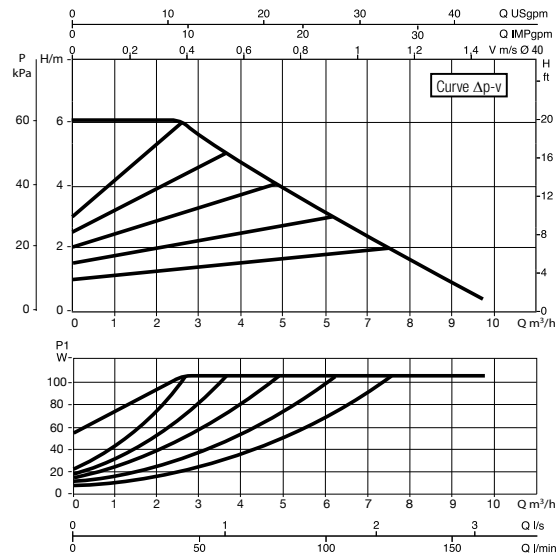

Curve tolerance according to ISO 9906.

EVOPLUS SMALL

ELECTRONIC CIRCULATORS FOR SMALL COMMUNITY HEATING

EVOPLUS B 80/250.40 M

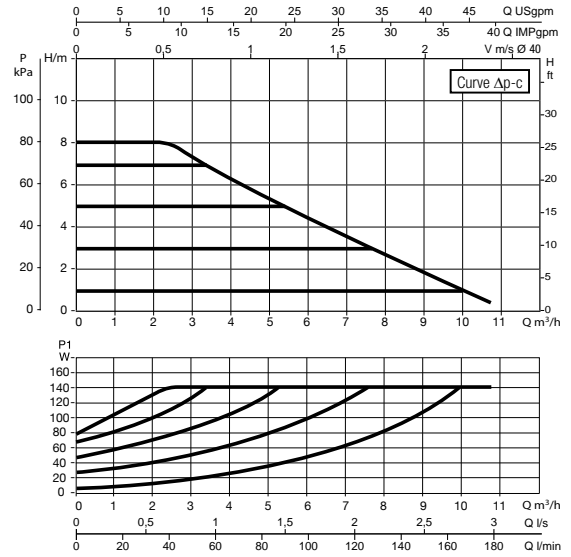
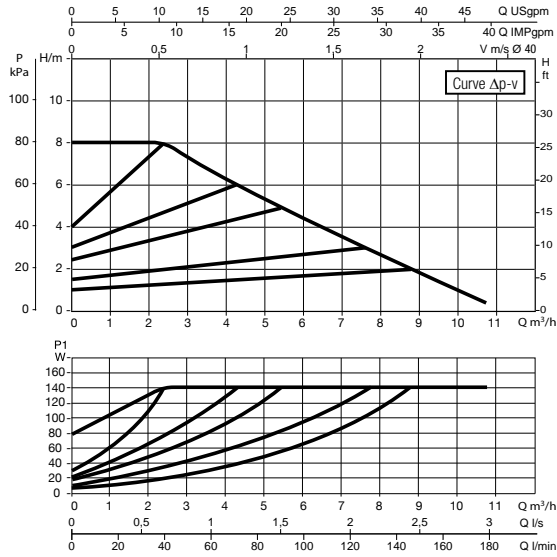

EVOPLUS B 110/250.40 M

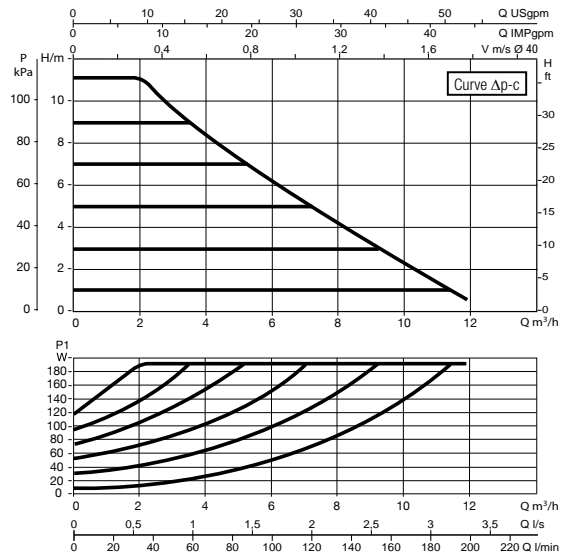
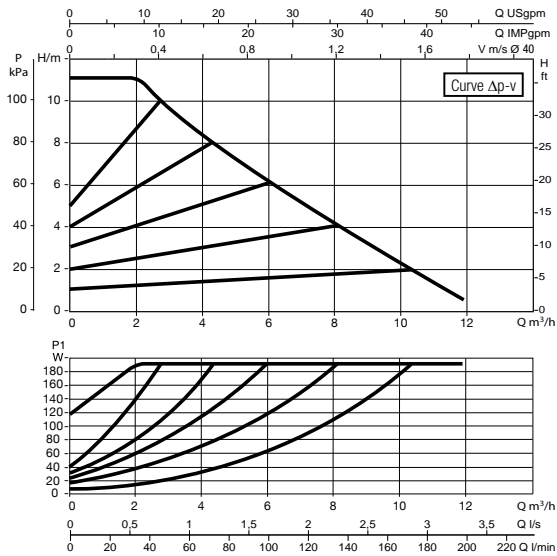

EVOPLUS D 40/220.32 M

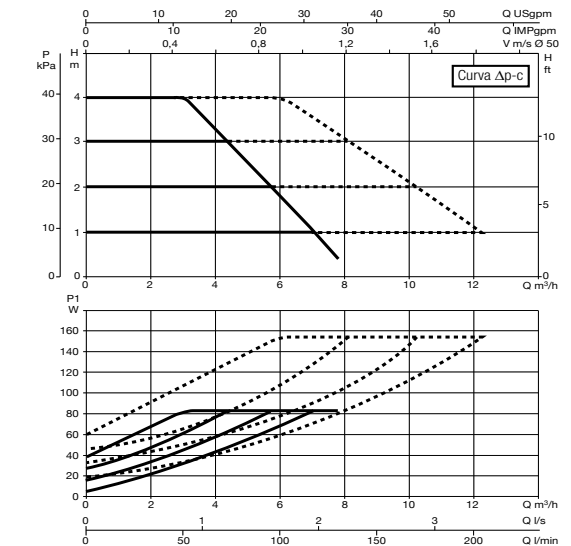
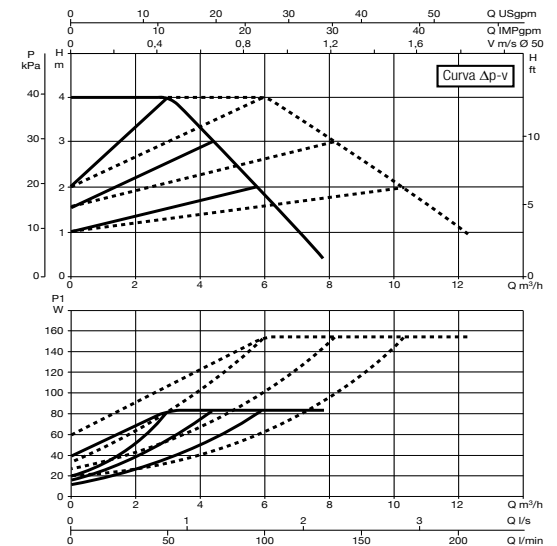

Curve tolerance according to ISO 9906.

HVAC

EVOPLUS SMALL

ELECTRONIC CIRCULATORS FOR SMALL COMMUNITY HEATING

EVOPLUS D 40/250.40 M

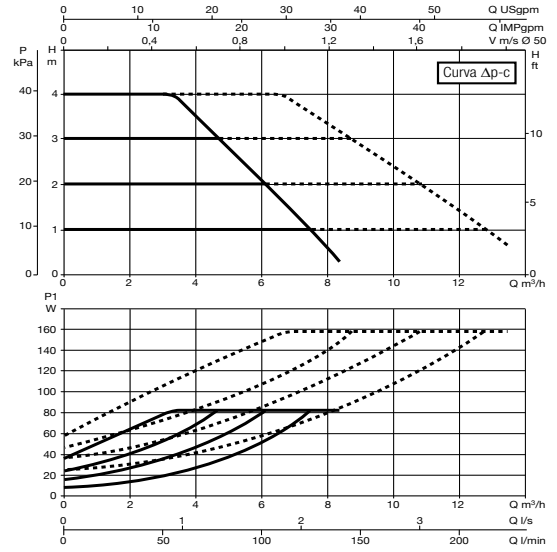
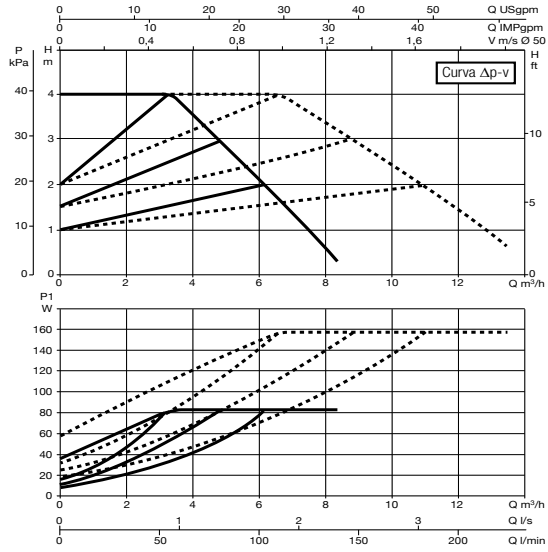

EVOPLUS D 60/250.40 M

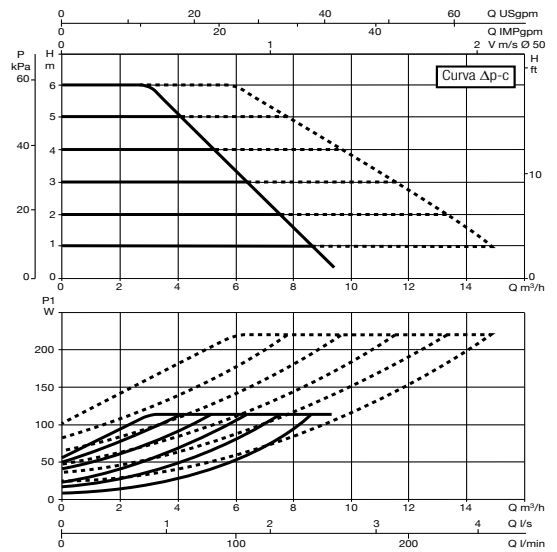
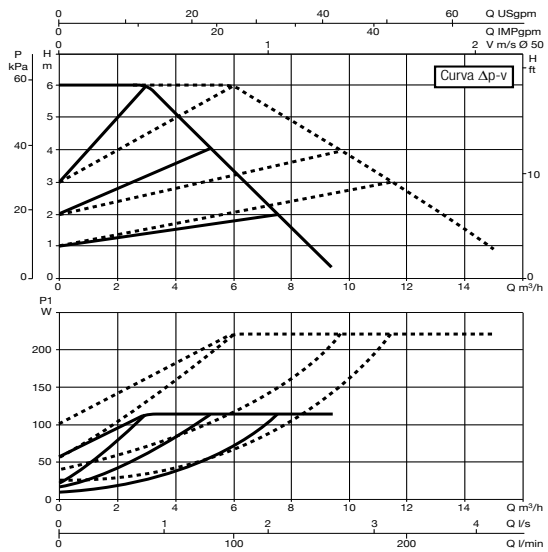

EVOPLUS D 80/250.40 M

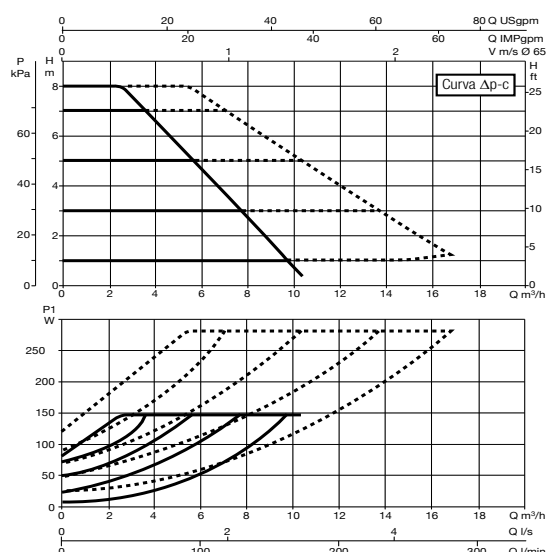
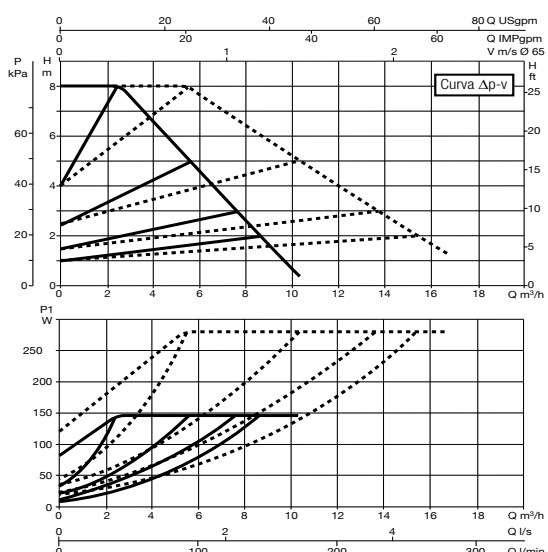

Curve tolerance according to ISO 9906.

HVAC

EVOPLUS SMALL

ELECTRONIC CIRCULATORS FOR SMALL COMMUNITY HEATING

EVOPLUS D110/250.40 M

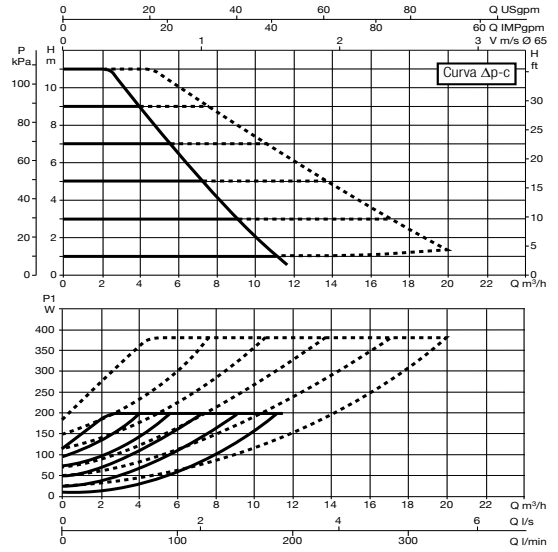
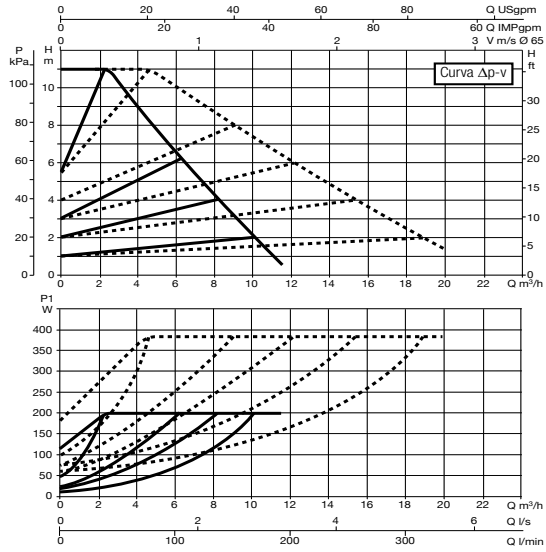

Curve tolerance according to ISO 9906.

EVOPLUS SMALL

ELECTRONIC CIRCULATORS FOR SMALL COMMUNITY HEATING

DIMENSIONS AND WEIGHTS

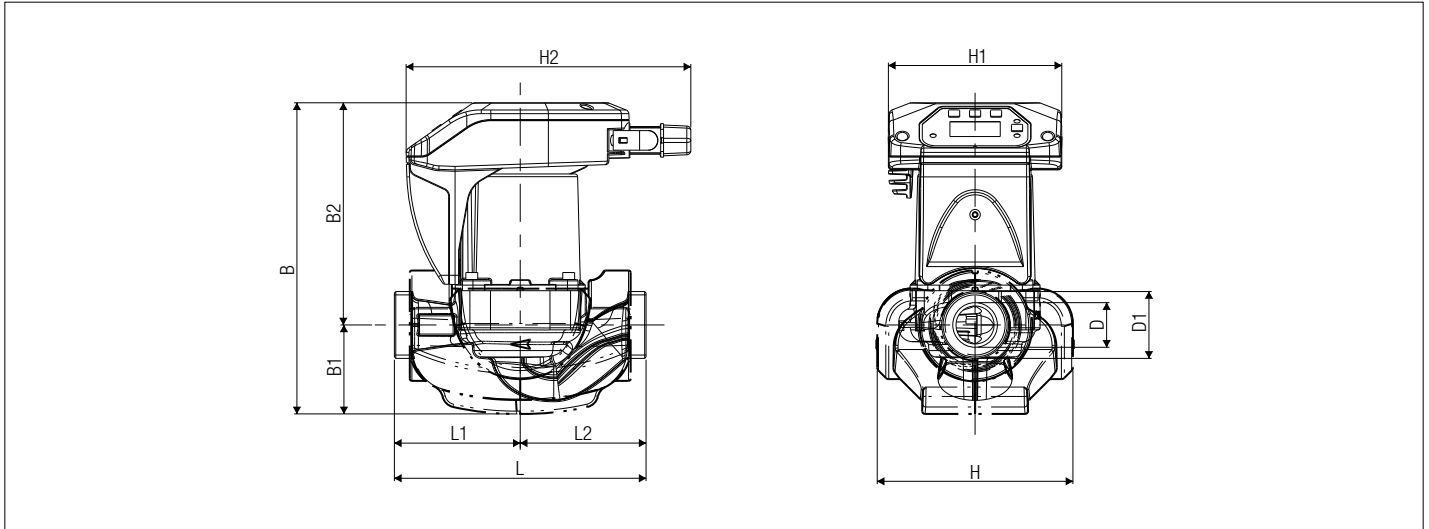

MODEL	L	L1	L2	L3	A	B	B1	B2	D	D1	D2	D3	D4	I	I1	I2	I3	M	H	H1	H2	WEIGHT lbs	Q.TY x PALLET
EVOPLUS B .../220.32 M	8.7	4.3	4.3	0.7	0.6	9.8	2.5	7.2	1.6	3.5	3.9	5.5	3	-	-	-	-	-	5.5	4.9	8	29.8	51
EVOPLUS B .../250.40 M	9.8	4.9	4.9	0.7	0.6	9.8	2.5	7.2	1.7	3.9	4.3	5.9	3.3	-	-	-	-	-	5.5	4.9	8	31.3	51

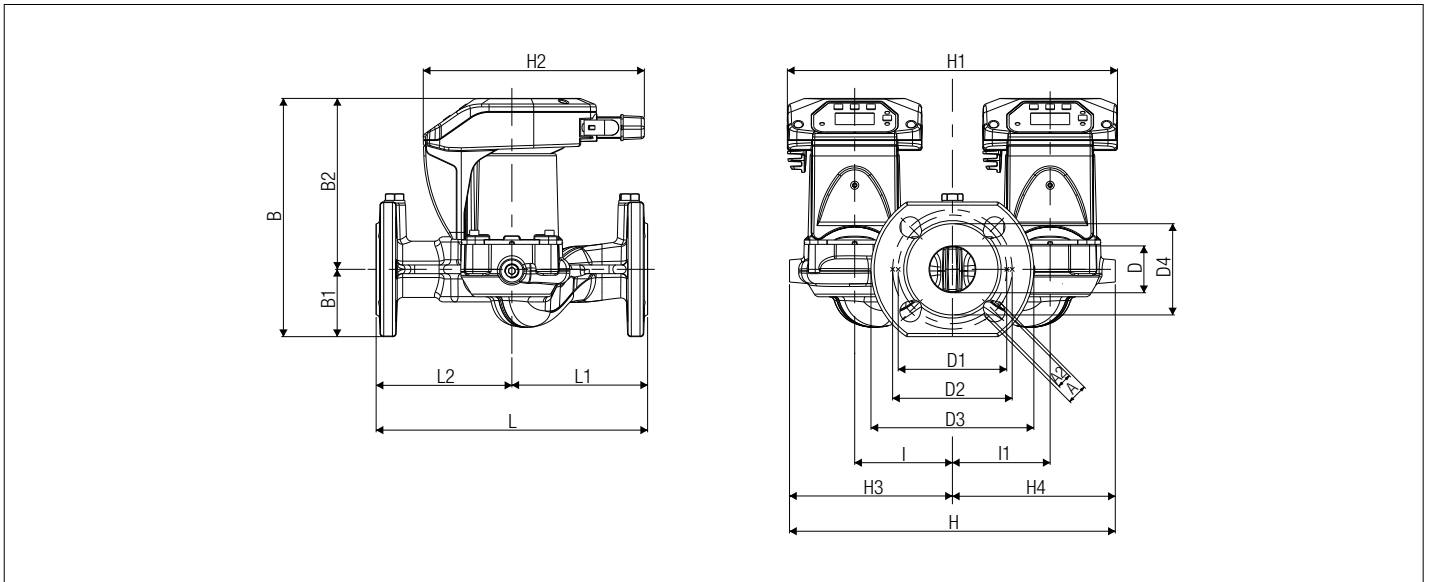

MODEL	L	L1	L2	L3	A	B	B1	B2	D	D1	D2	D3	D4	I	I1	M	H	H1	H2	H3	H4	WEIGHT lbs	Q.TY x PALLET
EVOPLUS D .../220.32 M	8.7	4.9	4.9	0.7	0.6	8.7	2.4	6.2	1.7	3.9	4.3	5.9	3.3	3.5	3.5	--	11.8	12	8	5.9	5.9	13.5	30
EVOPLUS D .../250.40 M	9.8	4.9	4.9	0.7	0.6	8.7	2.4	6.2	1.7	3.9	4.3	5.9	3.3	3.5	3.5	--	11.8	12	8	5.9	5.9	14.2	30

EVOPLUS

CIRCULATORS FOR HEATING AND AIR-CONDITIONING SYSTEMS



evoplus⁺

EVOPLUS electronic circulators can be used in heating, ventilation and air conditioning systems for residential and commercial buildings. In all correctly sized installations, the electronically controlled wet rotor pumps constantly ensure sufficient power and, simultaneously, lower noise emissions, greater comfort and a significant reduction in running costs. All models fitted with flanged pump body are available in both single and twin versions. The user interface is easy to use and easy to understand.

Circulator protection rate IP 44

Insulation class F

Standard voltage single-phase 220/240V, 50/60Hz

In accordance with European standards
EN 61800-3 - EN 60335-1 - EN 60335-2-51

Operating range

from 8.8 to 332.9 GPM with head up to 59 ft

Liquid Temperature range from 14°F to 230°F

Pumped liquid clean, free from solids and mineral oils, not viscous, chemically neutral, close to the properties of water (max. glycol contents 30%)

Maximum working pressure 232 psi

Standard flanging

DN 32, DN 40, DN 50, DN 65, PN 6 / PN 10 / PN 16 (4 slots), DN 80 e DN 100, PN 6 (4 slots) usable with flange 4 holes PN10

Special version on demand

DN 80, DN 100 PN 10 / PN 16 (8 holes)

Installation with horizontal motor shaft



PENDING APPROVAL



PAG. 5

ACCESSORIES
PAG. 205

MODES OF OPERATION

All the functions listed below can be consulted by the users (including less experienced ones) by simply scrolling through the menu. The calibration and the modification of the parameters are protected, and can only be completed by expert users. The factory settings of the EVOPLUS range are for proportional differential pressure control mode in the curve that ensures the best energy efficiency index (EEI).

1 - ΔP -v proportional differential pressure adjustment mode

With ΔP -v adjustment mode, with the variation of the flow rate, the value of the delivery of the head also varies in a linear manner, from H_{setp} to $H_{setp}/2$.

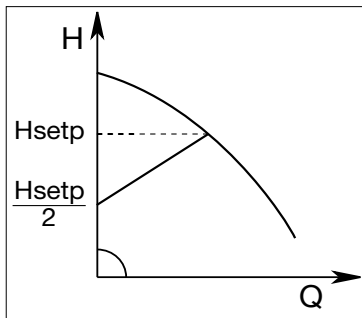

This adjustment is particularly indicated for the following systems:

a. Two-pipe heating systems with thermostat valves and with:

- head greater than 13 ft;
- very long circuit piping;
- valves with wide operating range;
- differential pressure regulators;
- high pressure drops in those parts of the system carrying the entirety of the water flow rate;
- low differential pressure.

b. Under-floor central heating systems with thermostatic valves and significant pressure drops in the boiler circuit.

c. Systems with primary circuit pumps with high pressure drops.

Example of set-up of the set-point with ΔP -v

The following operating point is required:

$Q = 28.6$ GPM

$H = 20$ ft

PROCEDURE:

1. In the graph, find the desired operating point, and then find the EVOPLUS curve closest to it (in this case the point lies precisely on the curve)
2. Follow the curve upwards until reaching the intersection with the limit curve of the circulator.
3. The head reading at this limit point is the set-point head that must be entered to obtain the desired operating point.

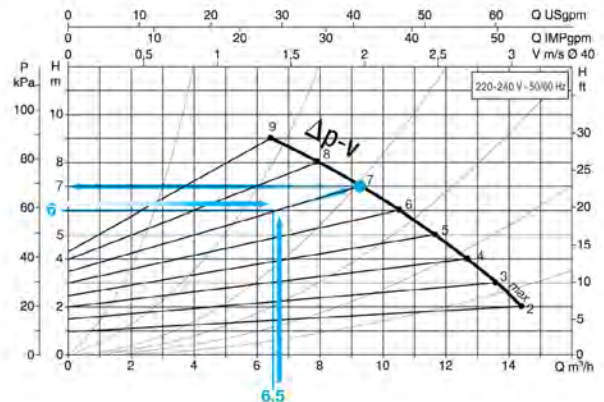

EVOPLUS

CIRCULATORS FOR HEATING AND AIR-CONDITIONING SYSTEMS

2 - ΔP -c constant differential pressure adjustment mode

The ΔP -c adjustment mode keeps the differential pressure of the system constantly at the H setp value set, even in case of variation of the flow rate.

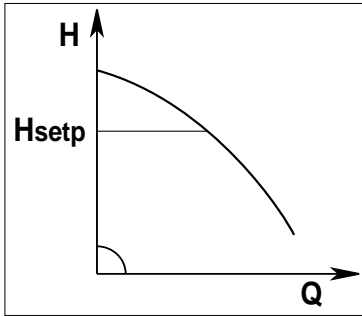

This adjustment is particularly indicated for the following systems:

a. Two-pipe heating systems with thermostat valves and with:

- head lower than 7 ft;
- natural circulation;
- low pressure drops in those parts of the system carrying the entirety of the water flow rate;
- high differential temperature (central heating).

b. underfloor heating systems with thermostat valves

c. single-pipe heating systems with thermostat valves and calibration valves

d. Systems with primary circuit pumps with low pressure drops.

3 - Constant curve adjustment modes

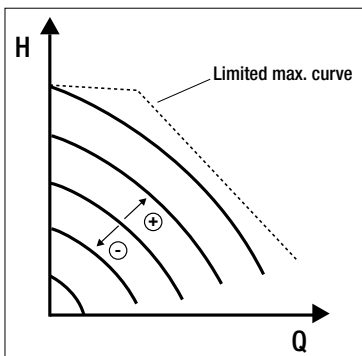

In this control mode, the circulator works based on constant speed characteristic curves. The operation curve is selected by setting the rotation speed using a percentage factor. The 100 % value indicates the maximum limit curve. The actual rotation speed may be affected by the power and differential pressure limitations of the actual circulator model. The rotation speed may be set using the display, or either a 0-10 V or PWM external signal.

Control mode indicated for constant flow rate heating and air conditioning systems.

4 - Constant differential pressure control mode with proportional control based on the water temperature

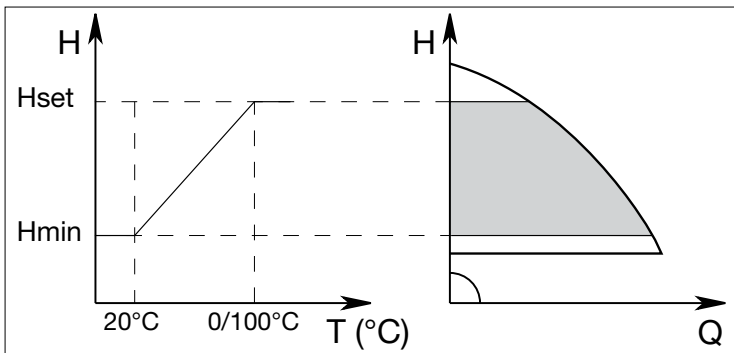

This adjustment is particularly indicated for the following systems:

- In variable flow rate systems (two-pipe central heating systems), for which a further reduction of the circulator performance levels is provided in accordance with the lowering of the temperature of the circulating liquid, in case of reduced heating demand.
- In constant flow rate systems (single-pipe and under-floor central heating systems), where the performance of the circulator can only be adjusted by activating the temperature influence function. It is set through the EVOPLUS control panel.

ECONOMY MODE

The economy function can be set directly on the control panel, by setting a reduction value (f. rid), the maximum value of which can be 50%. In all the previously listed settings, the Hset value must be replaced with an $Hset \times f. rid$.

EVOPLUS

CIRCULATORS FOR HEATING AND AIR-CONDITIONING SYSTEMS

TECHNICAL DATA - EVOPLUS B SINGLE WITH FLANGES

	MODEL	CODE	CENTRE DISTANCE in	ELECTRICAL DATA		In A	COUNTERFLANGES ON REQUEST	E E I	MINIMUM SUCTION PRESSURE		
				VOLTAGE 60 Hz	P1 MAX W				t°	194 F	212 F
DN 32	EVOPLUS B 120/220.32 M	60150962	8.7	220/240 V	340	1.7	DN 32 PN 6	EEI ≤ 0.22	ft.c.w.	66	82
DN 40	EVOPLUS B 40/220.40 M	60150963	8.7	220/240 V	90	0.7	DN 40 PN 10	EEI ≤ 0.23	ft.c.w.	66	82
	EVOPLUS B 60/220.40 M	60150964	8.7	220/240 V	175	1	DN 40 PN 10	EEI ≤ 0.23	ft.c.w.	66	82
	EVOPLUS B 80/220.40 M	60150965	8.7	220/240 V	260	1.35	DN 40 PN 10	EEI ≤ 0.21	ft.c.w.	66	82
	EVOPLUS B 100/220.40 M	60150966	8.7	220/240 V	350	1.75	DN 40 PN 10	EEI ≤ 0.20	ft.c.w.	66	82
	EVOPLUS B 120/250.40 M	60150967	9.8	220/240 V	465	2.2	DN 40 PN 10	EEI ≤ 0.20	ft.c.w.	66	82
	EVOPLUS B 150/250.40 M	60150968	9.8	220/240 V	610	2.9	DN 40 PN 10	EEI ≤ 0.20	ft.c.w.	66	82
	EVOPLUS B 180/250.40 M	60150969	9.8	220/240 V	610	2.9	DN 40 PN 10	EEI ≤ 0.20	ft.c.w.	66	82
DN 50	EVOPLUS B 40/240.50 M	60150970	9.4	220/240 V	140	0.87	DN 50 PN 10	EEI ≤ 0.23	ft.c.w.	66	82
	EVOPLUS B 60/240.50 M	60150971	9.4	220/240 V	260	1.35	DN 50 PN 10	EEI ≤ 0.21	ft.c.w.	66	82
	EVOPLUS B 80/240.50 M	60150972	9.4	220/240 V	330	0.87	DN 50 PN 10	EEI ≤ 0.21	ft.c.w.	66	82
	EVOPLUS B 100/280.50 M	60150973	11	220/240 V	430	2.1	DN 50 PN 10	EEI ≤ 0.20	ft.c.w.	66	82
	EVOPLUS B 120/280.50 M	60150974	11	220/240 V	530	2.5	DN 50 PN 10	EEI ≤ 0.19	ft.c.w.	66	82
	EVOPLUS B 150/280.50 M	60150975	11	220/240 V	640	3	DN 50 PN 10	EEI ≤ 0.19	ft.c.w.	66	82
	EVOPLUS B 180/280.50 M	60150976	11	220/240 V	750	3.45	DN 50 PN 10	EEI ≤ 0.19	ft.c.w.	66	82
DN 65	EVOPLUS B 40/340.65 M	60150977	13.4	220/240 V	190	1.1	DN 65 PN 10	EEI ≤ 0.21	ft.c.w.	66	82
	EVOPLUS B 60/340.65 M	60150978	13.4	220/240 V	355	1.8	DN 65 PN 10	EEI ≤ 0.20	ft.c.w.	66	82
	EVOPLUS B 80/340.65 M	60150979	13.4	220/240 V	465	2.2	DN 65 PN 10	EEI ≤ 0.19	ft.c.w.	66	82
	EVOPLUS B 100/340.65 M	60150980	13.4	220/240 V	590	2.8	DN 65 PN 10	EEI ≤ 0.18	ft.c.w.	66	82
	EVOPLUS B 120/340.65 M	60150981	13.4	220/240 V	730	3.45	DN 65 PN 10	EEI ≤ 0.18	ft.c.w.	66	82
	EVOPLUS B 150/340.65 M	60150986	13.4	220/240 V	1210	5.5	DN 65 PN 10	EEI ≤ 0.18	ft.c.w.	66	25
DN 80	EVOPLUS B 40/360.80 M	60150987	14.2	220/240 V	330	1.65	DN 80 PN 10	EEI ≤ 0.19	ft.c.w.	66	82
	EVOPLUS B 60/360.80 M	60150988	14.2	220/240 V	535	2.5	DN 80 PN 10	EEI ≤ 0.20	ft.c.w.	66	82
	EVOPLUS B 80/360.80 M	60150989	14.2	220/240 V	670	3	DN 80 PN 10	EEI ≤ 0.20	ft.c.w.	66	82
	EVOPLUS B 100/360.80 M	60150990	14.2	220/240 V	1005	4.5	DN 80 PN 10	EEI ≤ 0.19	ft.c.w.	66	82
	EVOPLUS B 120/360.80 M	60150991	14.2	220/240 V	1235	5.5	DN 80 PN 10	EEI ≤ 0.19	ft.c.w.	66	82
DN 100	EVOPLUS B 40/450.100 M	60150992	17.7	220/240 V	530	2.5	DN 100 PN 10	EEI ≤ 0.19	ft.c.w.	66	82
	EVOPLUS B 60/450.100 M	60150993	17.7	220/240 V	760	3.5	DN 100 PN 10	EEI ≤ 0.18	ft.c.w.	66	82
	EVOPLUS B 80/450.100 M	60150994	17.7	220/240 V	1080	4.8	DN 100 PN 10	EEI ≤ 0,18	ft.c.w.	66	82
	EVOPLUS B 100/450.100 M	60150995	17.7	220/240 V	1380	6	DN 100 PN 10	EEI ≤ 0.19	ft.c.w.	66	82
	EVOPLUS B 120/450.100 M	60150999	17.7	220/240 V	1560	7	DN 100 PN 10	EEI ≤ 0.19	ft.c.w.	66	82

EVOPLUS

CIRCULATORS FOR HEATING AND AIR-CONDITIONING SYSTEMS

SPECIAL VERSION - TWIN FLANGED PN 16

	MODEL	CODE	CENTRE DISTANCE in	ELECTRICAL DATA		In A	COUNTERFLANGES ON REQUEST	E E I
				VOLTAGE 60 Hz	P1 MAX W			
DN 80	EVOPLUS B 40/360.80 M	60153017	14.2	220/240 V	330	1.65	DN80 PN 16	EEI ≤ 0.19
	EVOPLUS B 60/360.80 M	60153018	14.2	220/240 V	535	2.5	DN80 PN 16	EEI ≤ 0.20
	EVOPLUS B 80/360.80 M	60153019	14.2	220/240 V	670	3	DN80 PN 16	EEI ≤ 0.20
	EVOPLUS B 100/360.80 M	60153020	14.2	220/240 V	1005	4.5	DN80 PN 16	EEI ≤ 0.19
	EVOPLUS B 120/360.80 M	60153021	14.2	220/240 V	1235	5.5	DN80 PN 16	EEI ≤ 0.19
DN 100	EVOPLUS B 40/450.100 M	60153022	17.7	220/240 V	530	2.5	DN100 PN 16	EEI ≤ 0.19
	EVOPLUS B 60/450.100 M	60153023	17.7	220/240 V	760	3.5	DN100 PN 16	EEI ≤ 0.18
	EVOPLUS B 80/450.100 M	60153024	17.7	220/240 V	1080	4.8	DN100 PN 16	EEI ≤ 0.18
	EVOPLUS B 100/450.100 M	60153025	17.7	220/240 V	1380	6	DN100 PN 16	EEI ≤ 0.19
	EVOPLUS B 120/450.100 M	60153026	17.7	220/240 V	1560	7	DN100 PN 16	EEI ≤ 0.19

TECHNICAL DATA - EVOPLUS D TWIN FLANGED

	MODEL	CODE	CENTRE DISTANCE in	ELECTRICAL DATA		In A	COUNTERFLANGES ON REQUEST	E E I	MINIMUM SUCTION PRESSURE		
				VOLTAGE 60 Hz	P1 MAX W				t°	194 F	212 F
DN 32	EVOPLUS D 120/220.32 M	60151000	8.7	220/240 V	340	1.7	DN 32 PN 6	EEI ≤ 0.22	ft.c.w.	66	82
DN 40	EVOPLUS D 40/220.40 M	60151001	8.7	220/240 V	90	0.7	DN 40 PN 10	EEI ≤ 0.23	ft.c.w.	66	82
	EVOPLUS D 60/220.40 M	60151002	8.7	220/240 V	175	1	DN 40 PN 10	EEI ≤ 0.23	ft.c.w.	66	82
	EVOPLUS D 80/220.40 M	60151003	8.7	220/240 V	260	1.35	DN 40 PN 10	EEI ≤ 0.23	ft.c.w.	66	82
	EVOPLUS D 100/220.40 M	60151004	8.7	220/240 V	350	1.75	DN 40 PN 10	EEI ≤ 0.23	ft.c.w.	66	82
	EVOPLUS D 120/250.40 M	60151005	9.8	220/240 V	465	2.2	DN 40 PN 10	EEI ≤ 0.23	ft.c.w.	66	82
	EVOPLUS D 150/250.40 M	60151006	9.8	220/240 V	610	2.9	DN 40 PN 10	EEI ≤ 0.23	ft.c.w.	66	82
	EVOPLUS D 180/250.40 M	60151007	9.8	220/240 V	610	2.9	DN 40 PN 10	EEI ≤ 0.23	ft.c.w.	66	82
DN 50	EVOPLUS D 40/240.50 M	60151008	9.4	220/240 V	140	0.87	DN 50 PN 10	EEI ≤ 0.23	ft.c.w.	66	82
	EVOPLUS D 60/240.50 M	60151009	9.4	220/240 V	260	1.35	DN 50 PN 10	EEI ≤ 0.22	ft.c.w.	66	82
	EVOPLUS D 80/240.50 M	60151010	9.4	220/240 V	330	1.7	DN 50 PN 10	EEI ≤ 0.22	ft.c.w.	66	82
	EVOPLUS D 100/280.50 M	60151011	11	220/240 V	430	2.1	DN 50 PN 10	EEI ≤ 0.22	ft.c.w.	66	82
	EVOPLUS D 120/280.50 M	60151012	11	220/240 V	530	2.5	DN 50 PN 10	EEI ≤ 0.22	ft.c.w.	66	82
	EVOPLUS D 150/280.50 M	60151013	11	220/240 V	640	3	DN 50 PN 10	EEI ≤ 0.21	ft.c.w.	66	82
	EVOPLUS D 180/280.50 M	60151014	11	220/240 V	750	3.45	DN 50 PN 10	EEI ≤ 0.21	ft.c.w.	66	82
DN 65	EVOPLUS D 40/340.65 M	60151015	13.4	220/240 V	190	1.1	DN 65 PN 10	EEI ≤ 0.21	ft.c.w.	66	82
	EVOPLUS D 60/340.65 M	60151016	13.4	220/240 V	355	1.8	DN 65 PN 10	EEI ≤ 0.21	ft.c.w.	66	82
	EVOPLUS D 80/340.65 M	60151017	13.4	220/240 V	465	2.2	DN 65 PN 10	EEI ≤ 0.21	ft.c.w.	66	82
	EVOPLUS D 100/340.65 M	60151018	13.4	220/240 V	590	2.8	DN 65 PN 10	EEI ≤ 0.20	ft.c.w.	66	82
	EVOPLUS D 120/340.65 M	60151019	13.4	220/240 V	730	3.45	DN 65 PN 10	EEI ≤ 0.20	ft.c.w.	66	82
	EVOPLUS D 150/340.65 M	60151020	13.4	220/240 V	1210	5.5	DN 65 PN 10	EEI ≤ 0.20	ft.c.w.	66	82

EVOPLUS

CIRCULATORS FOR HEATING AND AIR-CONDITIONING SYSTEMS

TECHNICAL DATA - EVOPLUS D TWIN FLANGED

	MODEL	CODE	CENTRE DISTANCE in	ELECTRICAL DATA		In A	COUNTERFLANGES ON REQUEST	E E I	MINIMUM SUCTION PRESSURE		
				VOLTAGE 60 Hz	P1 MAX W				t°	194 F	212 F
DN 80	EVOPLUS D 40/360.80 M	60151021	14.2	220/240 V	330	1.65	DN 80 PN 10	E E I ≤ 0.20	ft.c.w.	66	82
	EVOPLUS D 60/360.80 M	60151022	14.2	220/240 V	535	2.5	DN 80 PN 10	E E I ≤ 0.20	ft.c.w.	66	82
	EVOPLUS D 80/360.80 M	60151023	14.2	220/240 V	670	3	DN 80 PN 10	E E I ≤ 0.20	ft.c.w.	66	82
	EVOPLUS D 100/360.80 M	60151024	14.2	220/240 V	1005	4.	DN 80 PN 10	E E I ≤ 0.19	ft.c.w.	66	82
	EVOPLUS D 120/360.80 M	60151025	14.2	220/240 V	1235	5.5	DN 80 PN 10	E E I ≤ 0.19	ft.c.w.	66	82
DN 100	EVOPLUS D 40/450.100 M	60151026	17.7	220/240 V	530	2.5	DN 100 PN 10	E E I ≤ 0.19	ft.c.w.	66	82
	EVOPLUS D 60/450.100 M	60151027	17.7	220/240 V	760	3.5	DN 100 PN 10	E E I ≤ 0.19	m.c.w.	66	82
	EVOPLUS D 80/450.100 M	60151028	17.7	220/240 V	1080	4.8	DN 100 PN 10	E E I ≤ 0.20	ft.c.w.	66	82
	EVOPLUS D 100/450.100 M	60151029	17.7	220/240 V	1380	6	DN 100 PN 10	E E I ≤ 0.20	ft.c.w.	66	82
	EVOPLUS D 120/450.100 M	60151030	17.7	220/240 V	1560	7	DN 100 PN 10	E E I ≤ 0.20	ft.c.w.	66	82

SPECIAL VERSION - TWIN FLANGED PN 16

	MODEL	CODE	CENTRE DISTANCE in	ELECTRICAL DATA		In A	COUNTERFLANGES ON REQUEST	E E I	MINIMUM SUCTION PRESSURE		
				VOLTAGE 60 Hz	P1 MAX W				t°	194 F	212 F
DN 80	EVOPLUS D 40/360.80 M	60153028	14.2	220/240 V	330	1.65	DN 80 PN 16	E E I ≤ 0.20	ft.c.w.	66	82
	EVOPLUS D 60/360.80 M	60153029	14.2	220/240 V	535	2.5	DN 80 PN 16	E E I ≤ 0.20	ft.c.w.	66	82
	EVOPLUS D 80/360.80 M	60153030	14.2	220/240 V	670	3	DN 80 PN 16	E E I ≤ 0.20	ft.c.w.	66	82
	EVOPLUS D 100/360.80 M	60153031	14.2	220/240 V	1005	4.5	DN 80 PN 16	E E I ≤ 0.19	ft.c.w.	66	82
	EVOPLUS D 120/360.80 M	60153032	14.2	220/240 V	1235	5.5	DN 80 PN 16	E E I ≤ 0.19	ft.c.w.	66	82
DN 100	EVOPLUS D 40/450.100 M	60153033	17.7	220/240 V	530	2.5	DN 100 PN 16	E E I ≤ 0.19	ft.c.w.	66	82
	EVOPLUS D 60/450.100 M	60153034	17.7	220/240 V	760	3.5	DN 100 PN 16	E E I ≤ 0.19	ft.c.w.	66	82
	EVOPLUS D 80/450.100 M	60153035	17.7	220/240 V	1080	4.8	DN 100 PN 16	E E I ≤ 0.20	ft.c.w.	66	82
	EVOPLUS D 100/450.100 M	60153036	17.7	220/240 V	1380	6	DN 100 PN 16	E E I ≤ 0.20	ft.c.w.	66	82
	EVOPLUS D 120/450.100 M	60153037	17.7	220/240 V	1560	7	DN 100 PN 16	E E I ≤ 0.20	ft.c.w.	66	82

EVOPLUS

RANGE PERFORMANCE

EVOPLUS B 120/220.32 M

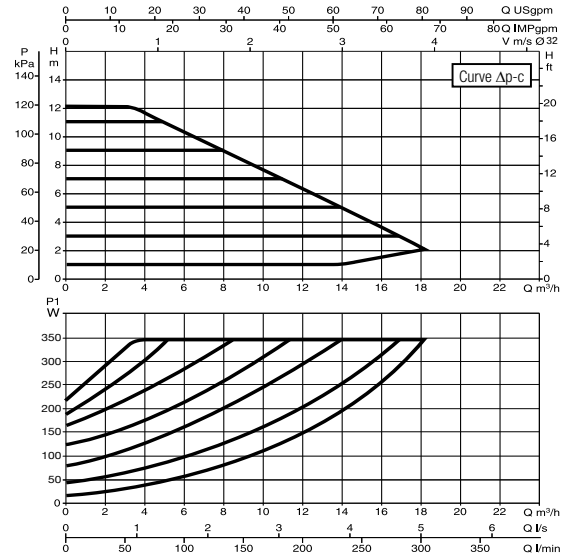
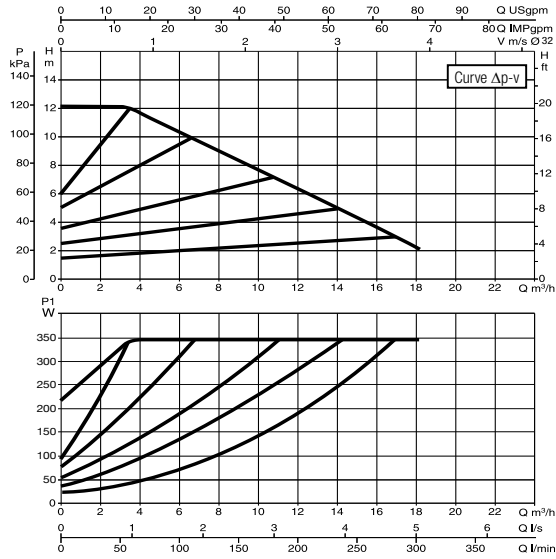

EVOPLUS B 40/220.40 M

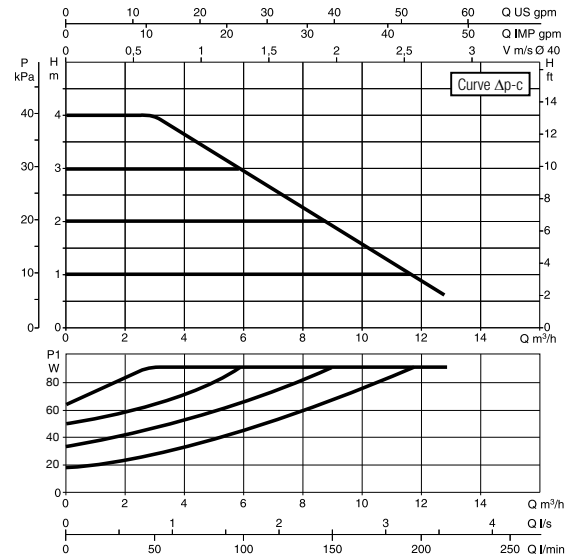
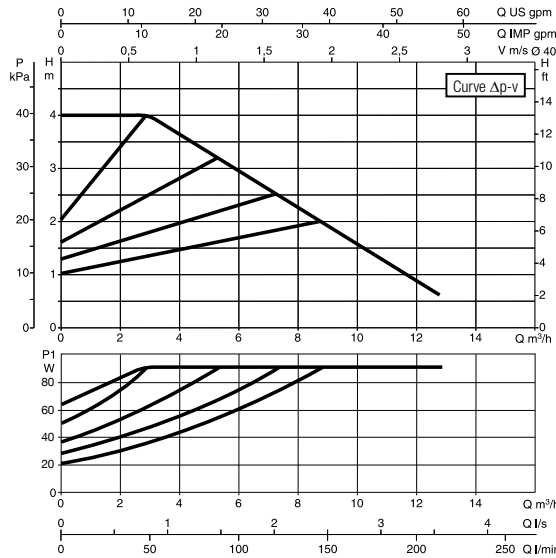

EVOPLUS B 60/220.40 M

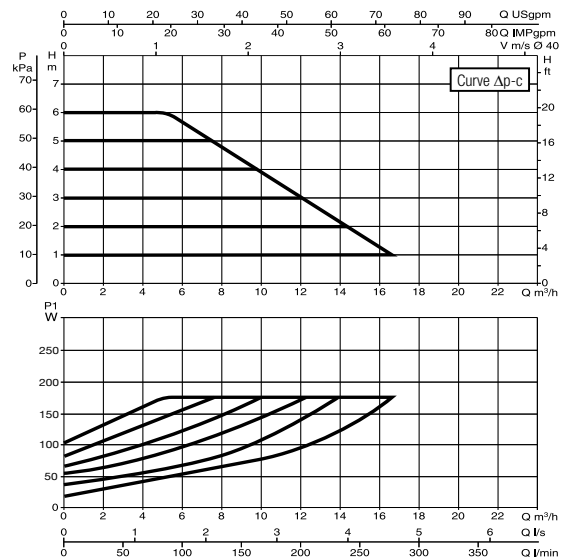
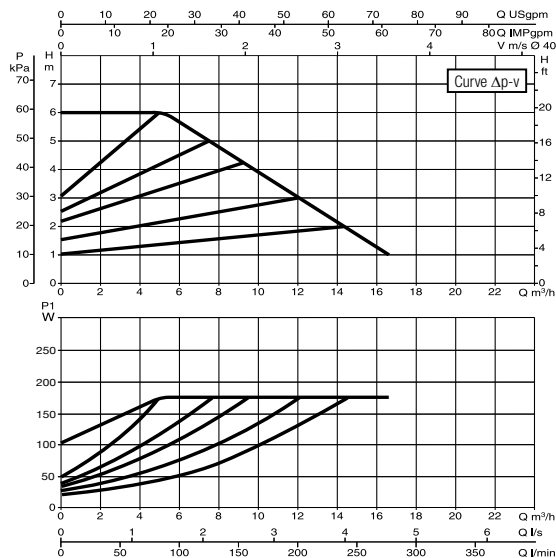

Curve tolerance according to ISO 9906.

HVAC

EVOPLUS

RANGE PERFORMANCE

EVOPLUS B 80/220.40 M

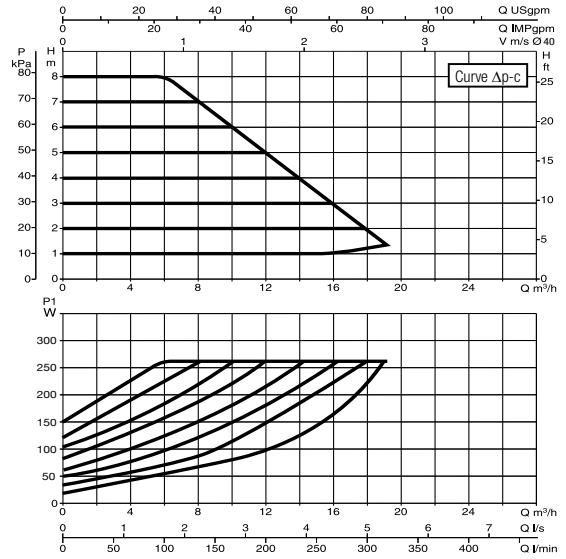
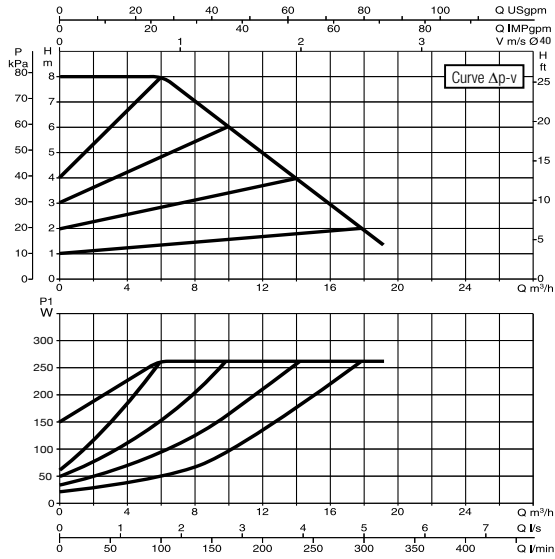

EVOPLUS B 100/220.40 M

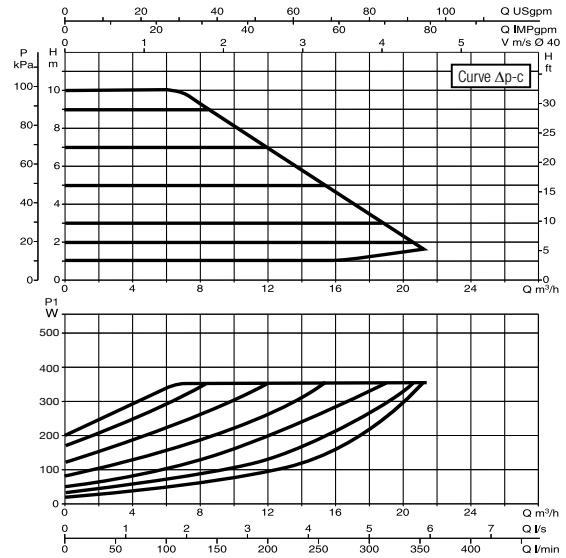
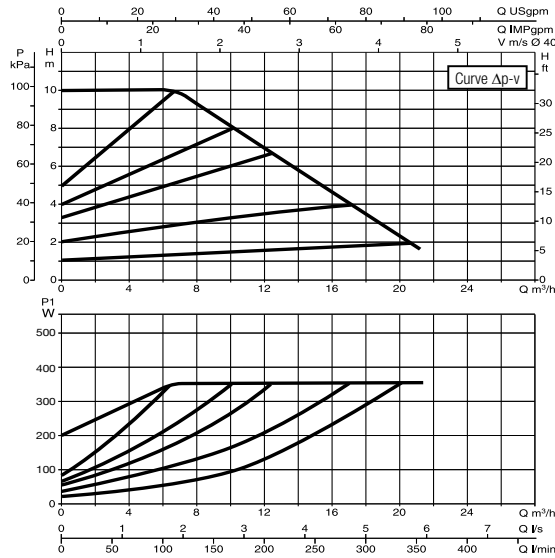

EVOPLUS B 120/250.40 M

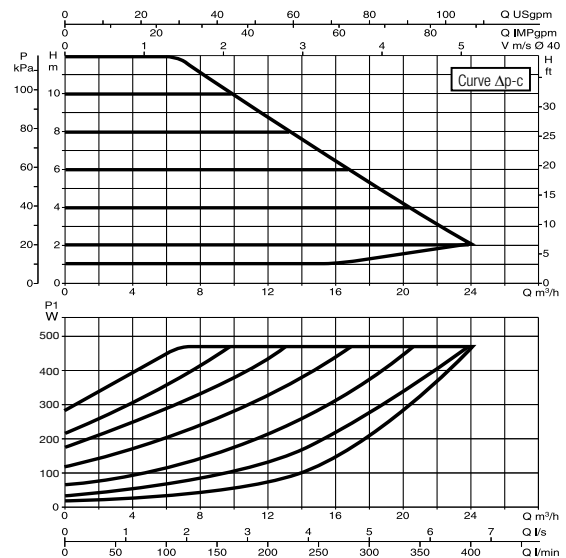
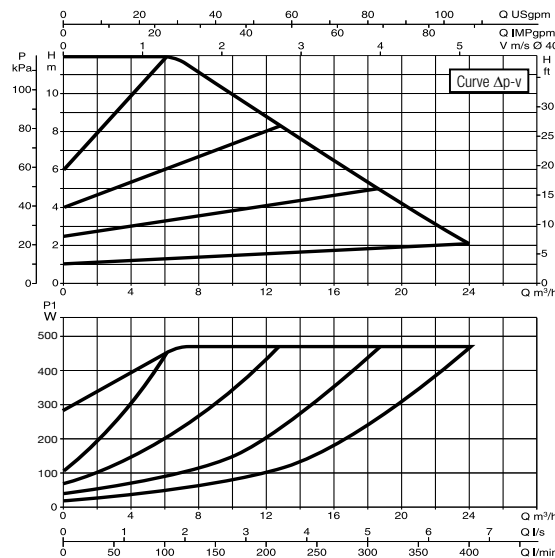

Curve tolerance according to ISO 9906.

EVOPLUS

RANGE PERFORMANCE

EVOPLUS B 150/250.40 M

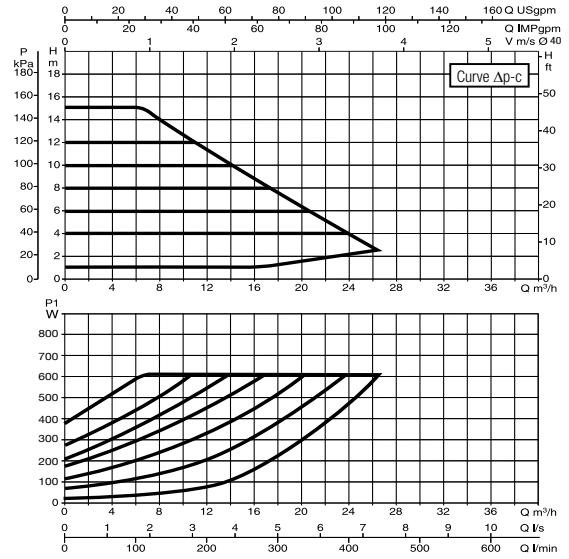
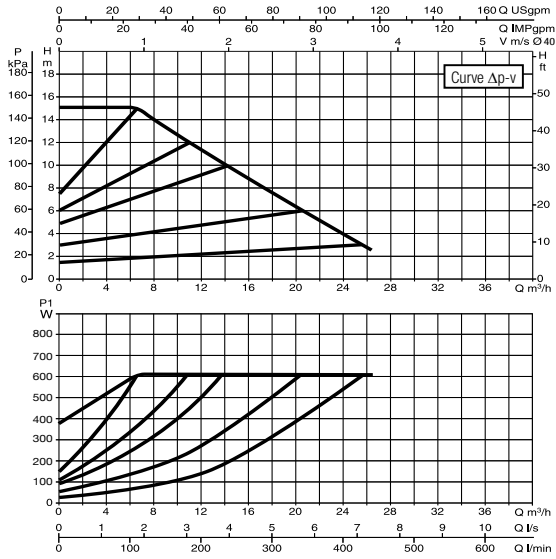

EVOPLUS B 180/250.40 M

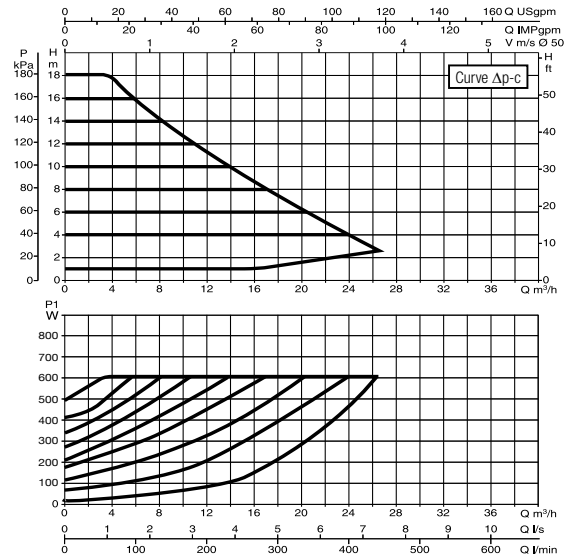
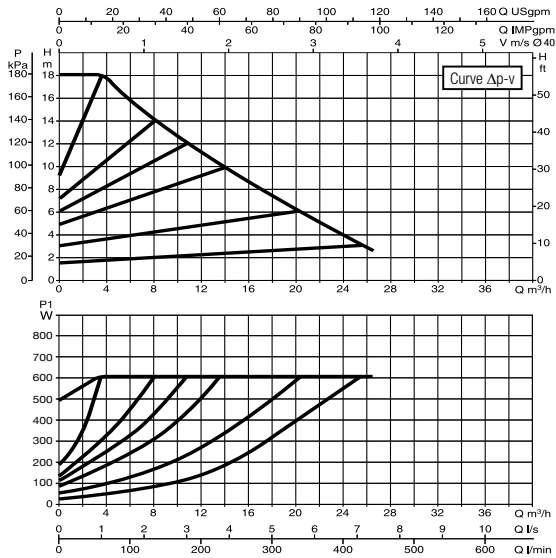

EVOPLUS B 40/240.50 M

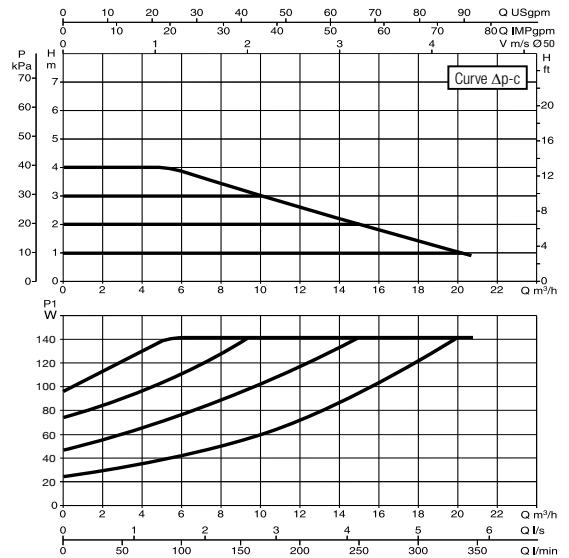
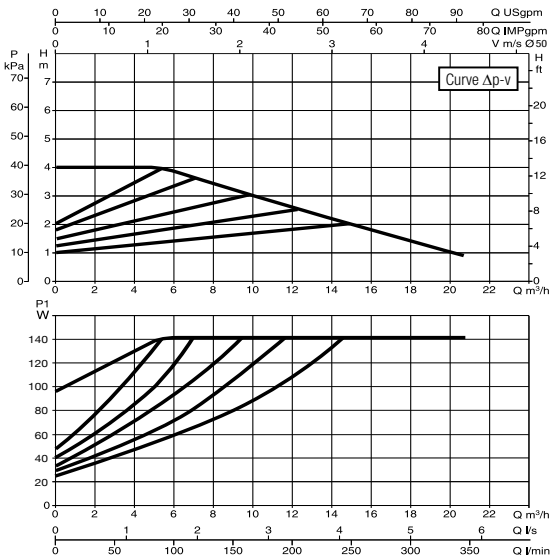

Curve tolerance according to ISO 9906.

HVAC

EVOPLUS

RANGE PERFORMANCE

EVOPLUS B 60/240.50 M

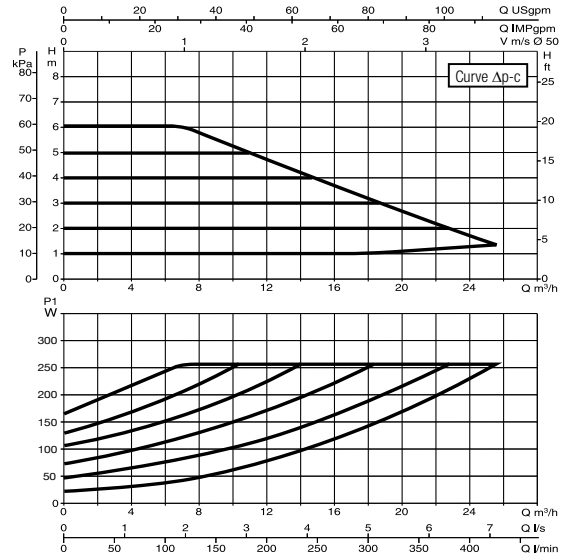
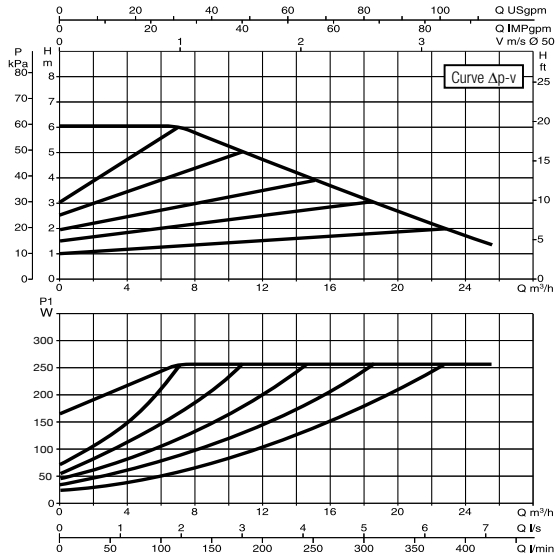

EVOPLUS B 80/240.50 M

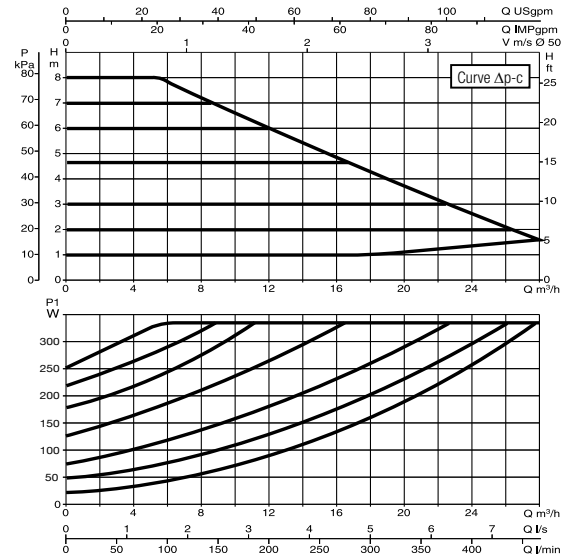
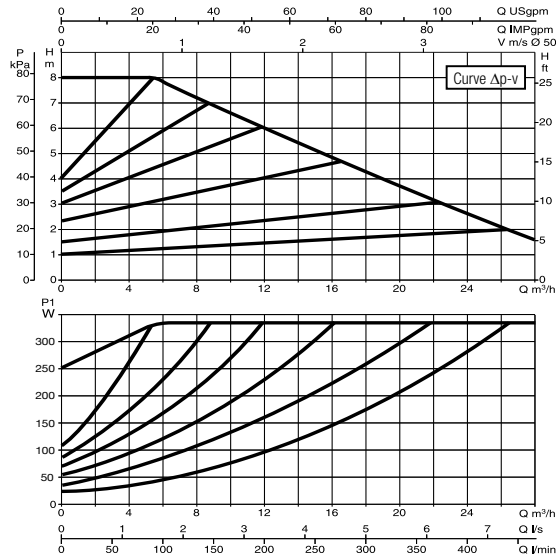

EVOPLUS B 100/280.50 M

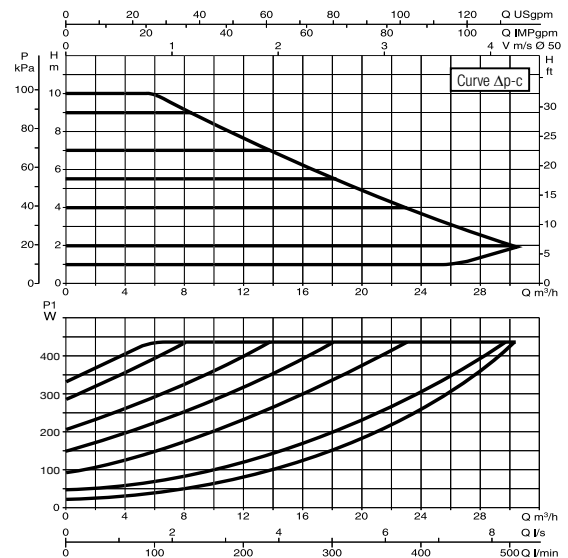
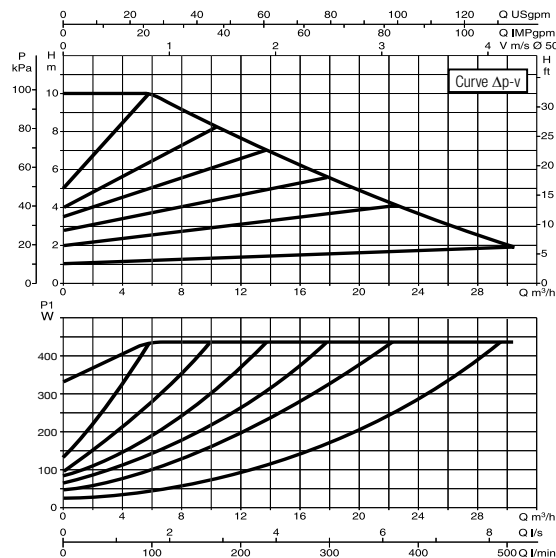

Curve tolerance according to ISO 9906.

EVOPLUS

RANGE PERFORMANCE

EVOPLUS B 120/280.50 M

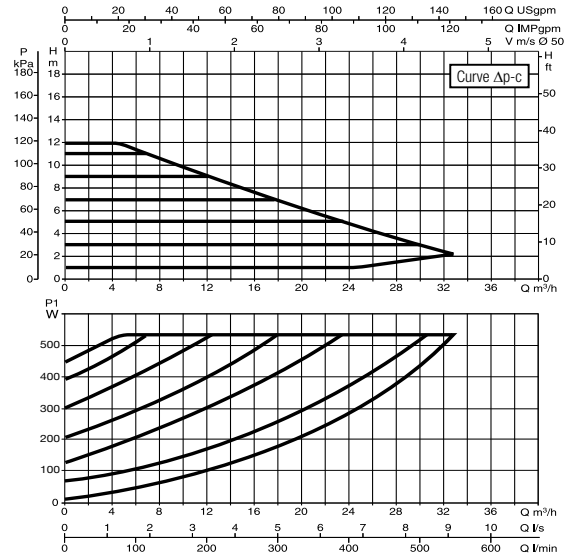
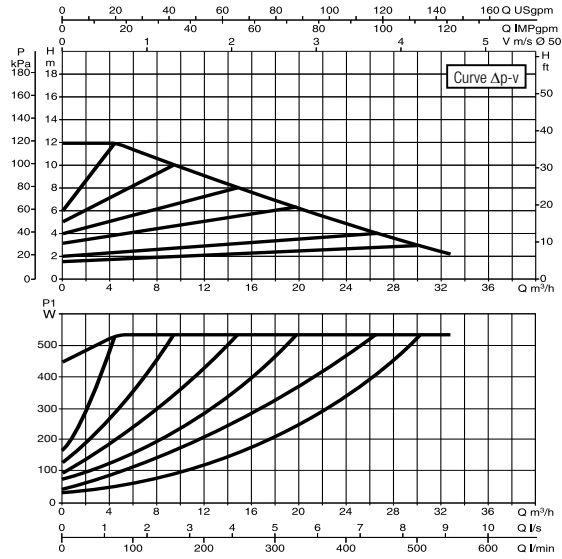

EVOPLUS B 150/280.50 M

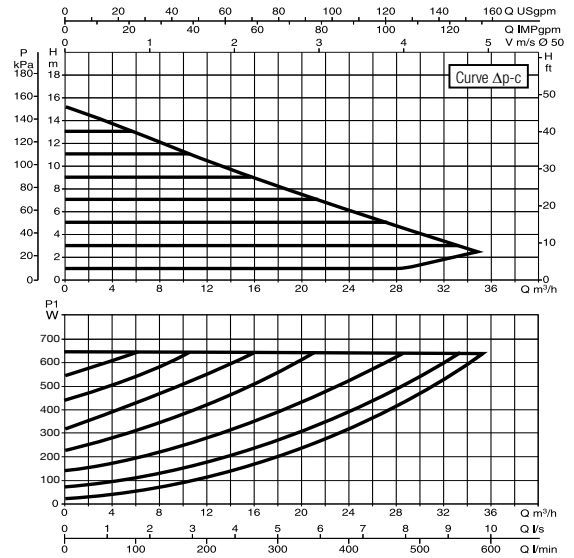
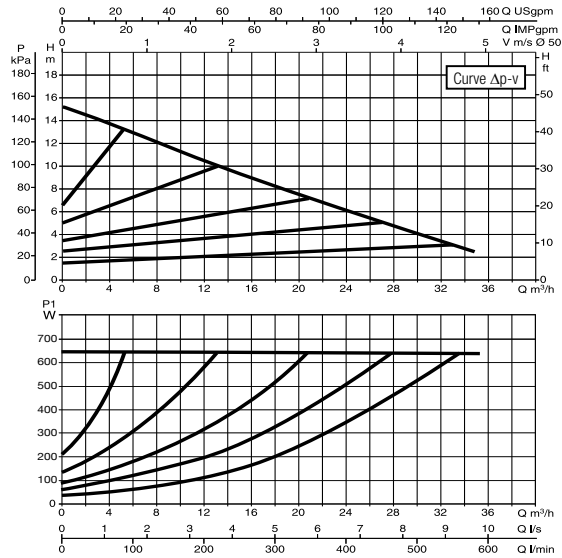

EVOPLUS B 180/280.50 M

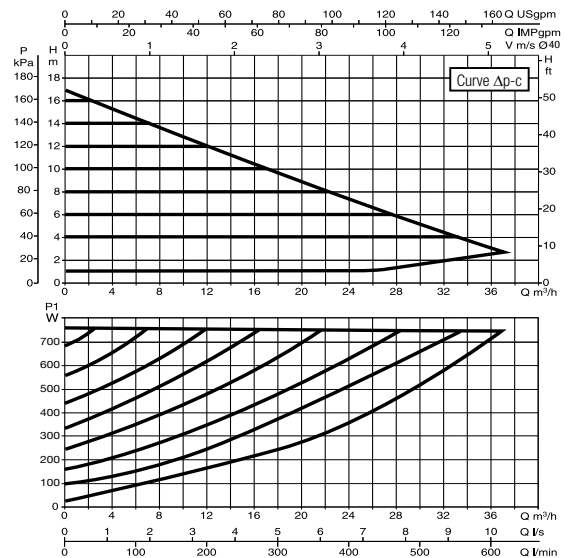
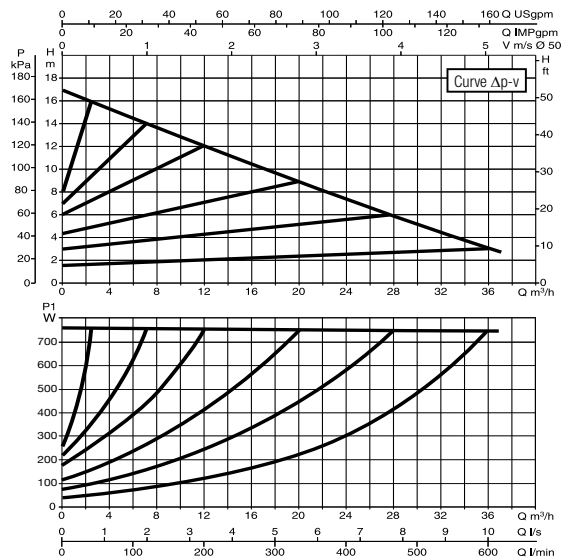

HVAC

Curve tolerance according to ISO 9906.

EVOPLUS

RANGE PERFORMANCE

EVOPLUS B 40/340.65 M

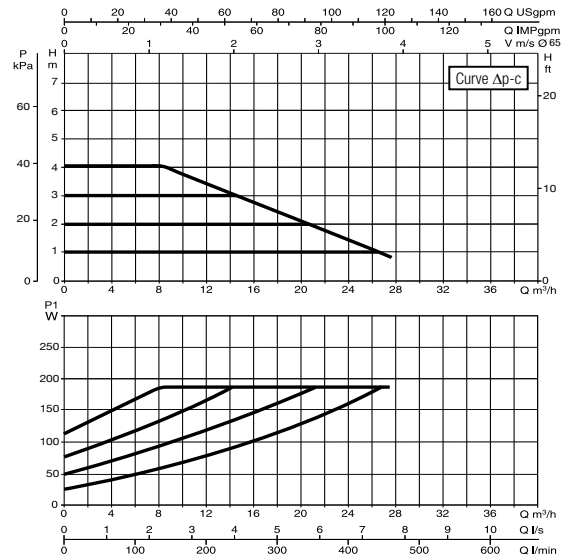
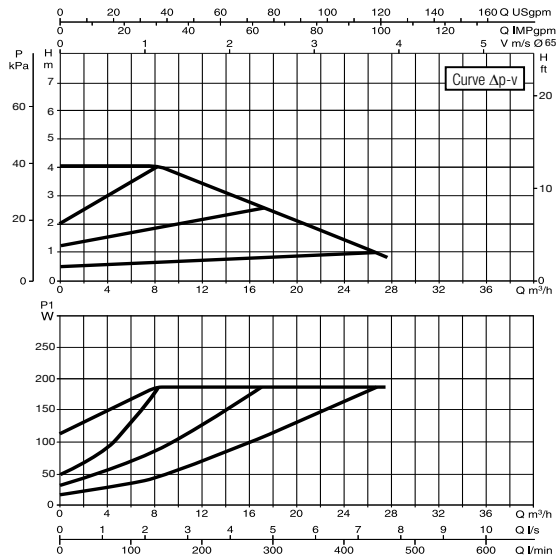

EVOPLUS B 60/340.65 M

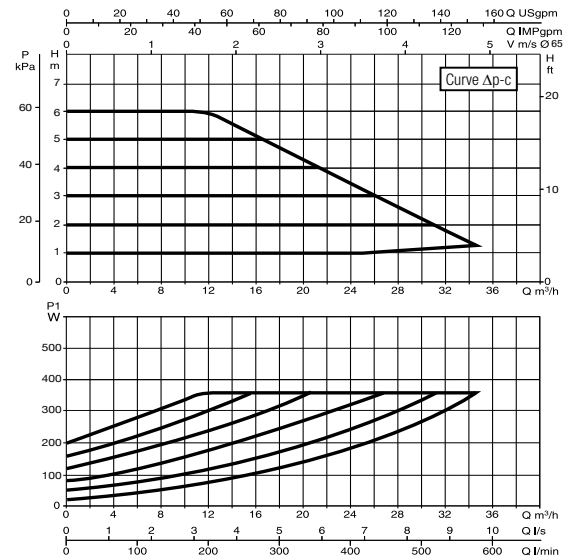
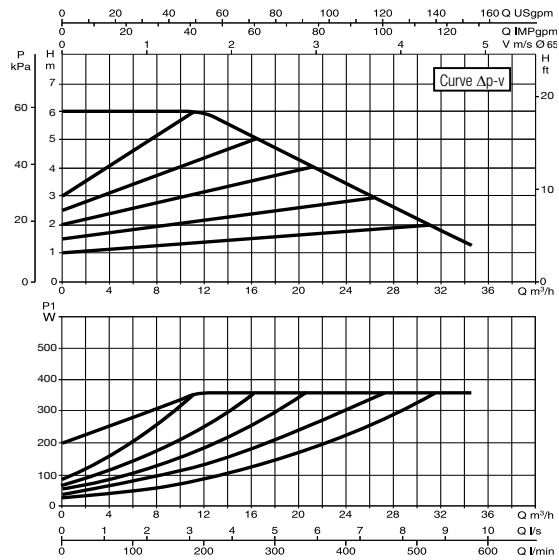

EVOPLUS B 80/340.65 M

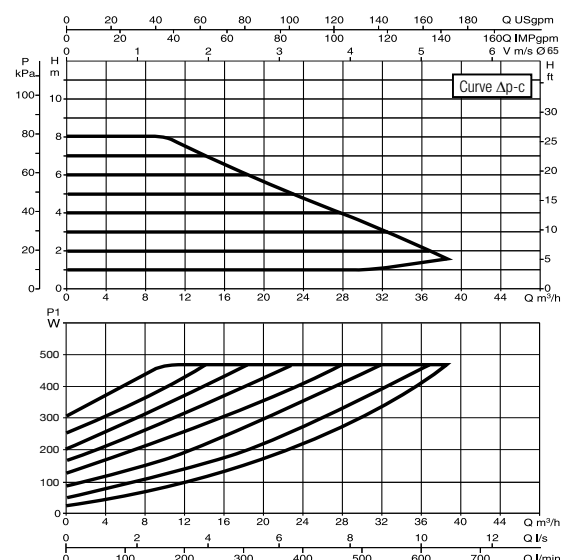
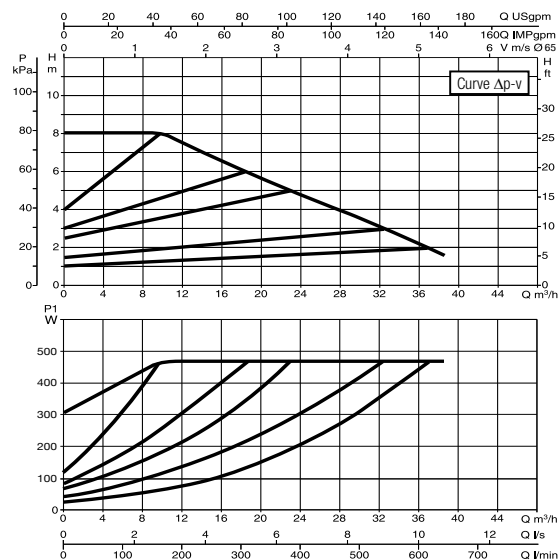

Curve tolerance according to ISO 9906.

EVOPLUS

RANGE PERFORMANCE

EVOPLUS B 100/340.65 M

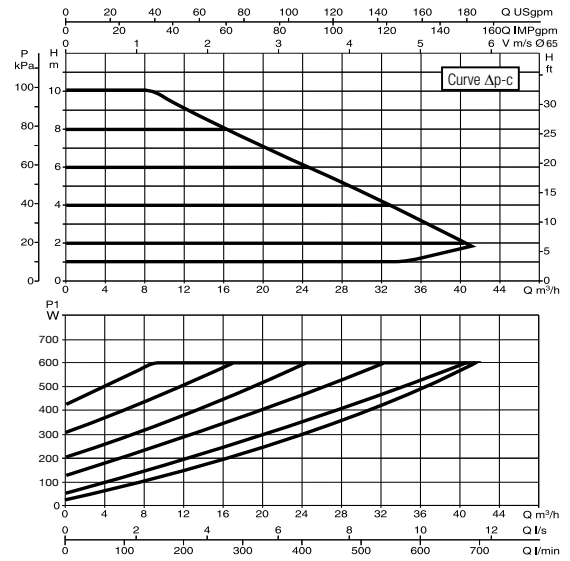
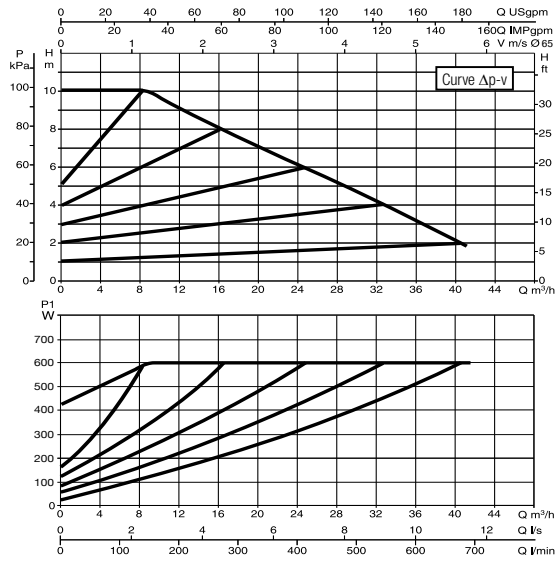

EVOPLUS B 120/340.65 M

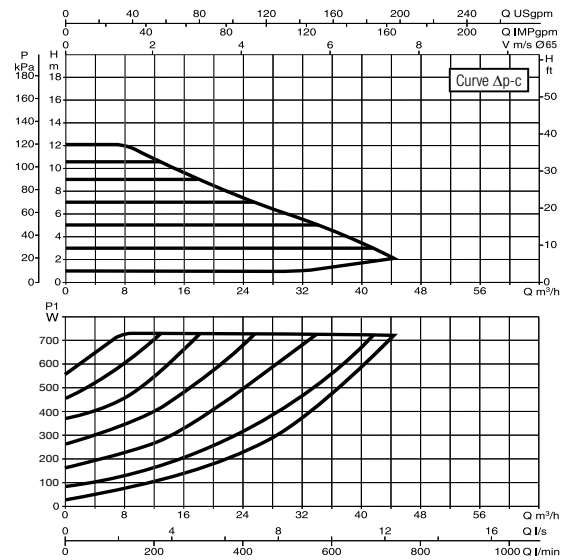
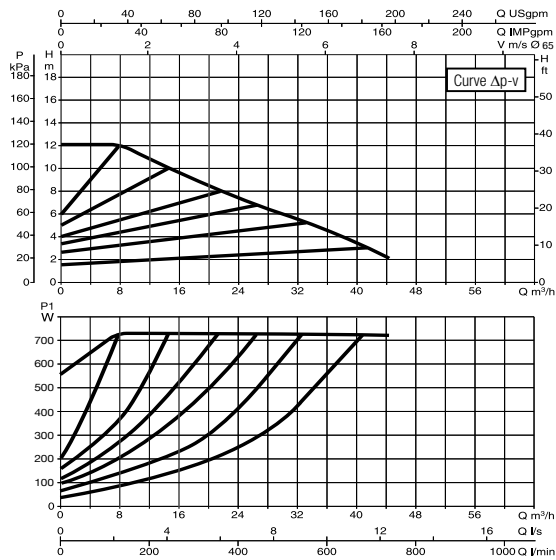

EVOPLUS B 150/340.65 M

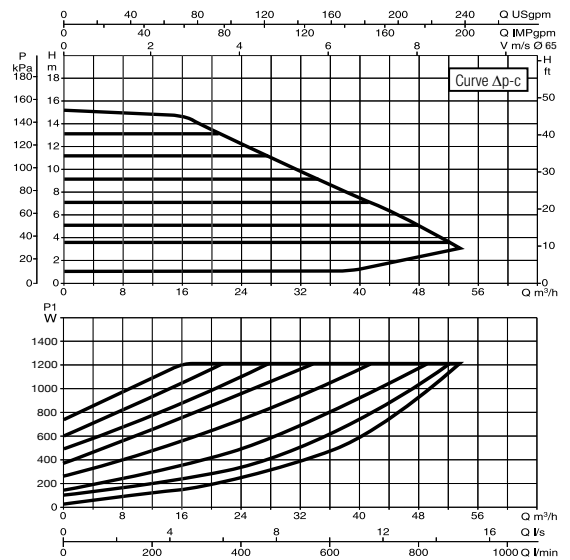
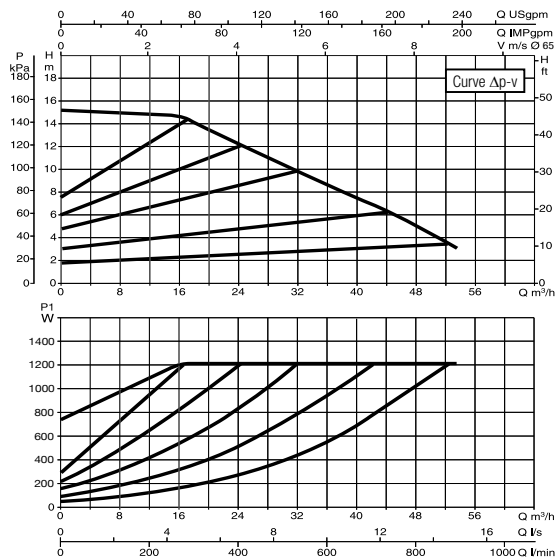

Curve tolerance according to ISO 9906.

HVAC

EVOPLUS

RANGE PERFORMANCE

EVOPLUS B 40/360.80 M

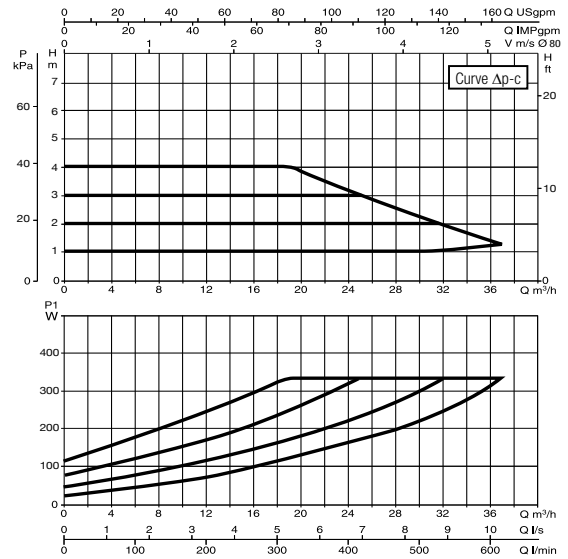
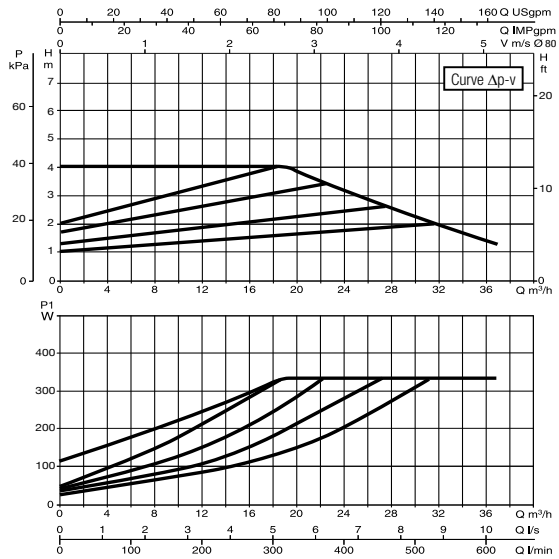

EVOPLUS B 60/360.80 M

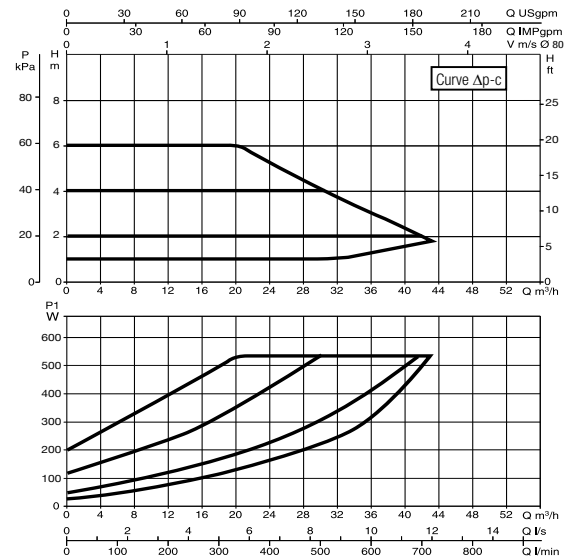
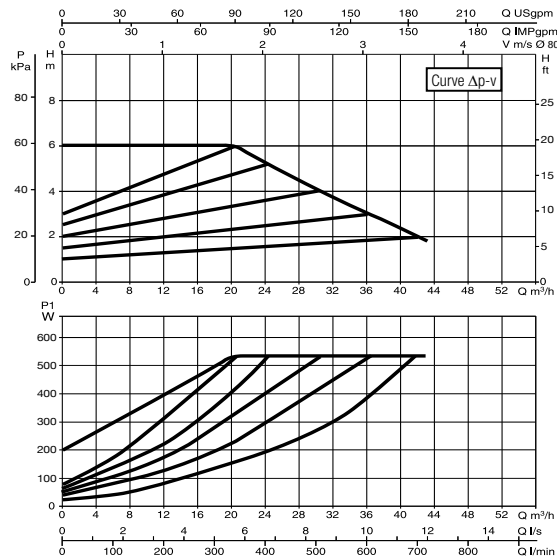

EVOPLUS B 80/360.80 M

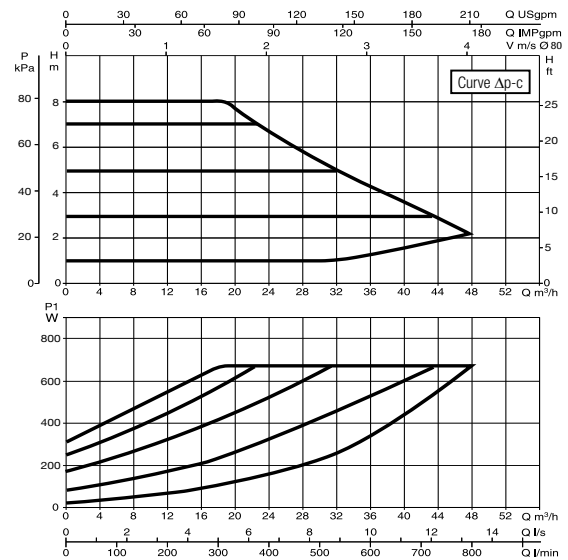
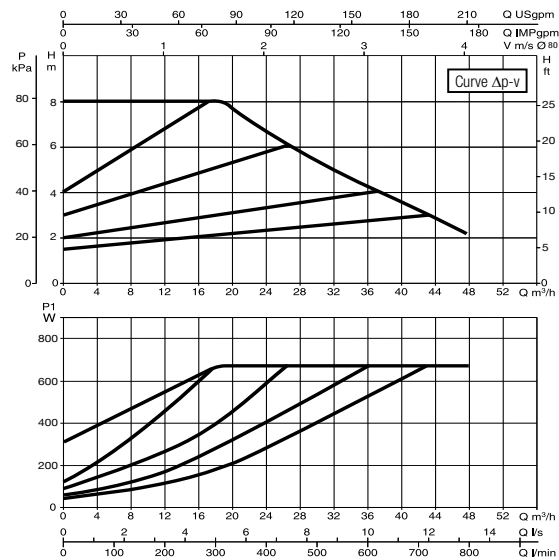

Curve tolerance according to ISO 9906.

EVOPLUS

RANGE PERFORMANCE

EVOPLUS B 100/360.80 M

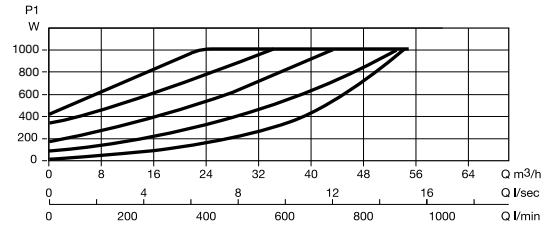
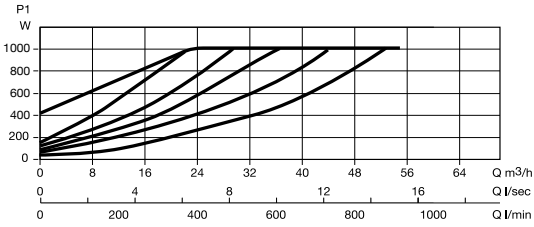
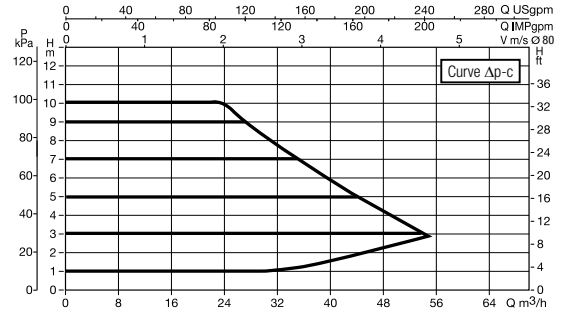
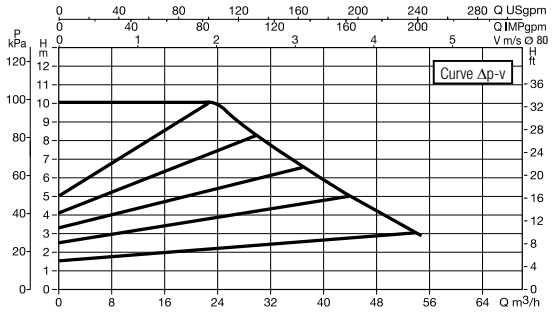

EVOPLUS B 120/360.80 M

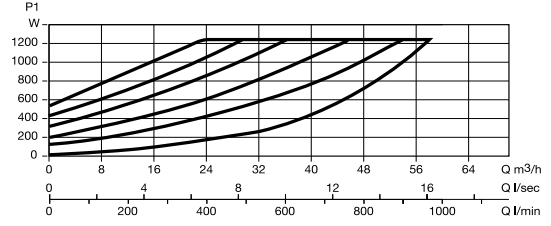
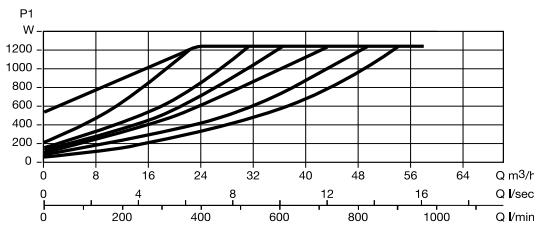
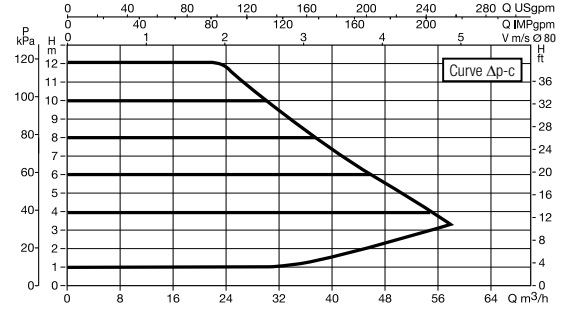
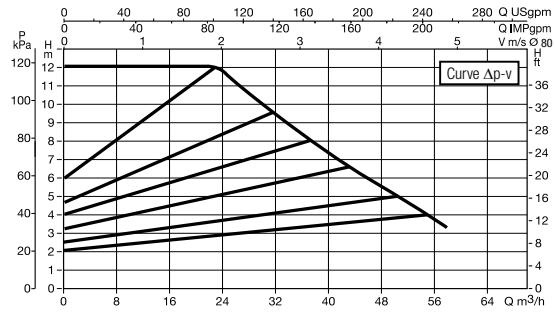

EVOPLUS B 40/450.100 M

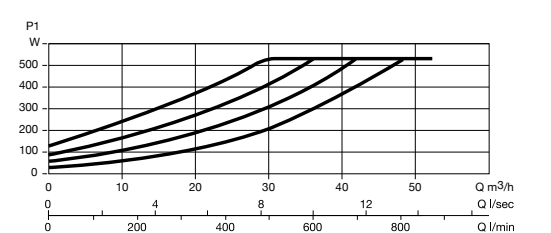
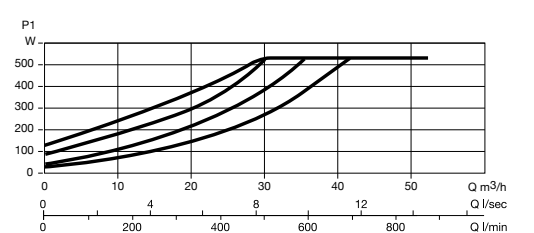
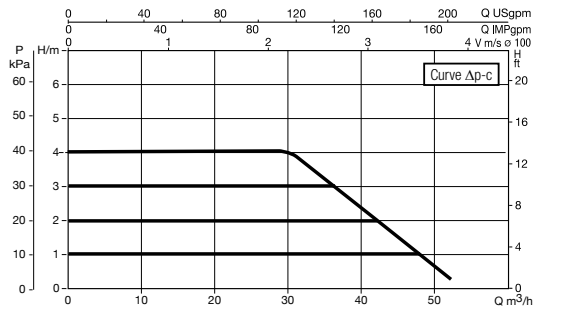
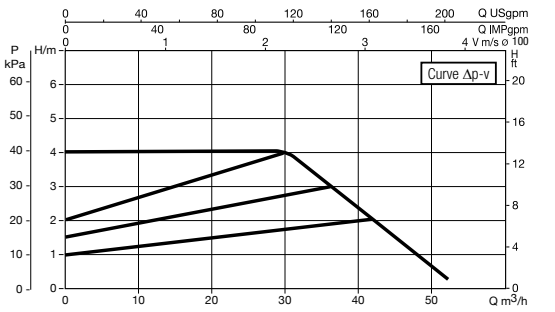

Curve tolerance according to ISO 9906.

HVAC

EVOPLUS

RANGE PERFORMANCE

EVOPLUS B 60/450.100 M

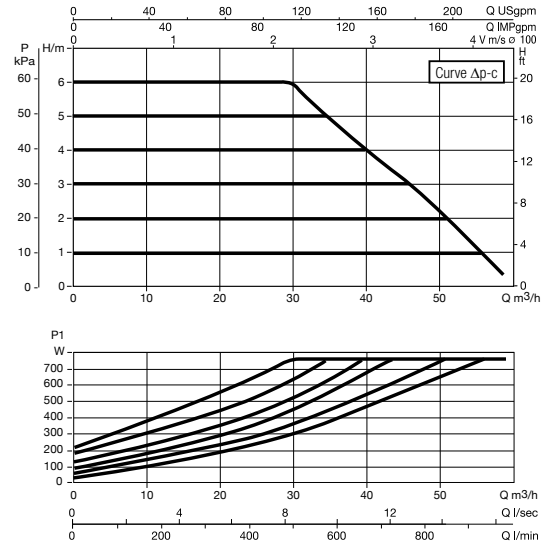
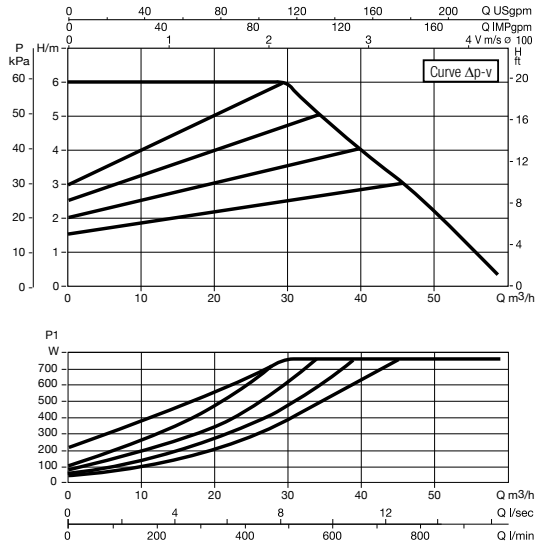

EVOPLUS B 80/450.100 M

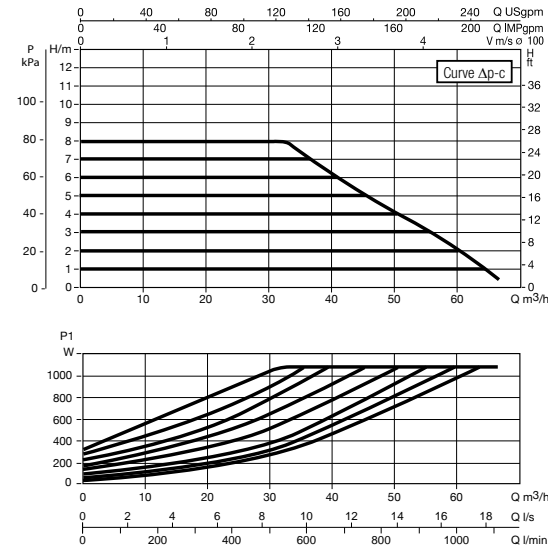
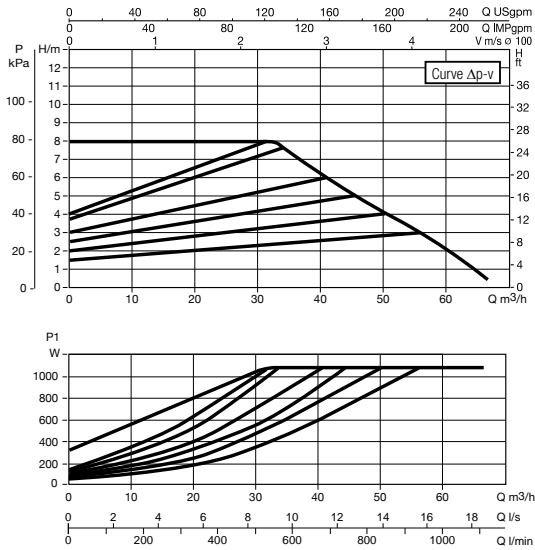

EVOPLUS B 100/450.100 M

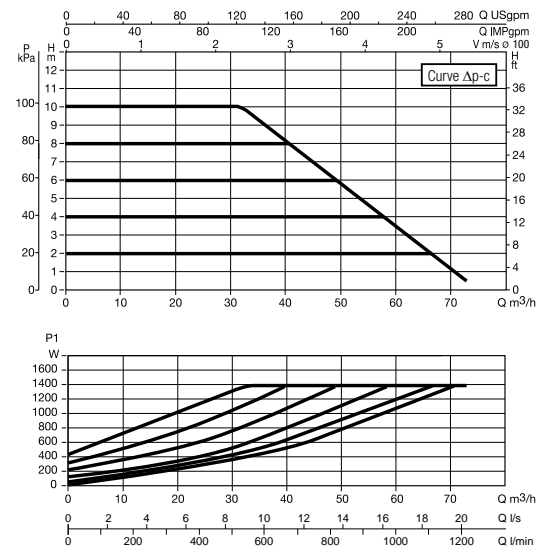
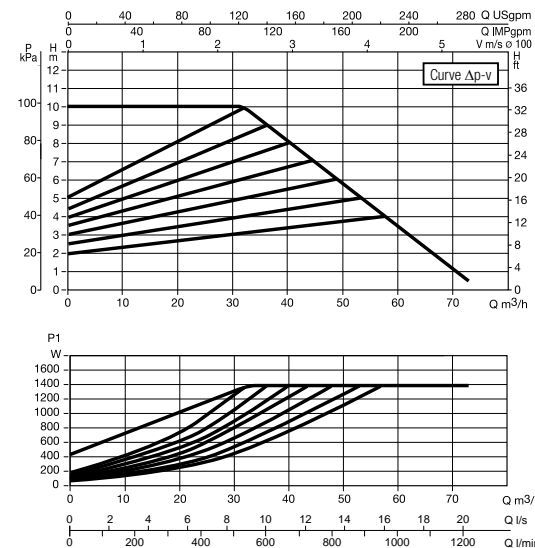

Curve tolerance according to ISO 9906.



DAB PUMPS reserves the right to make modifications without notice

HVAC

EVOPLUS

RANGE PERFORMANCE

EVOPLUS B 120/450.100 M

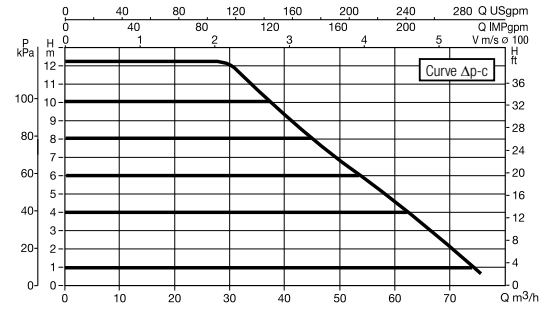
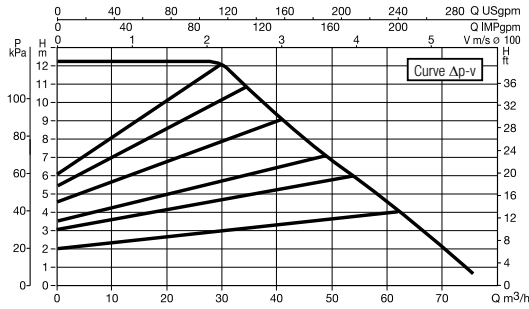

EVOPLUS D 120/220.32 M

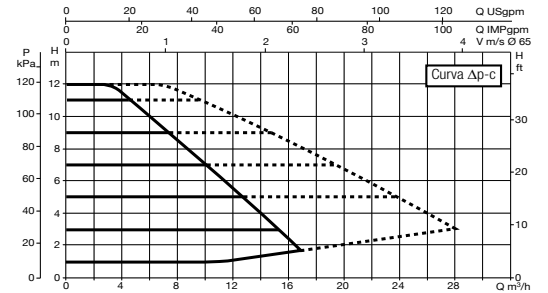
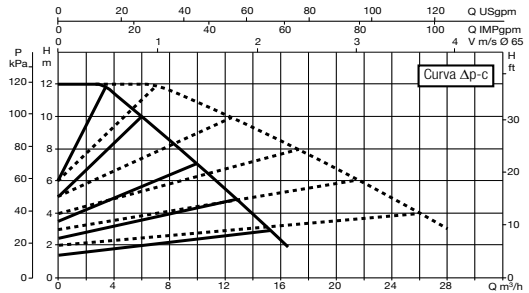

EVOPLUS D 40/220.40 M

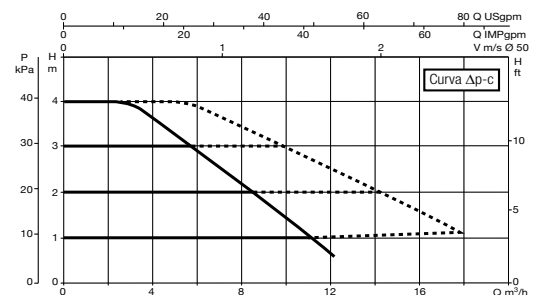
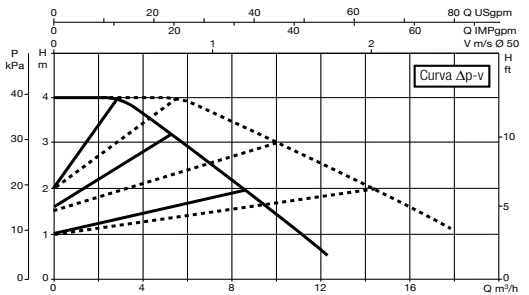

HVAC

Curve tolerance according to ISO 9906.

EVOPLUS

RANGE PERFORMANCE

EVOPLUS D 60/220.40 M

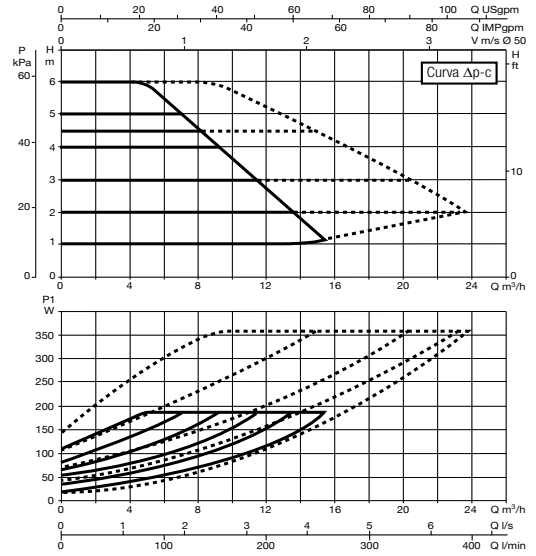
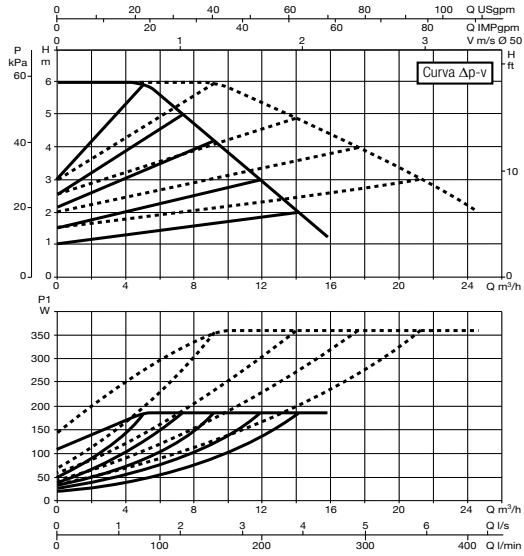

EVOPLUS D 80/220.40 M

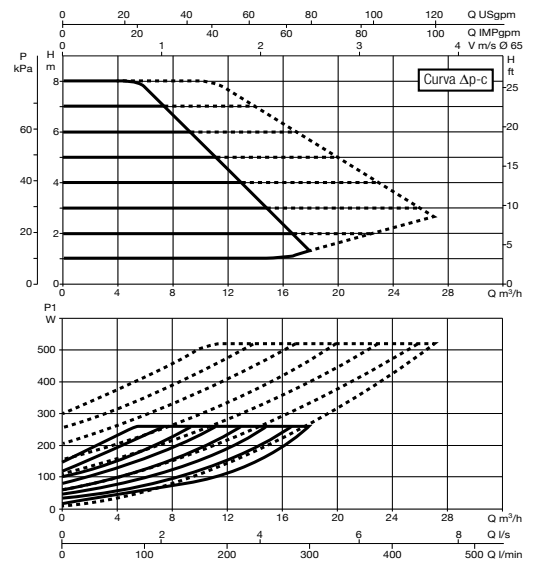
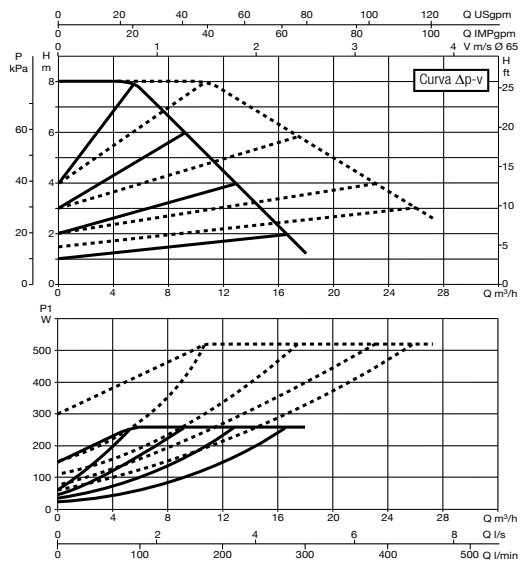

EVOPLUS D 100/220.40 M

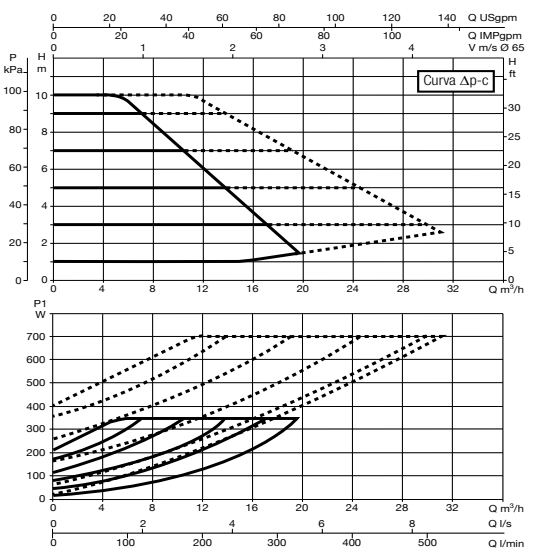
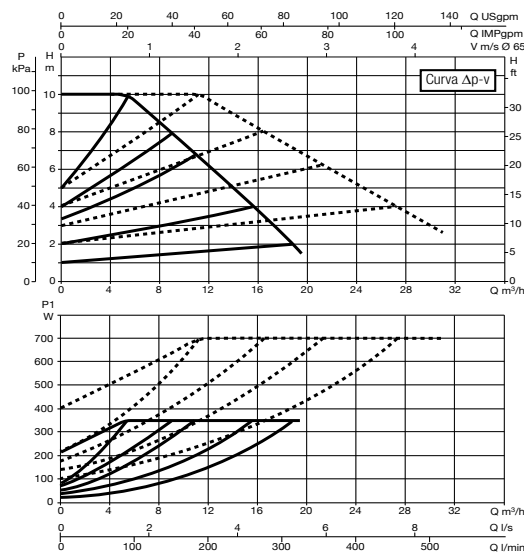

Curve tolerance according to ISO 9906.

EVOPLUS

RANGE PERFORMANCE

EVOPLUS D 120/250.40 M

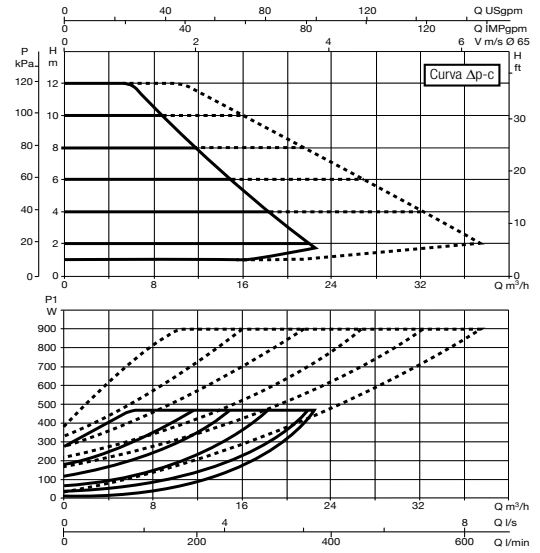
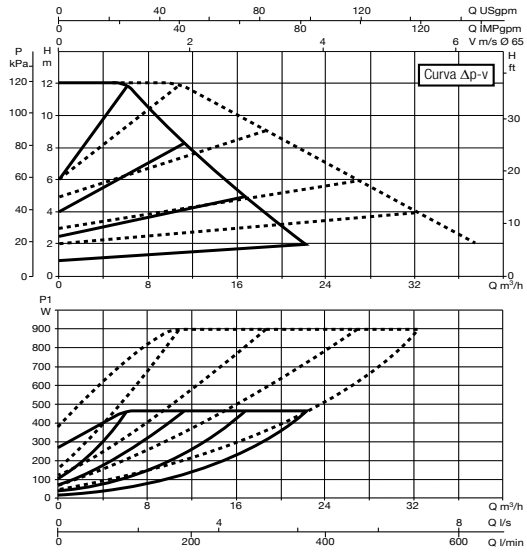

EVOPLUS D 150/250.40 M

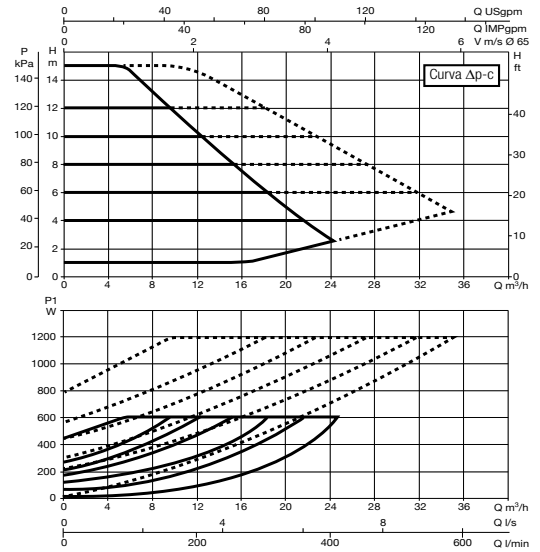
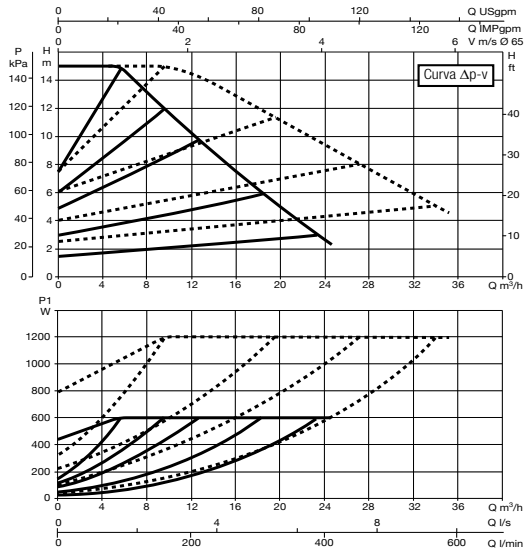

EVOPLUS D 180/250.40 M

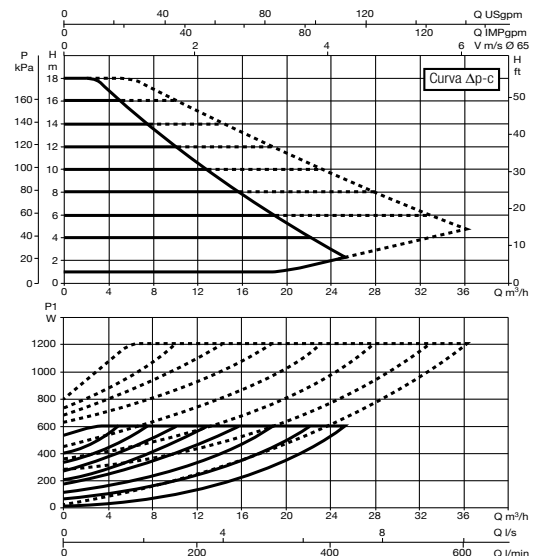
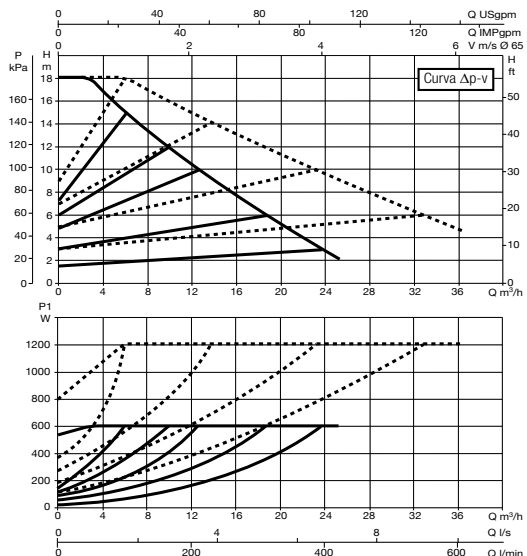

HVAC

Curve tolerance according to ISO 9906.

EVOPLUS

RANGE PERFORMANCE

EVOPLUS D 40/240.50 M

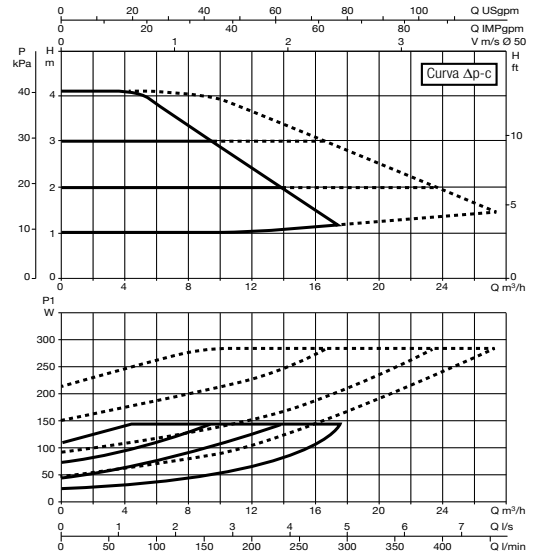
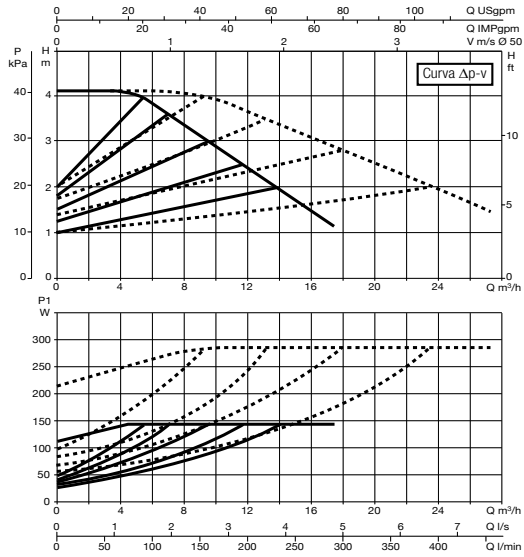

EVOPLUS D 60/240.50 M

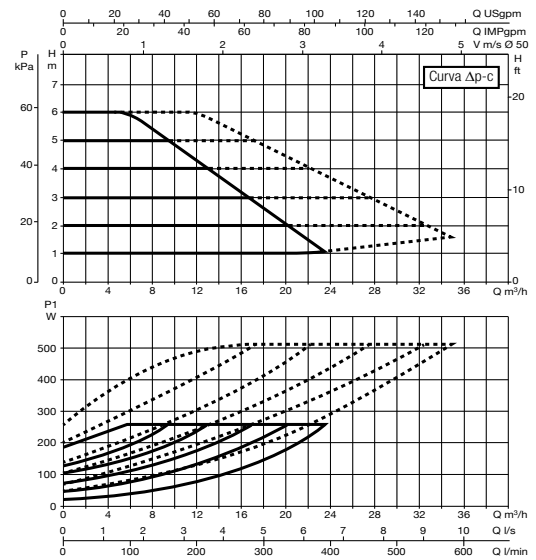
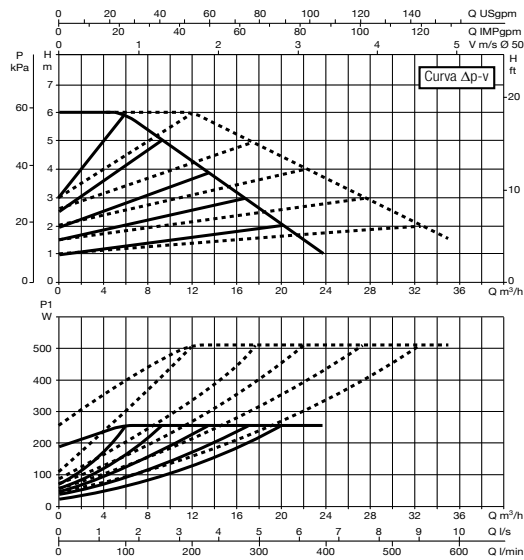

EVOPLUS D 80/240.50 M

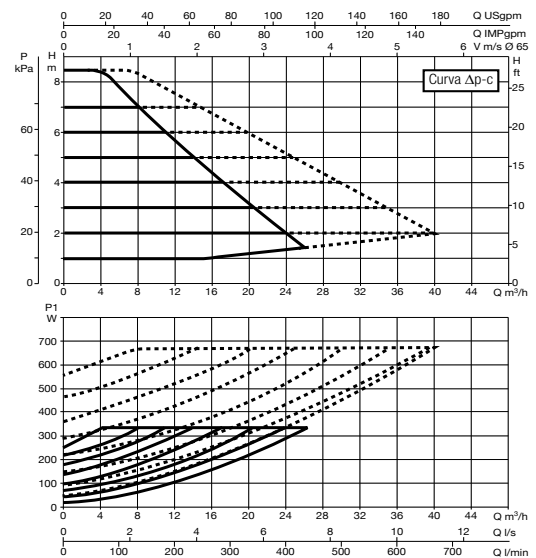
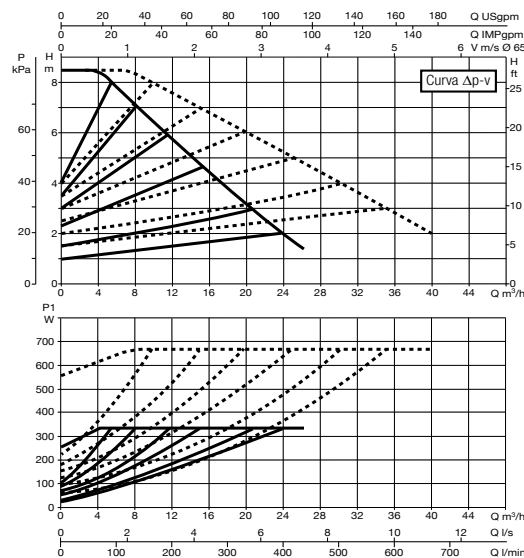

Curve tolerance according to ISO 9906.

EVOPLUS

RANGE PERFORMANCE

EVOPLUS D 100/280.50 M

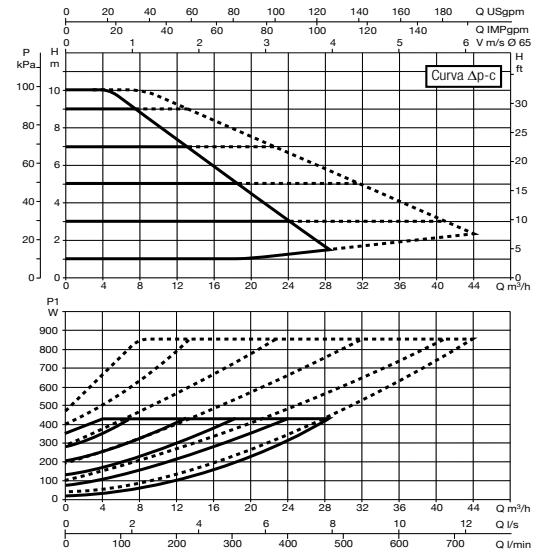
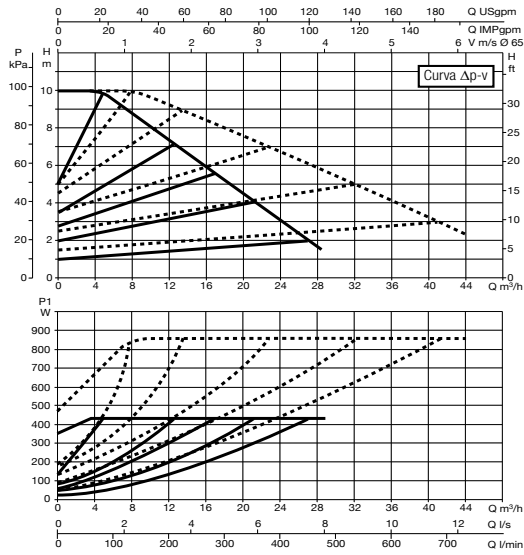

EVOPLUS D 120/280.50 M

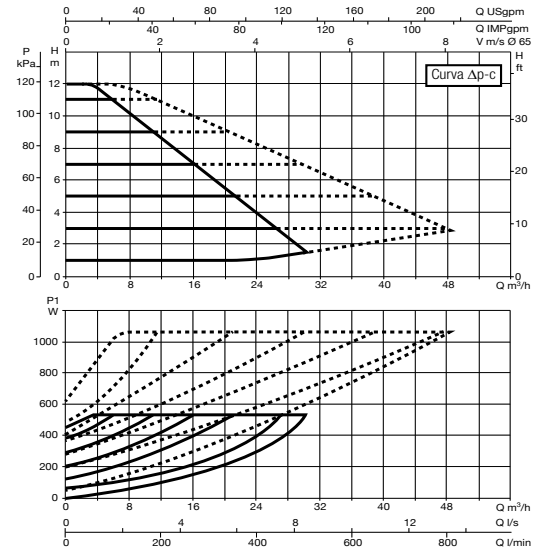
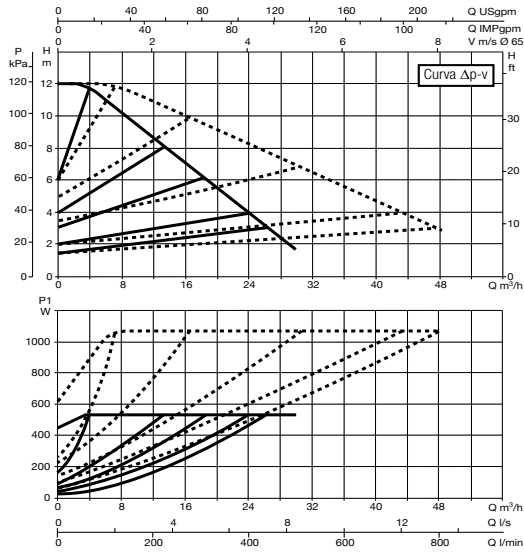

EVOPLUS D 150/280.50 M

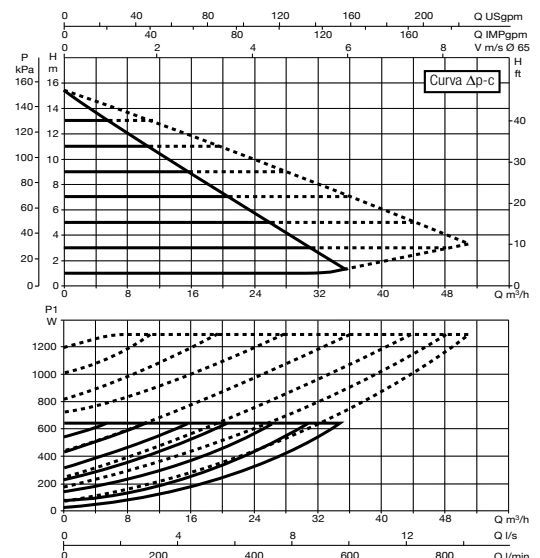
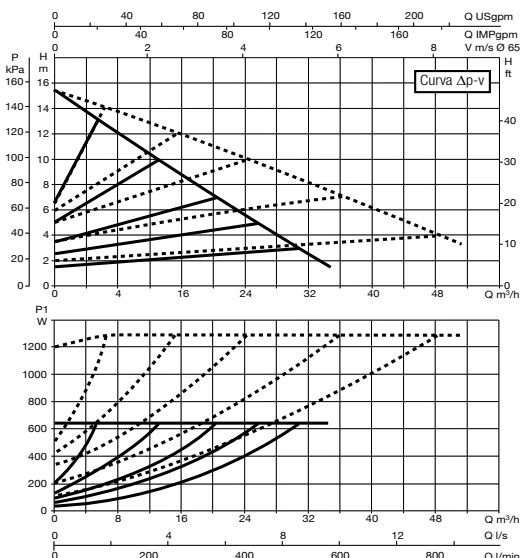

HVAC

Curve tolerance according to ISO 9906.

EVOPLUS

RANGE PERFORMANCE

EVOPLUS D 180/280.50 M

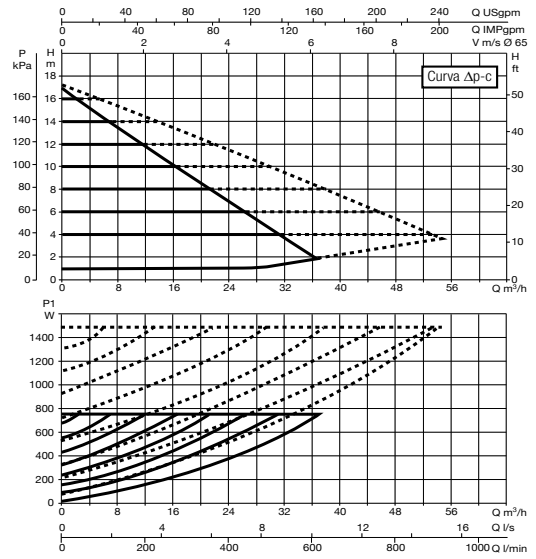
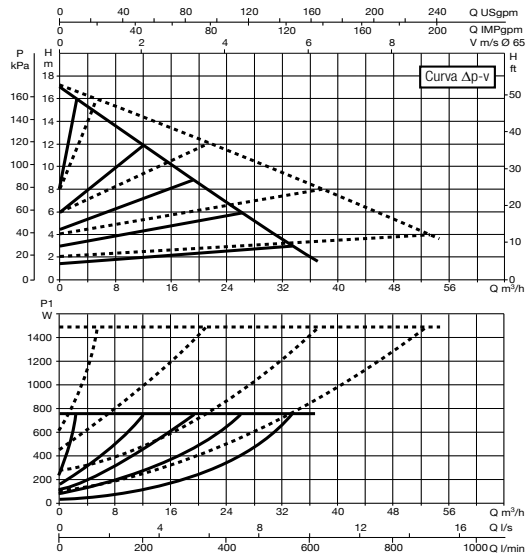

EVOPLUS D 40/340.65 M

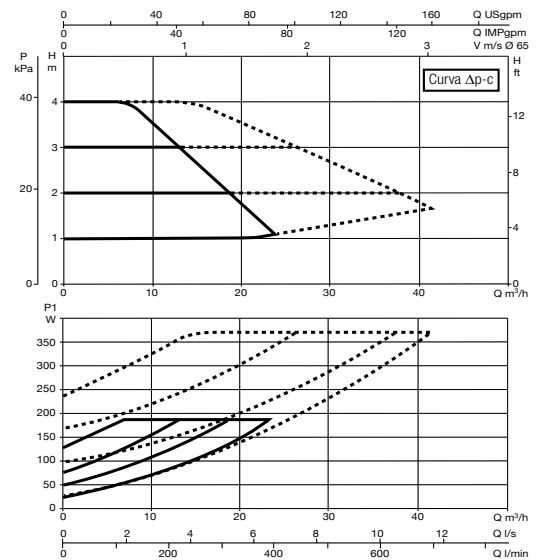
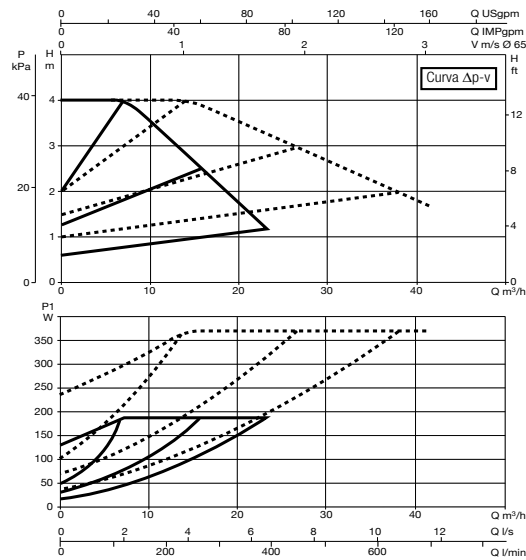

EVOPLUS D 60/340.65 M

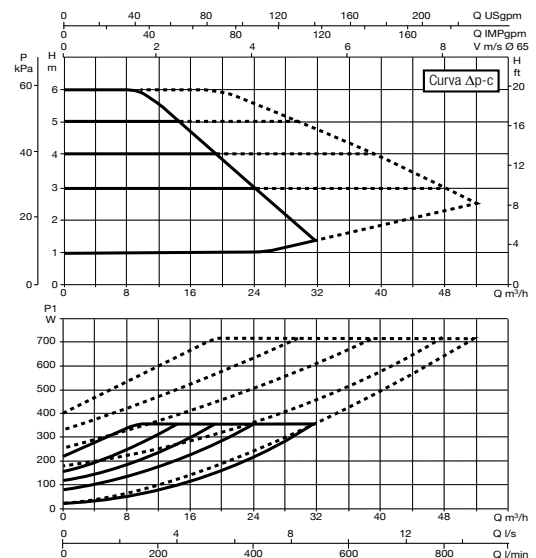
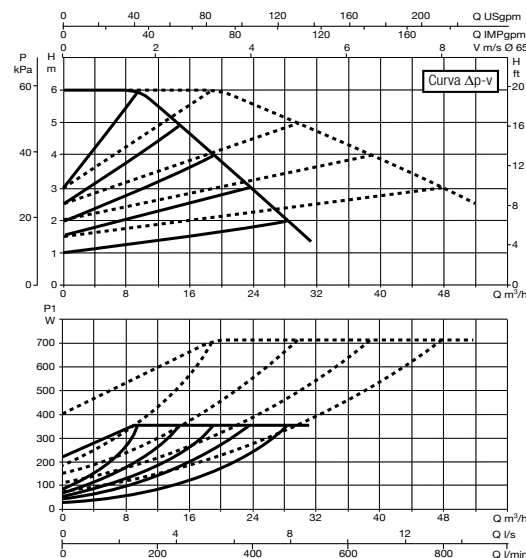

Curve tolerance according to ISO 9906.

EVOPLUS

RANGE PERFORMANCE

EVOPLUS D 80/340.65 M

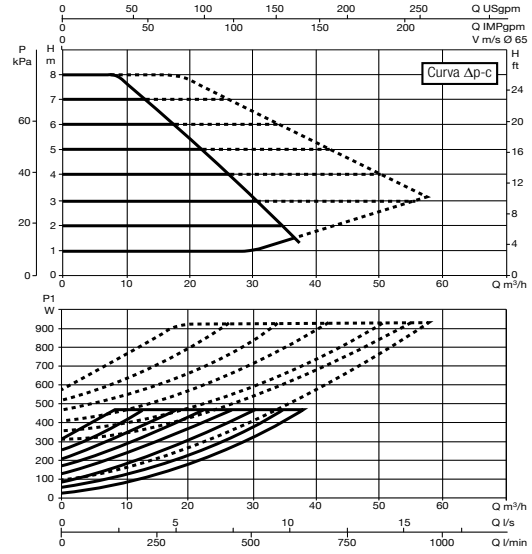
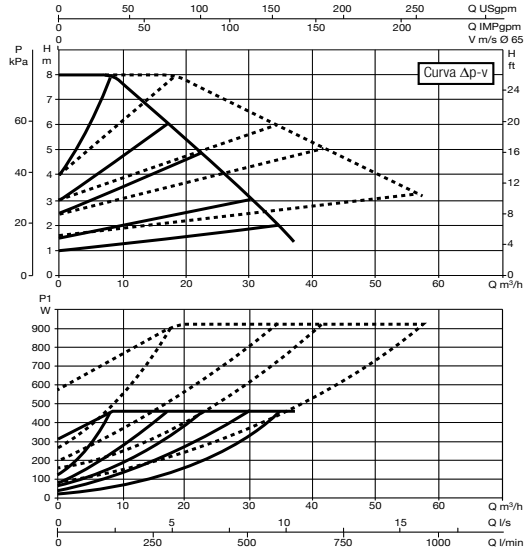

EVOPLUS D 100/340.65 M

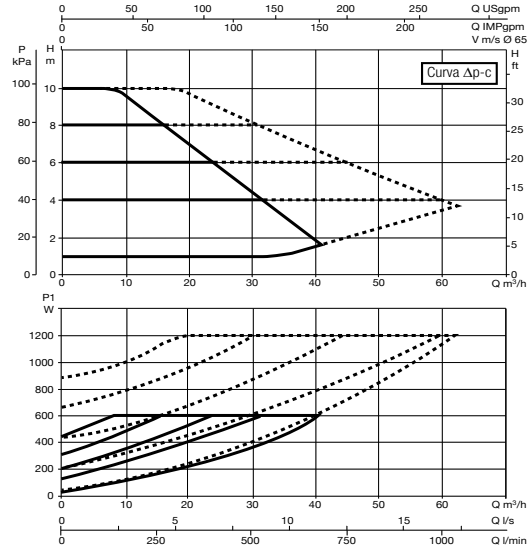
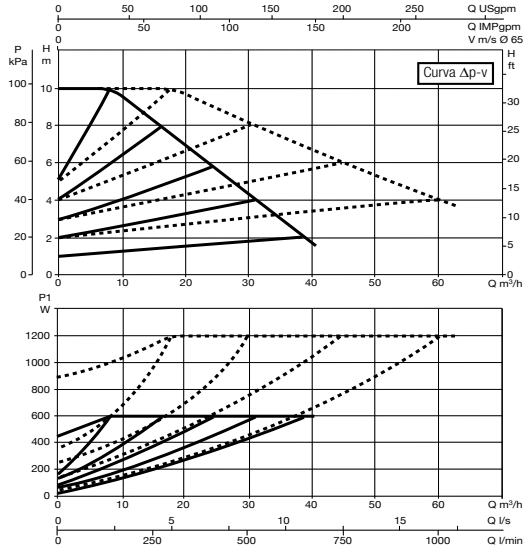

EVOPLUS D 120/340.65 M

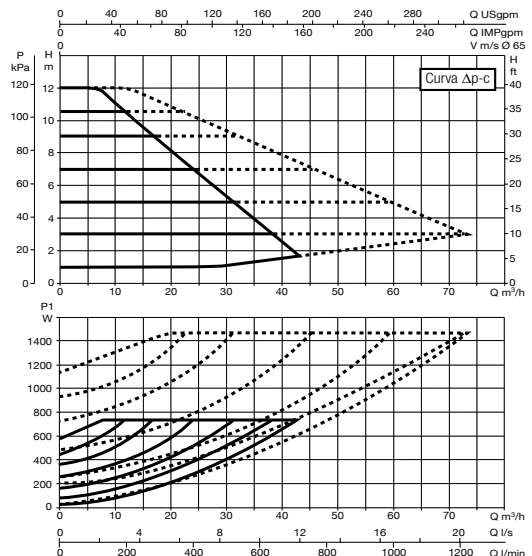
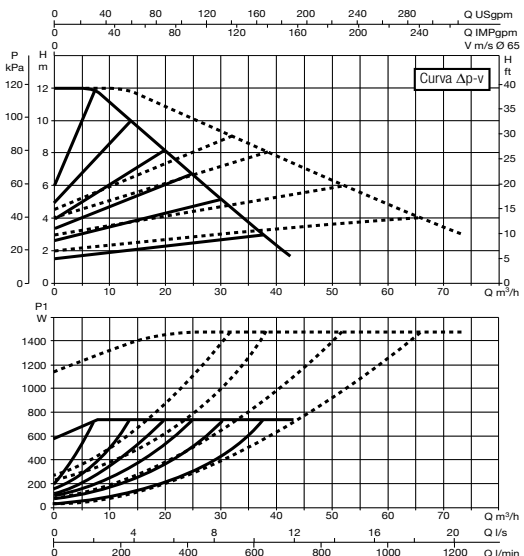

Curve tolerance according to ISO 9906.

HVAC

EVOPLUS

RANGE PERFORMANCE

EVOPLUS D 150/340.65 M

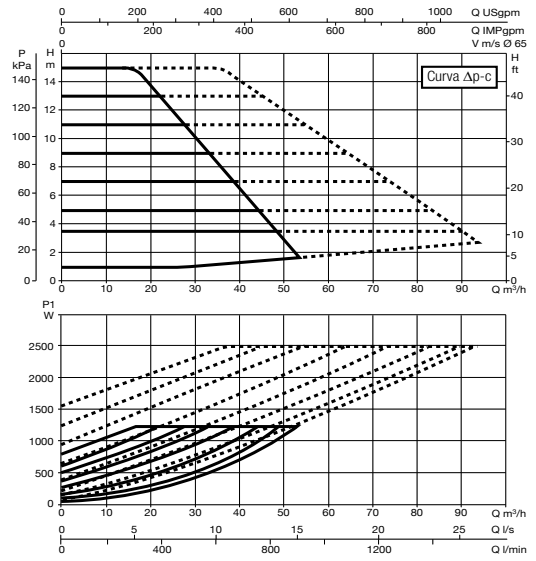
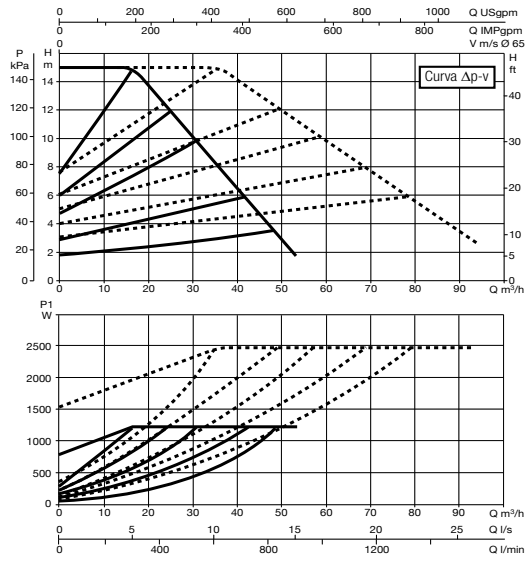

EVOPLUS D 40/360.80 M

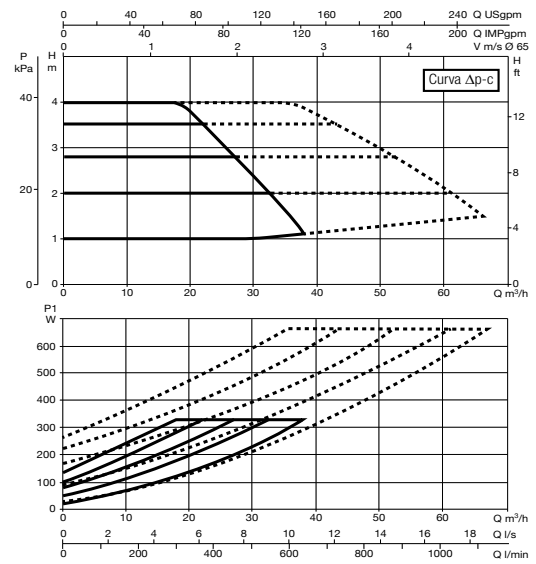
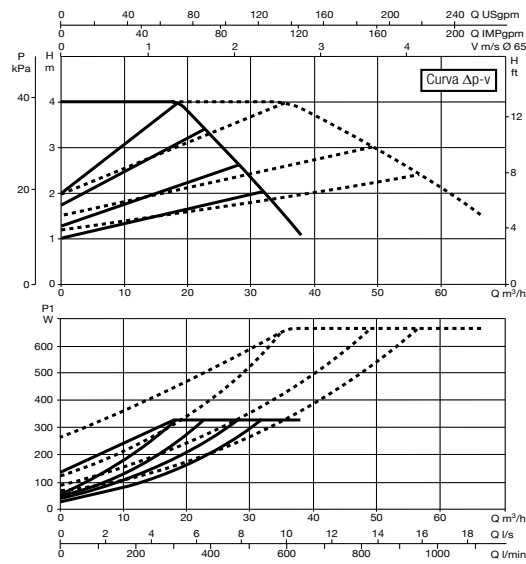

EVOPLUS D 60/360.80 M

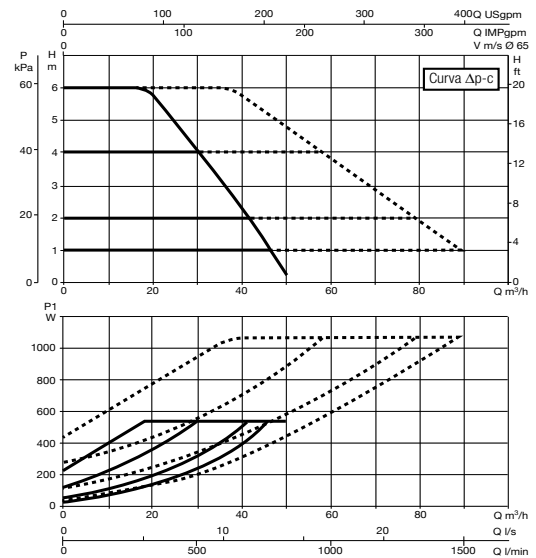
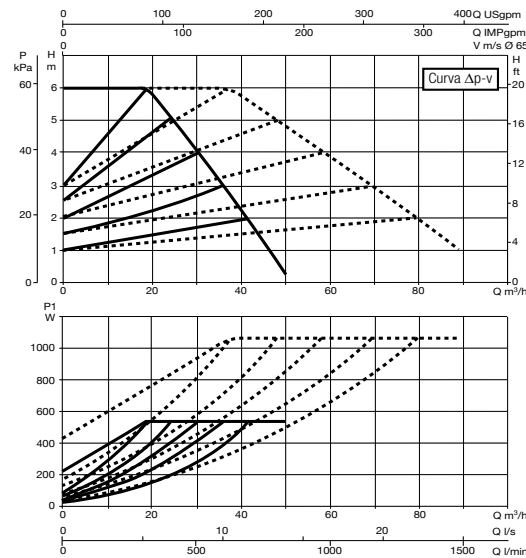

Curve tolerance according to ISO 9906.

EVOPLUS

RANGE PERFORMANCE

EVOPLUS D 80/360.80 M

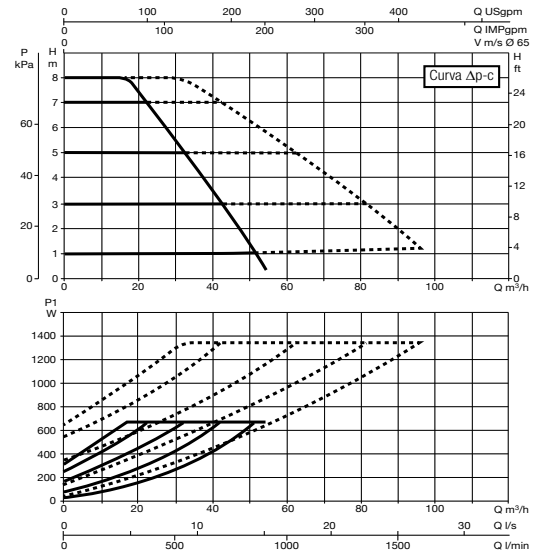
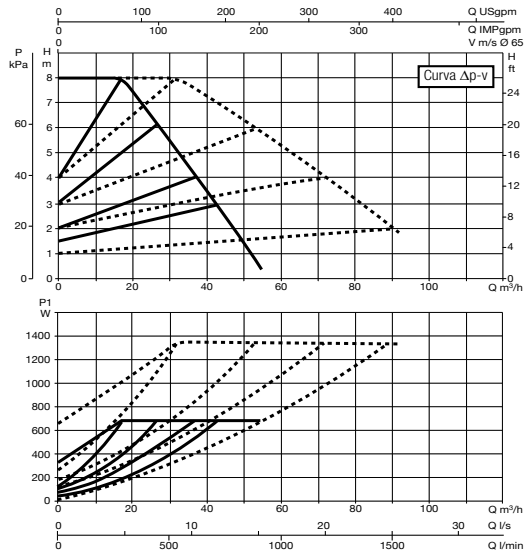

EVOPLUS D 100/360.80 M

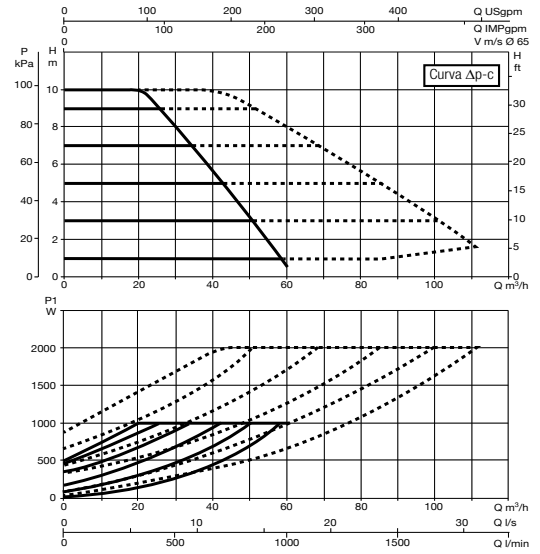
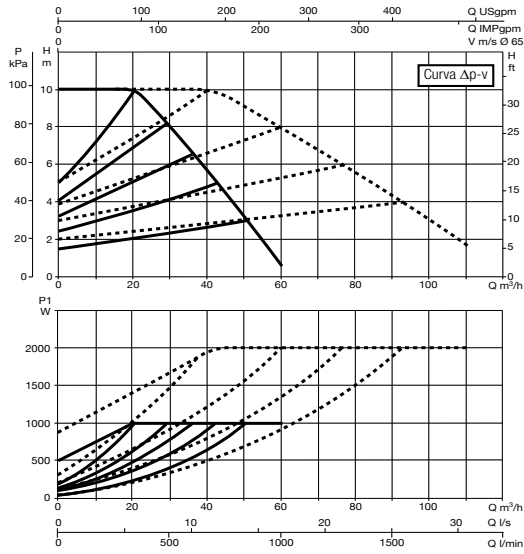

EVOPLUS D 120/360.80 M

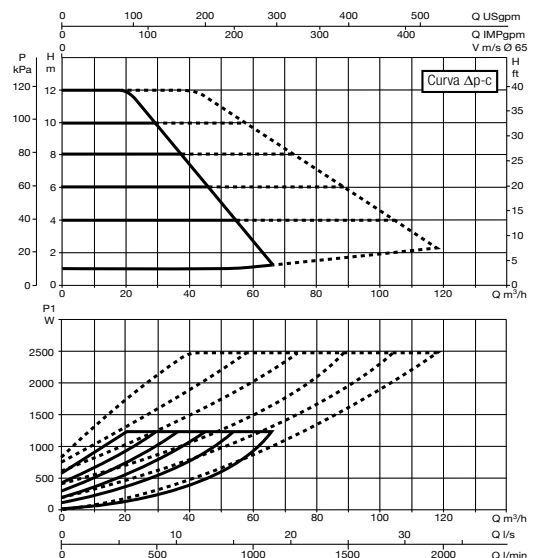
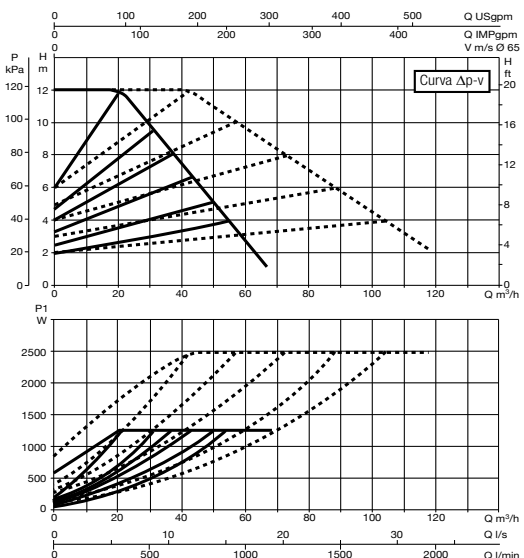

HVAC

Curve tolerance according to ISO 9906.

EVOPLUS

RANGE PERFORMANCE

EVOPLUS D 40/450.100 M

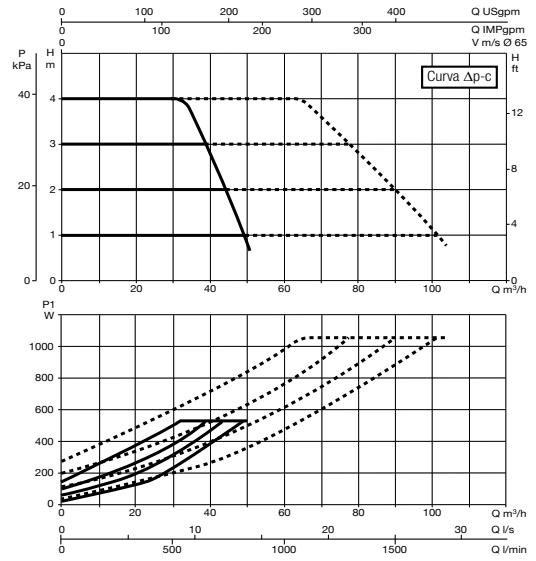
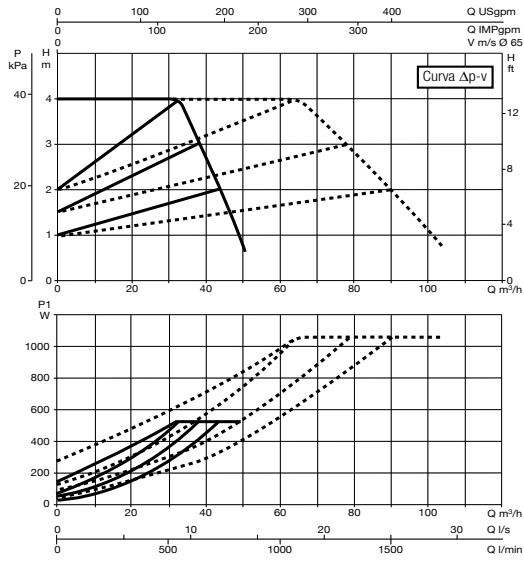

EVOPLUS D 60/450.100 M

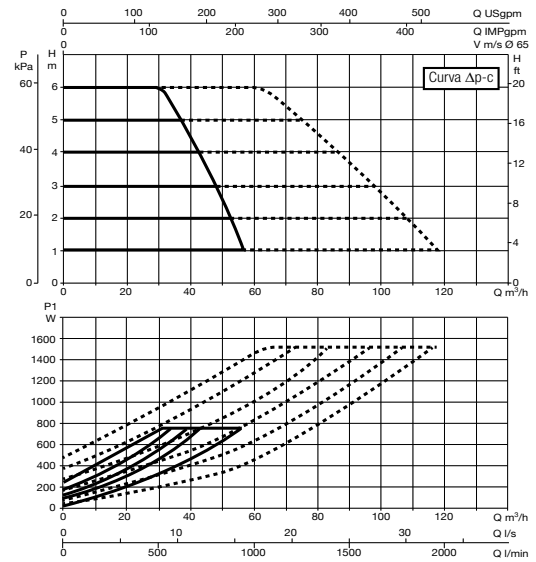
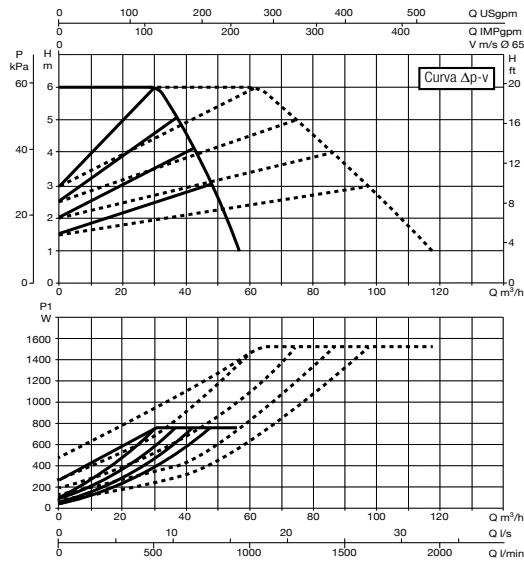

EVOPLUS D 80/450.100 M

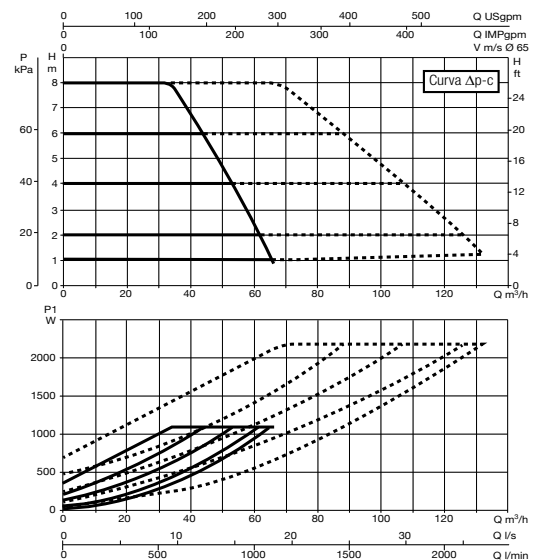
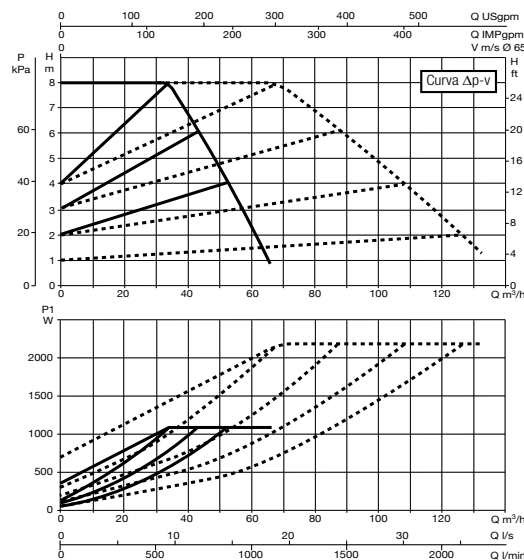

Curve tolerance according to ISO 9906.

EVOPLUS

RANGE PERFORMANCE

EVOPLUS D 100/450.100 M

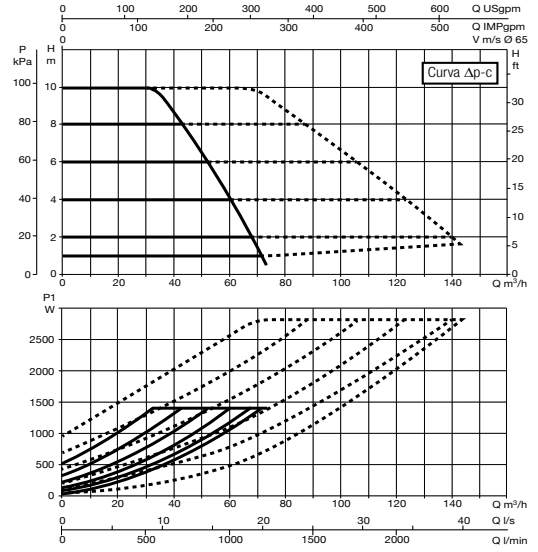
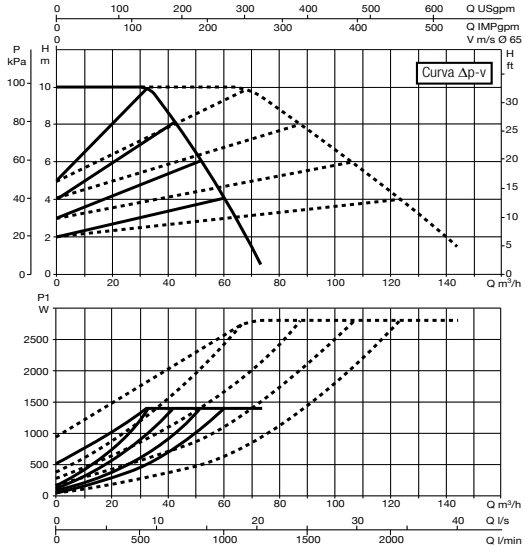

EVOPLUS D 120/450.100 M

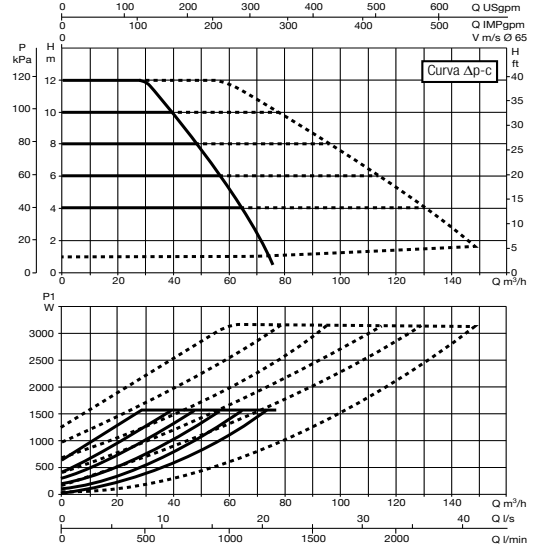
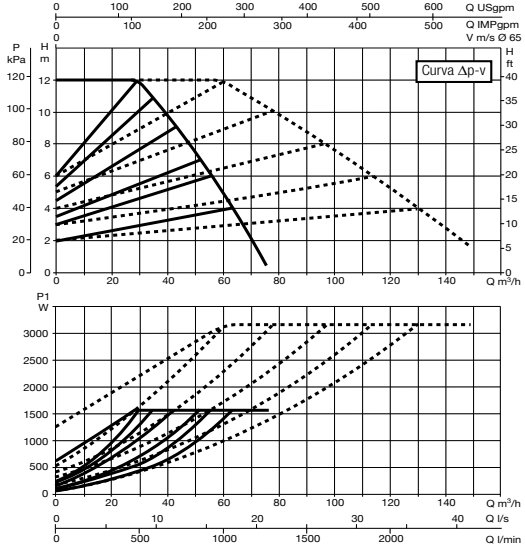

Curve tolerance according to ISO 9906.

EVOPLUS

CIRCULATORS FOR HEATING AND AIR-CONDITIONING SYSTEMS

DIMENSIONS AND WEIGHTS - EVOPLUS B

MODEL	L	L1	L2	A1	A2	B	B1	B2	D	D1	D2	D3	D4	H	H1	H2	WEIGHT lbs	Q.TY x PALLET
EVOPLUS B 120/220.32 M	8.7	4.3	4.3	0.7	0.6	16.4	3.7	12.7	5.5	3.9	3.5	3	1.4	8.7	8.7	10.7	30.9	16
EVOPLUS B .../220.40 M	8.7	4.3	4.3	0.7	0.6	16.5	3.7	12.8	5.9	4.3	3.9	3.3	1.7	8.7	8.7	10.7	34.2	16
EVOPLUS B .../250.40 M	9.8	4.9	4.9	0.7	0.6	16.5	3.7	12.8	5.9	4.3	3.9	3.3	1.7	9.1	8.7	10.7	35.3	16
EVOPLUS B .../240.50 M	9.4	4.7	4.7	0.7	0.6	16.3	3.4	12.8	6.5	4.9	4.3	3.9	2.1	8.7	8.7	10.7	37.5	16
EVOPLUS B .../280.50 M	11	5.5	5.5	0.7	0.6	16.3	3.4	12.8	6.5	4.9	4.3	3.9	2.1	9.1	8.7	10.7	39.7	16
EVOPLUS B .../340.65 M	13.4	6.7	6.7	0.7	0.6	17.4	4.3	13.1	7.3	5.7	5.1	4.6	2.7	11	8.7	10.7	44.1	8
EVOPLUS B .../360.80 M	14.2	7.1	7.1	0.7	-	17.6	4.2	13.4	7.9	6.3	-	5.2	3.1	11	8.7	10.7	55.1	8
EVOPLUS B .../450.100 M	17.7	8.9	8.9	0.7	-	18.2	4.3	13.9	8.7	7.1	-	6.1	4.1	11.5	8.7	10.7	66.1	4

EVOPLUS D

MODEL	L	L1	L2	A1	A2	B	B1	B2	D	D1	D2	D3	D4	I	I1	I2	I3	M	H	H1	H2	H3	H4	WEIGHT lbs	Q.TY x PALLET
EVOPLUS D 120/220.32 M	8.7	-	-	0.7	0.6	15.4	2.7	12.7	5.5	3.9	3.5	3	1.4	5.1	5.1	3.8	1.6	M0.5	16.5	18.9	12.7	8.2	8.3	63.9	4
EVOPLUS D .../220.40 M	8.7	-	-	0.7	0.6	17.2	3	14.2	5.9	4.3	3.9	3.3	1.7	5.1	5.1	2.1	3.1	M0.5	17.2	18.9	11.3	8.6	8.6	68.3	4
EVOPLUS D .../250.40 M	9.8	-	-	0.7	0.6	15.6	2.7	12.8	5.9	4.3	3.9	3.3	1.7	5.1	5.1	2.3	3.2	M0.5	17.9	18.9	10.8	9	8.9	70.5	4
EVOPLUS D .../240.50 M	9.4	-	-	0.7	0.6	15.7	3	12.8	6.5	4.9	4.3	3.9	2.1	5.1	5.1	1.9	4.5	M0.5	18.2	18.9	12.5	9.2	9.1	72.8	4
EVOPLUS D .../280.50 M	11	-	-	0.7	0.6	15.7	3	12.8	6.5	4.9	4.3	3.9	2.1	5.1	5.1	4.9	2	M0.5	18.4	18.9	10.7	9.3	9.1	75	4
EVOPLUS D .../340.65 M	13.4	7.9	5.5	0.7	0.6	16.2	3	13.1	7.3	5.7	5.1	4.6	2.7	5.1	5.1	6.7	1.9	M0.5	19.1	18.9	10.7	9.8	9.3	81.6	4
EVOPLUS D .../360.80 M	14.2	7.9	6.3	0.7	-	17.2	3.8	13.4	7.9	6.3	-	5.2	3.1	5.1	5.1	6.3	2.3	M0.5	20.3	18.9	10.7	10.3	10	97	4
EVOPLUS D .../450.100 M	17.7	10.2	7.5	0.7	-	18	4.1	13.9	8.7	7.1	-	6.1	4.1	5.3	5.3	7.9	1.7	M0.5	20.4	19.3	10.7	10.4	9.9	116.8	4

EVOPLUS B

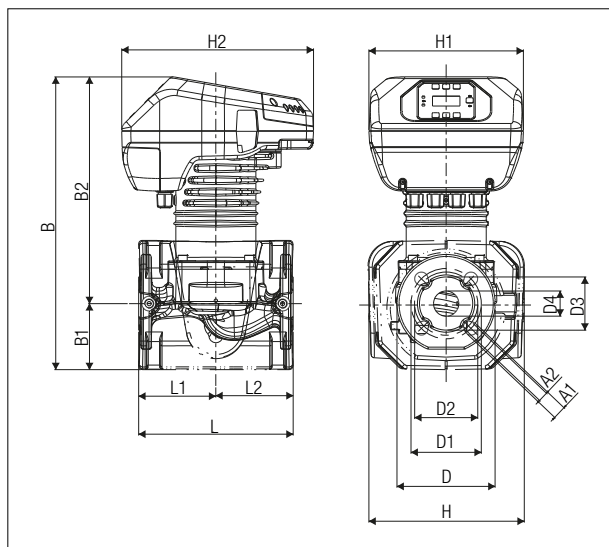

EVOPLUS D

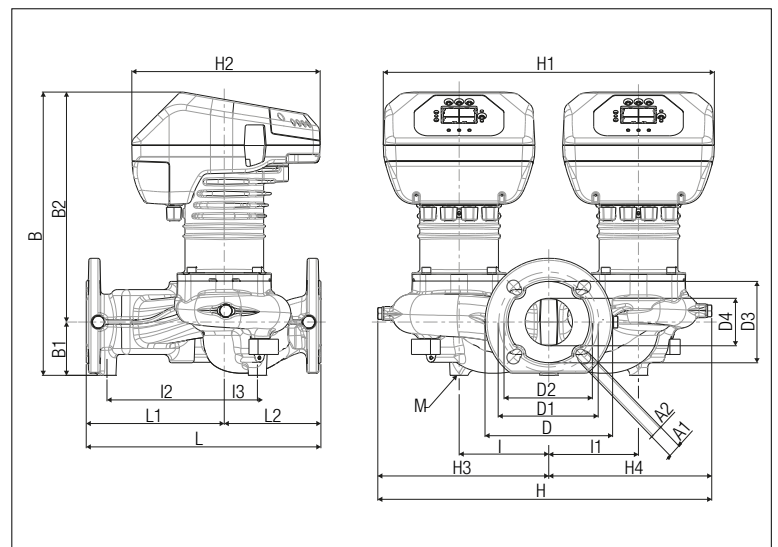

ACCESSORIES HVAC

ACCESSORIES

CIRCULATORS AND IN-LINE PUMPS

BLANK FLANGE KIT	DESCRIPTION	CODE	MODEL	WEIGHT lbs
	BLANK FLANGE KIT - EVOPLUS S (std. feature in the twin version)	60153741	EVOPLUS SMALL	10.4
	DN 32 PN 10 AISI 304 BLANK FLANGE KIT EVOPLUS M&L (std. feature in the twin version)	60164747	EVOPLUS MEDIUM & LARGE SAN	10.4

REMOTE CONTROL MODULE	DESCRIPTION	CODE	MODEL	WEIGHT lbs
	EVOPLUS SMALL BASIC MODULE	60152883	EVOPLUS SMALL (All models) EVOPLUS SMALL SAN (All models)	1.1
	EVOPLUS SMALL MULTI-FUNCTION MODULE	60152884	EVOPLUS SMALL (All models) EVOPLUS SMALL SAN (All models) Supplied with Evoplus Small Twin models	1.1
	EVOPLUS SMALL MULTI-FUNCTION MODULE SN > 2	60201084	EVOPLUS SMALL (All models) EVOPLUS SMALL SAN (All models) Supplied with Evoplus Small Twin models	1.1

BASIC MODULE

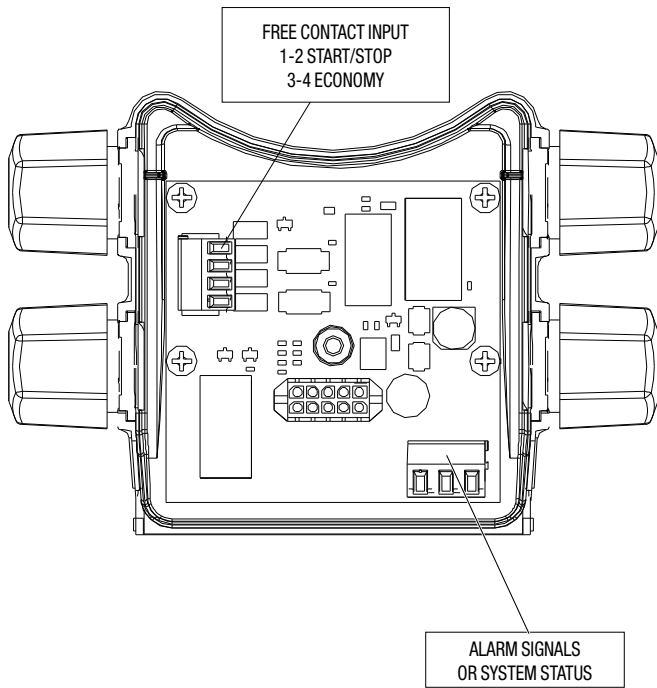

MULTI-FUNCTION MODULE

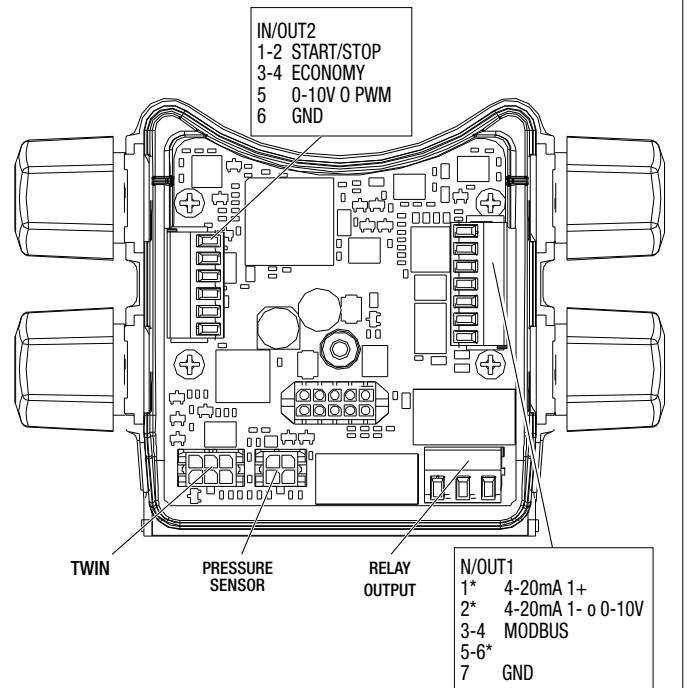



ESWIM
ELECTRONIC SWIMMING POOL PUMPS

PAGE 208



EUROCOM SP - JETCOM SP
SWIMMING POOL CENTRIFUGAL PUMPS

PAGE 214



EUROSWIM
SWIMMING POOL CENTRIFUGAL PUMPS

PAGE 211

▶ **ACCESSORIES**

PAGE 217

E.SWIM

ELECTRONIC SWIMMING POOL PUMPS



Electronic pumps with variable frequency drive for swimming pools and fish farms suitable for filtering salt or chlorine water in residential building service and commercial building service.

The pumps are quiet, programmable and equipped with a large inspectable pre-filter.

E.SWIM 150 and E.SWIM 150 SVRS have a 12-pin control card which makes them compatible with any control panel, both analog and digital. Lid of the pre-filter in transparent polycarbonate and in antioxidant material for an easy visual inspection. Permanent magnet synchronous motor, brushless. The motor is cooled by the pumped liquid, it is without cooling fan so the noise level is only 45 dB. Bayonet lid closure for E.SWIM, lid closure with wing screws for EPro. It is possible to remote control the pumps via 0-10 V, 4-20 mA and PWM signal. Thanks to the variable frequency drive, the pumps can operate at constant speed or with constant flow (without the use of sensors) to optimize performance and minimize energy consumption. The control panel has 4 buttons with 8 programmable speeds and status and alarm signaling LEDs. There is a menu for weekly and seasonal programming. The SVRS version is equipped with a software function that disables pump suction if an obstruction is detected. "SVRS" is an acronym that means Safety Vacuum Release Systems.

Flow rate maximum

150 versions: 140.9 GPM
300 versions: 187.6 GPM

Head up to

150 versions: 52 ft
300 versions: 85 ft

Type of pumped liquid clean or slightly dirty water with suspended solid bodies, long fibers; particularly aggressive water with high percentages of chlorine / bromine and PHMB (Polyhexamethylene Biguanide) or water treated with chlorine electrolysis process

PH RANGE 6.5 - 8.4

Max. supported liquid temperature +104°F

Maximum ambient temperature +122°F

Maximum operating pressure

150 versions: 36 psi
300 versions: 41 psi

Class of protection

150 versions: IP 55
300 versions: IP 56

Motor insulation class F

Impeller/s material techopolimer



Certified to NSF/ANSI Standard 50



ACCESSORIES
PAG. 217

TECHNICAL DATA

MODEL	CODE	ELECTRICAL DATA				HYDRAULIC DATA										DNA NPT	DNM NPT	WEIGHT lbs
		VOLTAGE 60 Hz	P1 MAX kW	P2 NOMINAL		In A	Q=GPM	0	26.4	52.8	79.2	92.4	105.6	118.8	132			
E.SWIM 150	60195697	230 V	1.25	1.1	1.5	5.6	H (ft)	52	52	47	40	36	31	26	21	2"	2"	41.9
E.SWIM 150 SVRS	60195698	230 V	1.25	1.1	1.5	5.6	H (ft)	52	52	47	40	36	31	26	21	2"	2"	41.9

MODEL	CODE	ELECTRICAL DATA				HYDRAULIC DATA										DNA NPT	DNM NPT	WEIGHT lbs		
		VOLTAGE 60 Hz	P1 MAX kW	P2 NOMINAL		In A	Q=GPM	0	22	44	66	88	110	132	154				176	187.4
E.SWIM 300	60198411	230 V	2.25	1.9	2.6	10	H (ft)	85	83	81	76	68	57	47	38	26	20	2"	2"	47

E.SWIM

ELECTRONIC SWIMMING POOL PUMPS

RANGE PERFORMANCE

E.SWIM 150

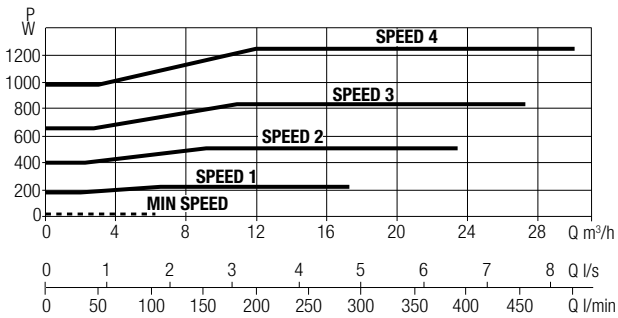
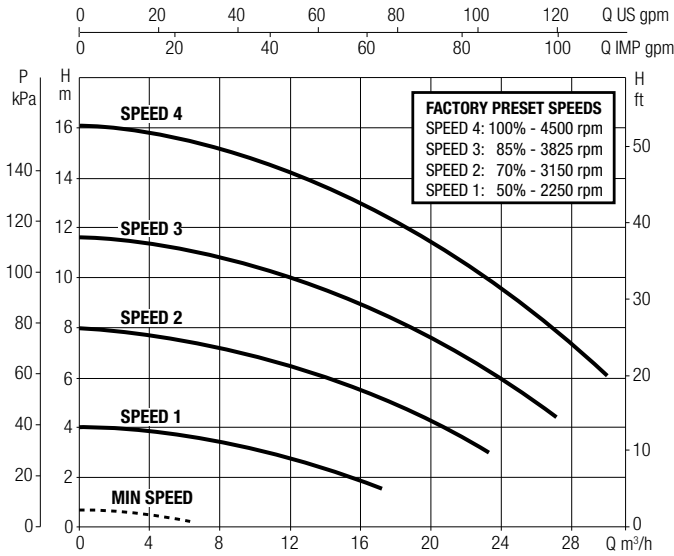

E.SWIM 300

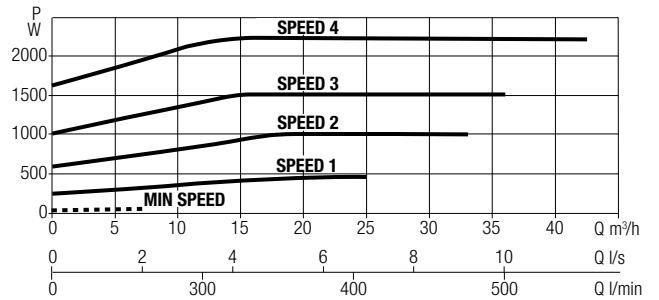
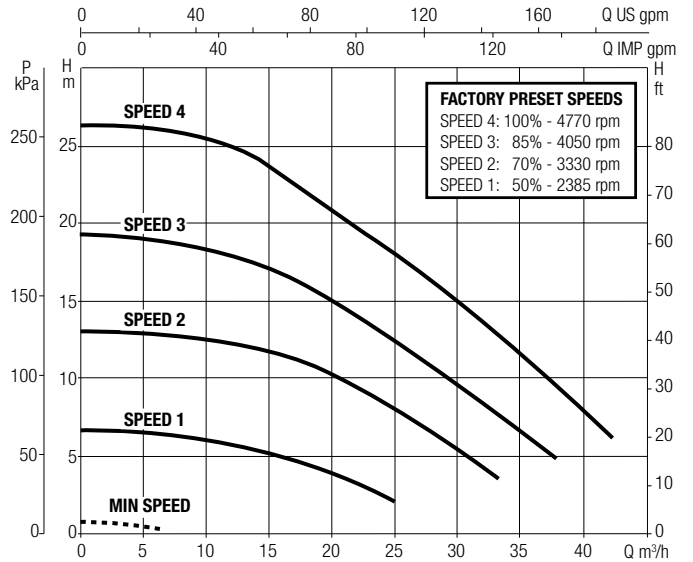

E.SWIM

ELECTRONIC SWIMMING POOL PUMPS

DIMENSIONS AND WEIGHTS

E.SWIM 150-300

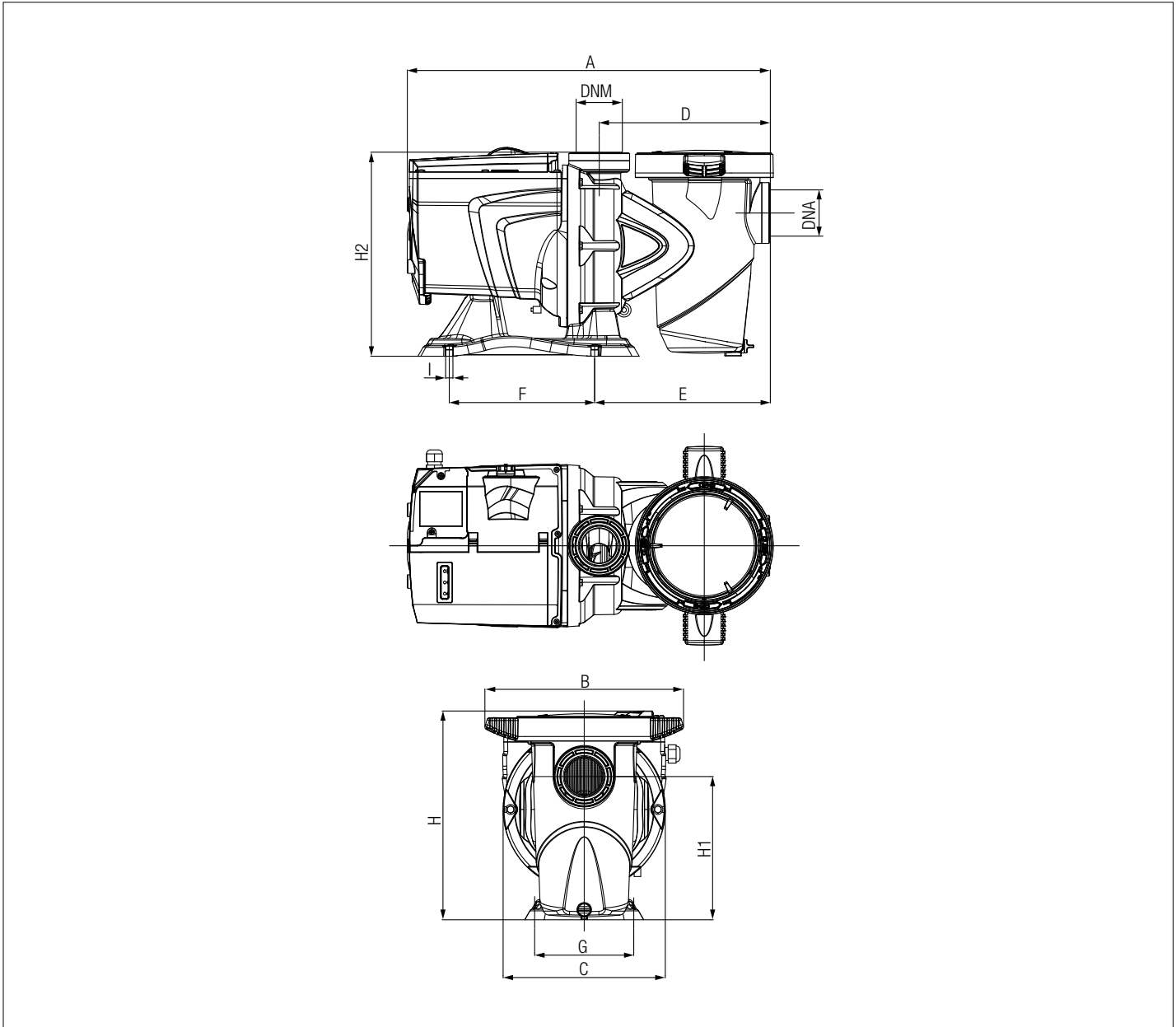

MODEL	A	B	C	D	E	F	G	H	H1	H2	I	DNA	DNM	PACKING DIMENSIONS			WEIGHT lbs	Q.TY x PALLET
														L/A	L/B	H		
E.SWIM 150	21.7	11.8	9.6	10.2	10.5	8.7	5.9	12.4	8.5	12.2	0.4	2" F	2" F	28.3	13.8	16.9	41.9	8
E.SWIM 150 SVRS	21.7	11.8	9.6	10.2	10.5	8.7	5.9	12.4	8.5	12.2	0.4	2" F	2" F	28.3	13.8	16.9	41.9	8
E.SWIM 300	22.6	12	11.4	10.6	10.9	8.7	5.9	13.9	9.9	13.5	0.4	2" F	2" F	28.3	13.8	16.9	47	6

EUROSWIM

SWIMMING POOL CENTRIFUGAL PUMPS



High efficiency self-priming centrifugal pumps with built-in large capacity prefilter. Extremely quiet running and great reliability, developed for water circulation and filtration in domestic and residential swimming pools. Suitable also for special applications that call for handling of aggressive liquids, in fish farms, agriculture and industry. Pump body in fibreglass reinforced technopolymer. Strainer cover in clear antioxidant polycarbonate to guarantee constant visibility through time. Nylon strainer. Impeller in fibreglass reinforced technopolymer developed to ensure total coverage and isolation of the motor shaft from the pumped liquid. Diffuser in reinforced technopolymer. Mechanical seal in carbon / alumina / NBR / AISI 316. Pump body O-rings in NBR, threaded fasteners and reinforcing rings in AISI 304. Butterfly drain plugs that can be removed and refitted without tools.

Asynchronous continuous duty 2-pole motor (S1) with generous range of power ratings from 0.5 HP to 3 HP, single phase and three-phase (see technical specifications). Motor casing in die cast aluminium with electrophoretic surface treatment to prevent oxidation even in aggressive environmental conditions. Baseplate supplied as standard with rubber mounts to reduce vibration transmission.

Single phase version with integral thermal and over-current protection and permanent split capacitor (PSC), assembled inside the terminal box for all versions.

Motor and terminal box protection rating IPX5

Insulation class F

Ball bearings

water-proof, sealed, resistant to water and humidity. Motor construction to EN 60335-2-41 standards

Operating range

up to 184.9 GPM with pressure head of up to 72 ft

Pumped fluid clean water or water slightly contaminated with suspended particulate, long fibre; highly aggressive water with high percentage contents of chlorine/bromine and PHMB (Polyhexamethylene Biguanide) or water treated with chlorine electrolytic process

Liquid temperature range up to +140°F

Maximum ambient temperature +122°F

Maximum operating pressure 36 psi

Installation fixed or portable in horizontal position

Special versions on request

alternative voltages and/or frequencies

Reference standard IEC – 60364



TECHNICAL DATA

MODEL	CODE	ELECTRICAL DATA							MAX NOISE LEVEL dB (A)
		VOLTAGE 60 Hz	P1 MAX W	P2 NOMINAL		In A	CAPACITOR		
				KW	HP		µF	Vc	
EUROSWIM 50 M	60185775	1 x 115-230 V~	1.03	0.33	0.5	4.2	16	450	64
EUROSWIM 75 M	60185776	1 x 115-230 V~	1.23	0.5	0.75	5	20	450	65
EUROSWIM 100 M	60185777	1 x 115-230 V~	1.33	0.75	1	6.3	25	450	66
EUROSWIM 150 M	60185778	1 x 208-230 V~	1.7	1	1.5	7	31.5	450	66
EUROSWIM 200 M	60185779	1 x 208-230 V~	2.15	1.5	2	8.6	40	450	67
EUROSWIM 300 M	60185780	1 x 208-230 V~	3	2.2	3	12	-	-	67
EUROSWIM 75 T	60185781	3 x 220-277/380-480 V~	1.07	0.5	0.75	3.5 / 2	-	-	65
EUROSWIM 100 T	60185782	3 x 220-277/380-480 V~	1.3	0.75	1	4 / 2.4	-	-	66
EUROSWIM 150 T	60185783	3 x 220-277/380-480 V~	1.63	1	1.5	5 / 2.9	-	-	66
EUROSWIM 200 T	60185784	3 x 220-277/380-480 V~	1.85	1.5	2	6 / 3.5	-	-	67
EUROSWIM 300 T	60185785	3 x 220-277/380-480 V~	3	2.2	3	8.7 / 5	-	-	67

EUROSWIM

SWIMMING POOL CENTRIFUGAL PUMPS

RANGE PERFORMANCE

EUROSWIM 50

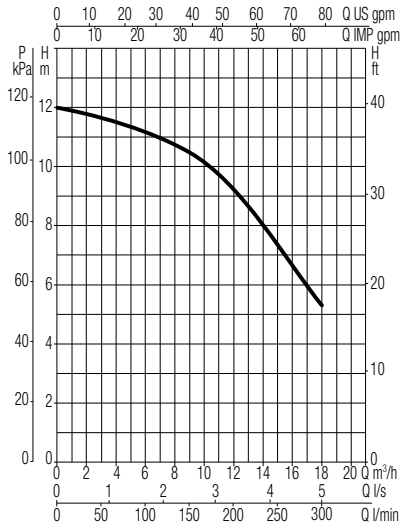

EUROSWIM 75

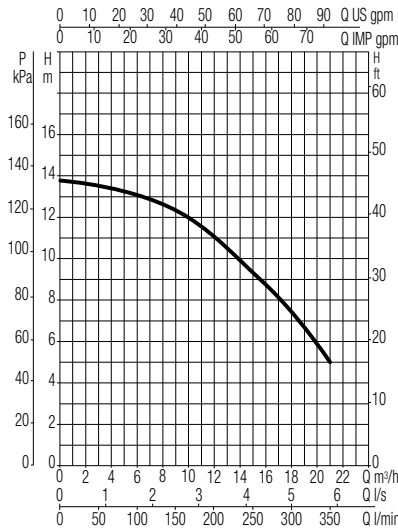

EUROSWIM 100

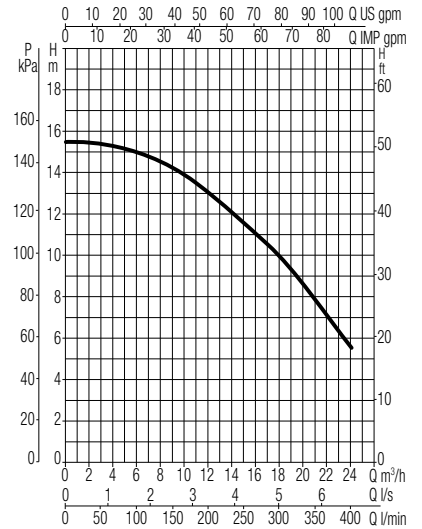

EUROSWIM 150

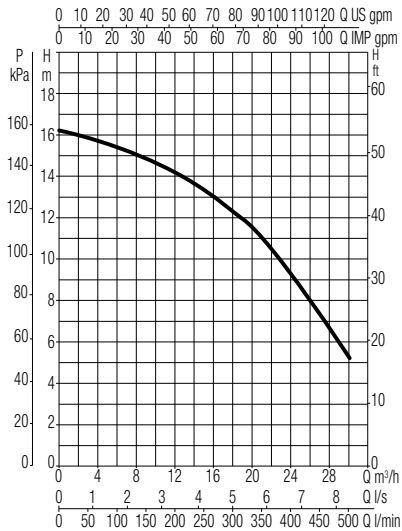

EUROSWIM 200

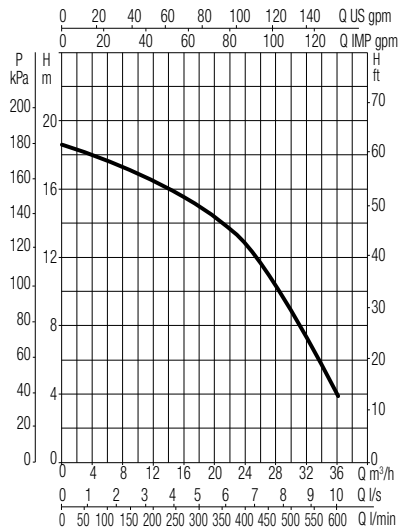

EUROSWIM 300

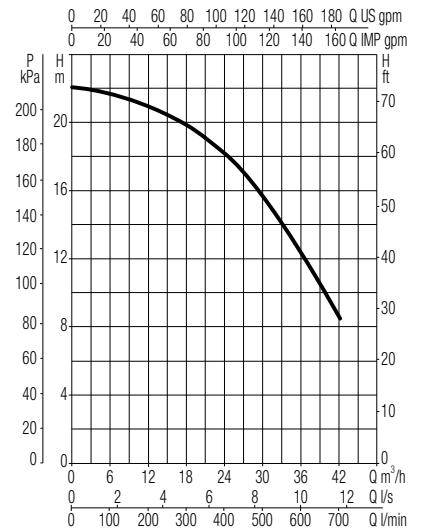

MODEL	P2 NOMINAL		Q=GPM	H (ft)											
	KW	HP		0	13.2	26.4	39.6	52.8	79.2	92.4	105.6	132	158.4	184.8	
EUROSWIM 50 M	0.33	0.5	H (ft)	39	38	37	34	31	17						
EUROSWIM 75 M - T	0.5	0.75		45	44	43	41	36	25	16					
EUROSWIM 100 M - T	0.75	1		51	51	49	47	43	33	26	18				
EUROSWIM 150 M	1.1	1.5		53	52	51	49	47	41	36	31	17			
EUROSWIM 150 T	1.1	1.5		53	51	50	48	46	41	36	31	17			
EUROSWIM 200 M - T	1.5	2		61	60	58	56	54	49	46	42	30	13		
EUROSWIM 300 M - T	2.2	3		72	72	71	70	68	64	62	59	52	41	28	

EUROSWIM

SWIMMING POOL CENTRIFUGAL PUMPS

DIMENSIONS AND WEIGHTS

EUROSWIM 50

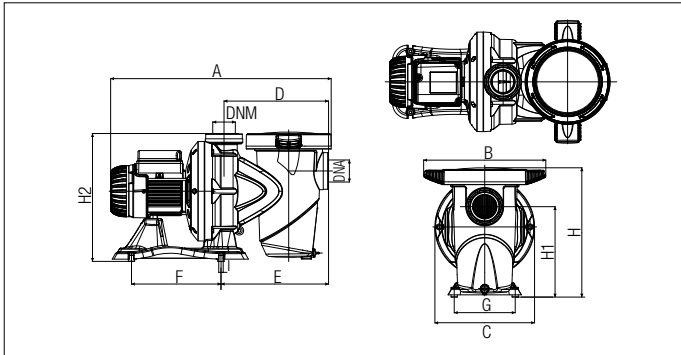

EUROSWIM 75 - 100

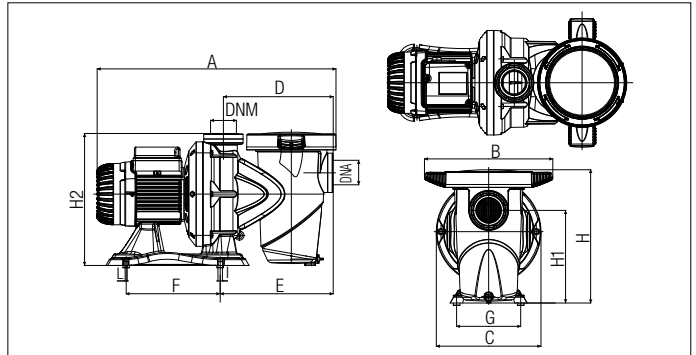

EUROSWIM 150 - 200

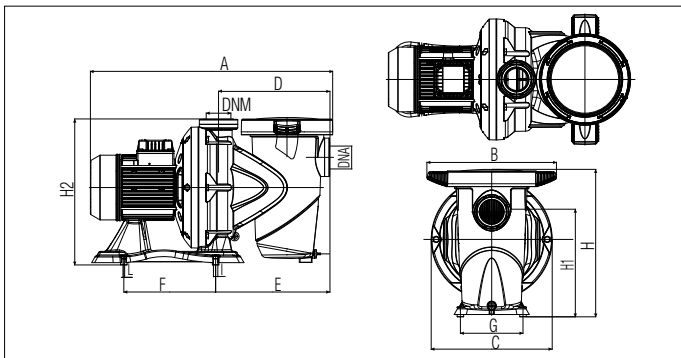

EUROSWIM 300

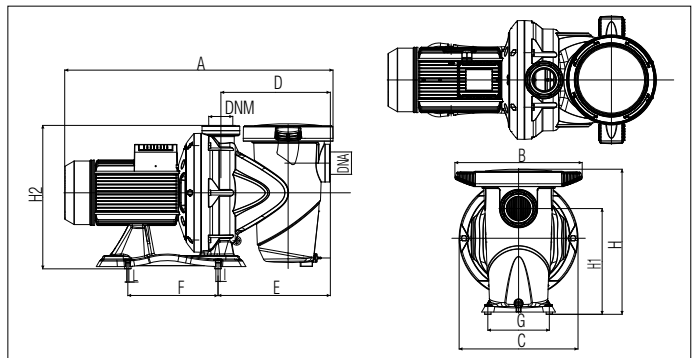

CONNECTING JUNCTIONS KIT 2"

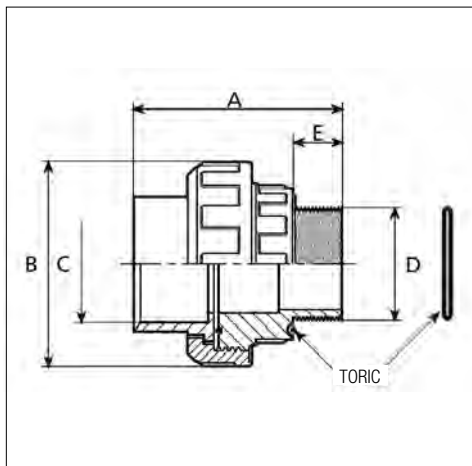

MODEL	A	B	C	D	E	F	G	H	H1	H2	I	L	DNA NPT	DNM NPT	PACKING DIMENSIONS			WEIGHT lbs	Q.TY x PALET
															L	B	H		
EUROSWIM 50 M	21.3	11.8	9.6	10.1	10.4	8.7	5.9	12.5	8.7	12.4	0.4	0.3	G2"	G2"	23.6	14.2	15.7	24.5	8
EUROSWIM 75 M - T	22	11.8	9.6	10.1	10.4	8.7	5.9	12.5	8.7	12.4	0.4	0.3	G2"	G2"	23.6	14.2	15.7	26.7	8
EUROSWIM 100 M - T	22	11.8	9.6	10.1	10.4	8.7	5.9	12.5	8.7	12.4	0.4	0.3	G2"	G2"	23.6	14.2	15.7	30.4	8
EUROSWIM 150 M	22.9	12.2	11.4	10.5	10.8	8.7	5.9	13.9	10.2	13.8	0.4	0.3	G2"	G2"	28.3	13.8	16.9	39.5	8
EUROSWIM 150 T	22.9	12.2	11.4	10.5	10.8	8.7	5.9	13.9	10.2	13.8	0.4	0.3	G2"	G2"	28.3	13.8	16.9	36.8	8
EUROSWIM 200 M	25.8	12.2	11.4	10.5	10.8	8.7	5.9	13.9	10.2	13.8	0.4	0.3	G2"	G2"	28.3	13.8	16.9	44.1	6
EUROSWIM 200 T	22.9	12.2	11.4	10.5	10.8	8.7	5.9	13.9	10.2	13.8	0.4	0.3	G2"	G2"	28.3	13.8	16.9	38.8	6
EUROSWIM 300 M - T	25.8	12.2	11.4	10.5	10.8	8.7	5.9	13.9	10.2	13.8	0.4	0.3	G2"	G2"	28.3	13.8	16.9	43.9	6
CONNECTION KIT 2"	3.9	3.9	2/2.5	2"	0.8								-	-	-	-	-	1.5	-

ACCESSORIES - CONNECTING JUNCTIONS KIT 2"

DESCRIPTION
UNIONS KIT 2" / DN 50-63
UNIONS KIT 2" / 2" - 1" 1/2

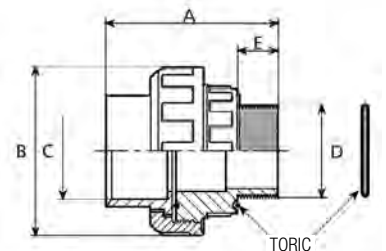

EUROCOM SP - JETCOM SP

SWIMMING POOL CENTRIFUGAL PUMPS



Self-priming centrifugal (Jetcom) or multistage (Eurocom) pump with excellent suction capability even when there are air bubbles. Suitable for use with water containing small sand impurities. Especially suitable for water supplies in domestic systems: handling of aggressive water in general with chlorine contents (swimming pools). Pump body in technopolymer.

Support and seal-carrier in AISI 316 STAINLESS STEEL.

Carbon/ceramic mechanical seal.

Rotor shaft in AISI 316 STAINLESS STEEL.

Impellers, diffuser, Venturi tube, and sand guard in technopolymer. Clearance rings in stainless steel.

Continuous duty asynchronous motor.

Built-in motor overload cut out and a capacitor permanently on in the single-phase version.

Protection for the three-phase version is the responsibility of the user.

Motor protection level IP 44

Terminals protection level IP 55

Insulation class F

Operating range from 2.6 to 21.1 GPM with head of up to 190 ft depending on the model

Liquid quality requirements clean, free of solid or abrasive contaminants, swimming pool water (containing chlorine)

Liquid temperature range

from 32°F to +95°F for domestic use

(EN 60335-2-41)

from 32°F to +104°F for other uses

Maximum ambient temperature +104°F

Maximum operating pressure 87 psi

Installation fixed or portable in horizontal position

TECHNICAL DATA

MODEL	CODE	ELECTRICAL DATA						
		VOLTAGE 60 Hz	P1 MAX kW	P2 NOMINAL		In A	CAPACITOR	
				kW	HP		µF	Vc
EUROCOM SP 40/506 M	60193516	1x115/230 V~	1.2	0.75	1	10.3 - 5	80	250
JETCOM SP 102 M	60193515	1x115/230 V~	1.1	0.75	1	9.7 - 5	50	250

RANGE PERFORMANCE

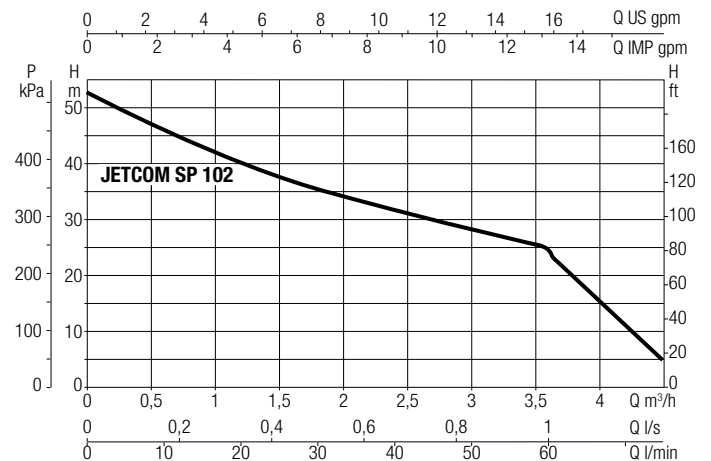
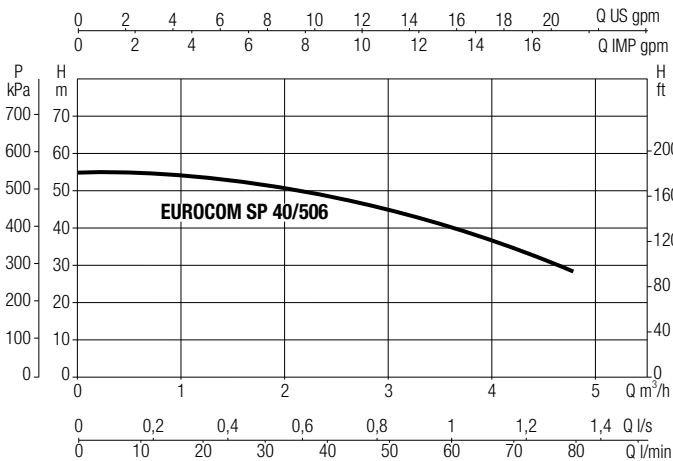

MODEL	P2 NOMINAL		Q=GPM	Q (ft)											
	0.75	1		0	2.6	5.3	7.9	10.6	13.2	15.8	18.5	21.1	26.4		
EUROCOM SP 40/506 M	0.75	1	H	170	167	166	161	151	138	120	95	75	19		
JETCOM SP 102 M	0.75	1	(ft)	144	122	105	93	83	71	62	33	5			

EUROCOM SP - JETCOM SP

SWIMMING POOL CENTRIFUGAL PUMPS

DIMENSIONS AND WEIGHTS

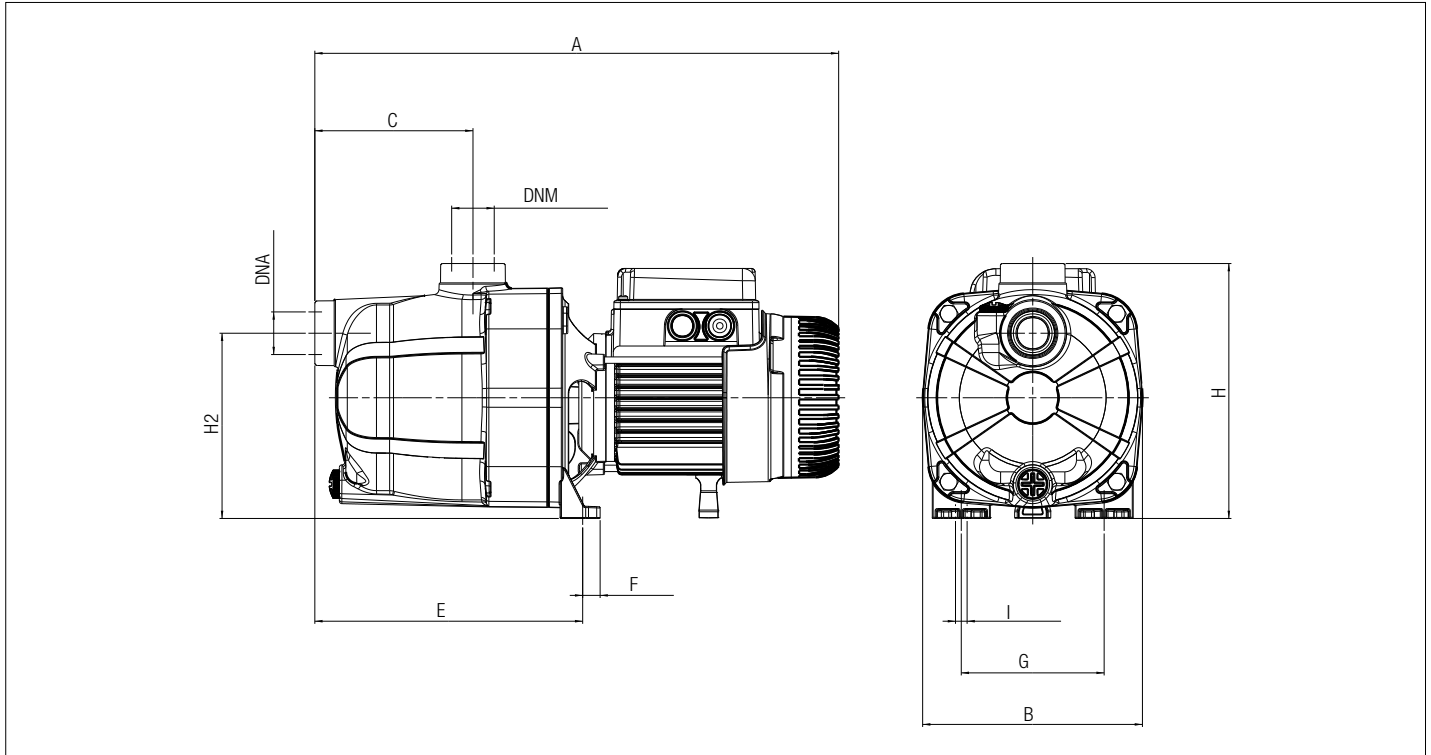

MODEL	A	B	C	E	F	G	IØ (4 Holes)	H	H1	DNA NPT	DNM NPT	PACKING DIMENSIONS			WEIGHT lbs	Q.TY x PALLET
												L/A	L/B	H		
EUROCOM SP 40/50	16.7	6.7	4.8	8.2	0.6	4.4	0.4	8	5.7	1"	1"	18.5	9.4	9.4	24.9	28
JETCOM SP 102	16.7	6.7	4.8	8.2	0.6	4.4	0.4	8	5.7	1"	1"	18.5	9.4	9.4	20.9	28

ACCESSORIES SWIMMING POOL

ACCESSORIES

SWIMMING POOL

E.SWIM ACCESSORIES	DESCRIPTION	CODE
	CONNECTION CABLE 52 FT KIT 12 PIN	60194430



On-line product selection

 **DAB PUMPS LTD.**
6 Gilbert Court
Newcomen Way
Severalls Business Park
Colchester
Essex
CO4 9WN - UK
salesuk@dwtgroup.com
Tel. +44 0333 777 5010

 **DAB PUMPS IBERICA S.L.**
Calle Verano 18-20-22
28850 - Torrejón de Ardoz - Madrid
Spain
Info.spain@dwtgroup.com
Tel. +34 91 6569545
Fax: + 34 91 6569676

 **DAB PUMPS SOUTH AFRICA (PTY) LTD**
Twenty One industrial Estate,
16 Purlin Street, Unit B, Warehouse 4
Olifantsfontein -1666 - South Africa
info.sa@dwtgroup.com
Tel. +27 12 361 3997

 **DAB PUMPS BV**
"Hofveld 6 C1
1702 Groot Bijgaarden - Belgium
info.belgium@dwtgroup.com
Tel. +32 2 4668353

 **DAB PUMPS HUNGARY KFT.**
H-8800
Nagykanizsa, Buda Ernő u.5
Hungary
Tel. +36 93501700

 **DAB PUMPS (QINGDAO) CO. LTD.**
No.40 Kaituo Road, Qingdao Economic & Technological
Development Zone
Qingdao City, Shandong Province - China
PC: 266500
sales.cn@dwtgroup.com
Tel. +86 400 186 8280
Fax +86 53286812210

 **DAB PUMPS B.V.**
Albert Einsteinweg, 4
5151 DL Drunen - Nederland
info.netherlands@dwtgroup.com
Tel. +31 416 387280
Fax +31 416 387299

 **DAB PUMPS POLAND Sp. z o.o.**
Ul. Janka Muzykanta 60
02-188 Warszawa - Poland
polska@dabpumps.com.pl

 **DAB PUMPS DE MÉXICO, S.A. DE C.V.**
Av Amsterdam 101 Local 4
Col. Hipódromo Condesa,
Del. Cuauhtémoc CP 06170
Ciudad de México
Tel. +52 55 6719 0493

 **DAB PUMPS GMBH**
Am Nordpark 3
D - 41069 Mönchengladbach - Germany
info.germany@dwtgroup.com
Tel. +49 2161 47388-0
Fax +49 2161 47388-36

 **OOO DAB PUMPS**
Novgorodskaya str. 1, block G
office 308, 127247, Moscow - Russia
info.russia@dwtgroup.com
Tel. +7 495 122 0035
Fax +7 495 122 0036

 **DAB PUMPS OCEANIA PTY LTD**
426 South Gippsland Hwy,
Dandenong South VIC 3175 - Australia
info.oceania@dwtgroup.com
Tel. +61 1300 373 677

 **DAB PUMPS INC.**
3226 Benchmark Drive
Ladson, SC 29456 - USA
info.usa@dwtgroup.com
Tel. 1- 843-797-5002
Fax 1-843-797-3366

 **PT DAB PUMPS INDONESIA**
Satrio Tower lantai 26
unit C-D, Jl. Prof. Dr. Satrio Kav. C4,
Kel. Kuningan Timur, Kec. Setiabudi, Kota Adm.
Jakarta Selatan, Prov. DKI Jakarta. - Indonesia
Tel. +62 2129222850



Via Marco Polo, 14
35035 Mestrino (PD) Italy
Tel. +39.049.5125000 - Fax +39.049.5125950
www.dabpumps.com



DAB Pumps Inc.
3226 Benchmark Drive
Ladson, SC 29456 - USA
info.usa@dwtgroup.com
Tel. 1-843-797-5002 - Fax 1-843-797-3366
www.dabpumps.us