



Technical Data

Thermal Oil Pump - TKF-K 100-200

Revision no.

Page:
1

Receiver

From

Company name
Respons. Department
Person in charge
Phone number
Fax no
E-mail address



Brand: Gol Pumps
Model: TKF-K 100-200

Weight (lb)
178

Dimensions:

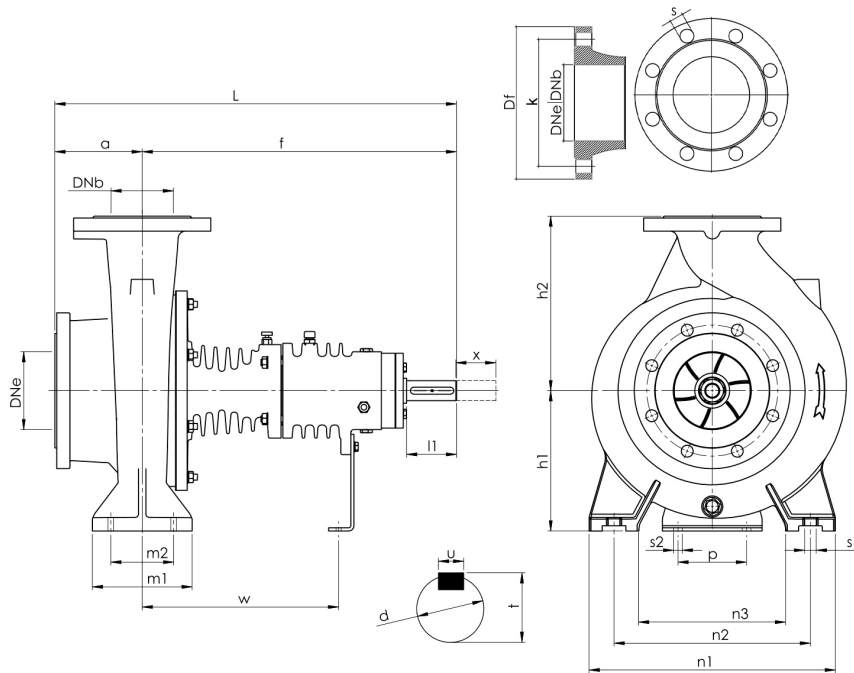

Inlet and Outlet PN16 (inch)					
DNe	DNb	Df	k	s	n
5	4	9	7	0.7	8

Shaft Dimensions (inch)			
d	l1	t	u
1	3	1	0.4

TS EN 1092-2 * n: Number of holes

Pump Installation Size (inch)															
Outside						Supporting Foot									Spacing
a	f	L	H	h1	h2	m1	m2	n1	n2	n3	s1	p	s2	w	x
5	20	25	19	8	11	6	5	14	11	8	0.7	4	0.6	12	6

* x: Minimum distance between motor and pump shafts to remove rotor from rear.

Project	Project ID	Created by	Created on	Last update
---------	------------	------------	------------	-------------



Performance Curves

Thermal Oil Pump - TKF-K 100-200

Revision no.

Page:
2

Receiver

From

Company name
Respons. Department
Person in charge
Phone number
Fax no
E-mail address

TKF 100-200 (3600RPM)

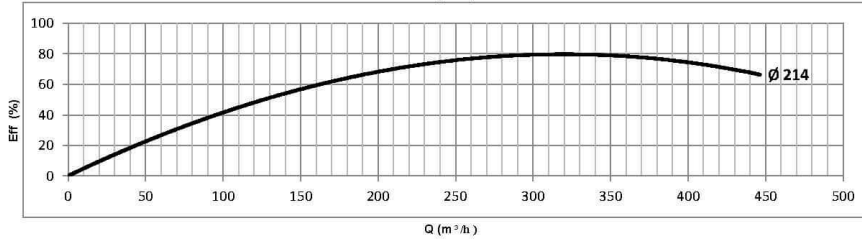
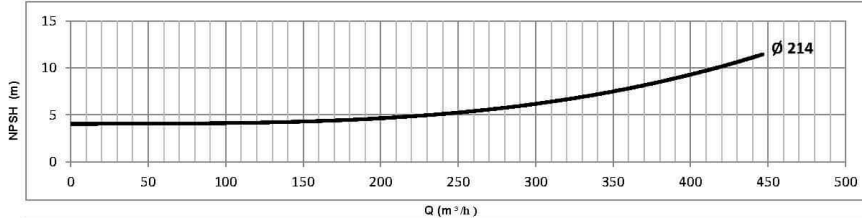
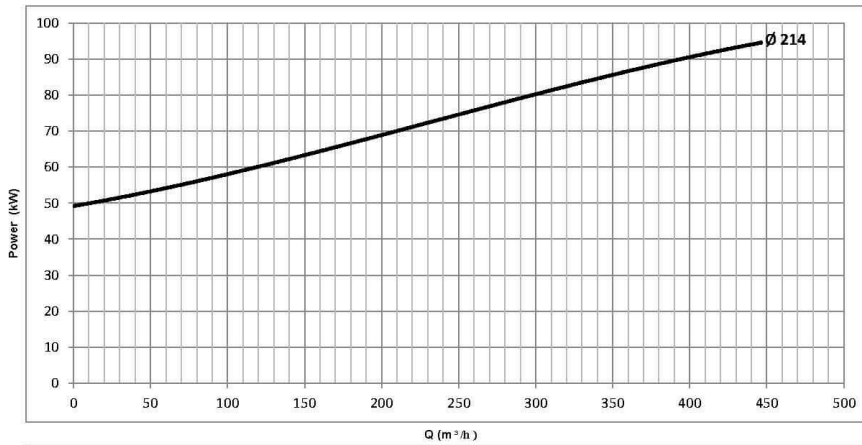
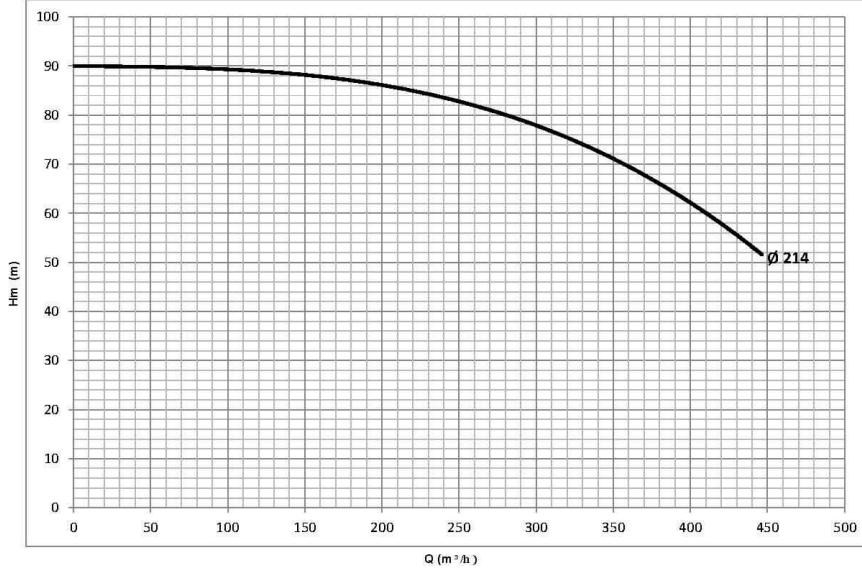

Project	Project ID	Created by	Created on	Last update
---------	------------	------------	------------	-------------



Parts List

Thermal Oil Pump - TKF-K 100-200

Revision no.

Page:

3

Receiver

From

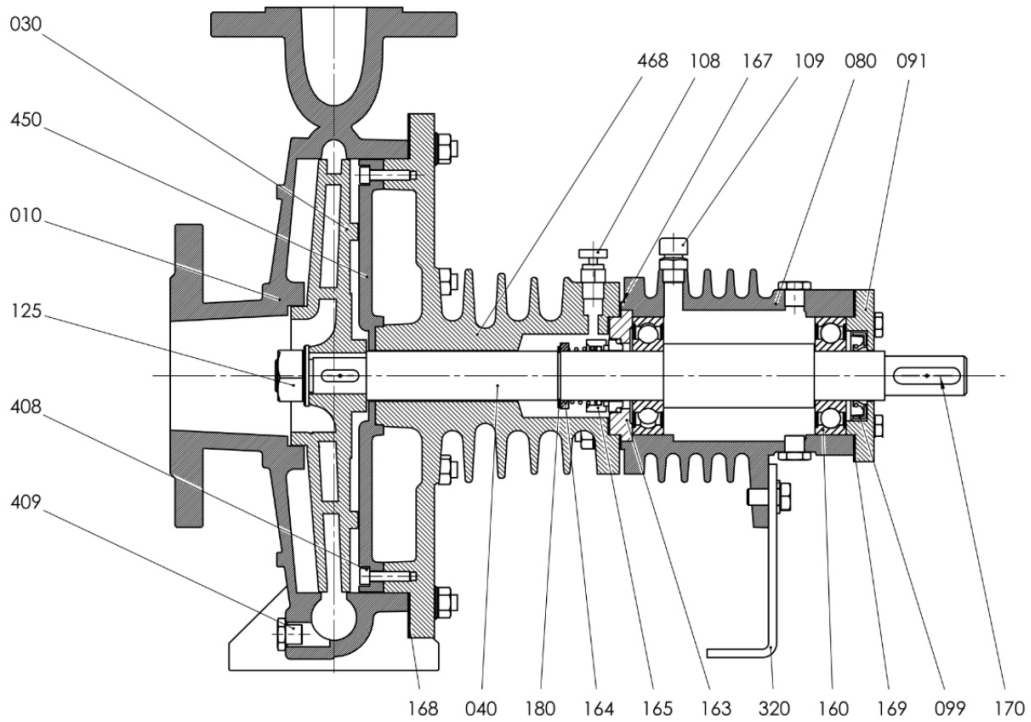
 Company name
 Respons. Department
 Person in charge
 Phone number
 Fax no
 E-mail address

Volute Casing	010
Impeller	030
Shaft	040
Bearing Housing	080
Bearing Cover	091
Oil Seal	099
Air Purge	108
Air Plug	109
Nut	125
Bearing	160
Mechanical Seal Cover	163
Mechanical Seal Setting Sleeve	164

Mechanical Seal	165
Mechanical Seal Gasket	167
Body Seal	168
Bearing Cover Gasket	169
Key	170
Shaft Ring	180
Supporting Feet	320
Bolt	408
Drain Plug	409
Wear Plate	450
Casing Cover	468

Project

Project ID

Created by

Created on

Last update