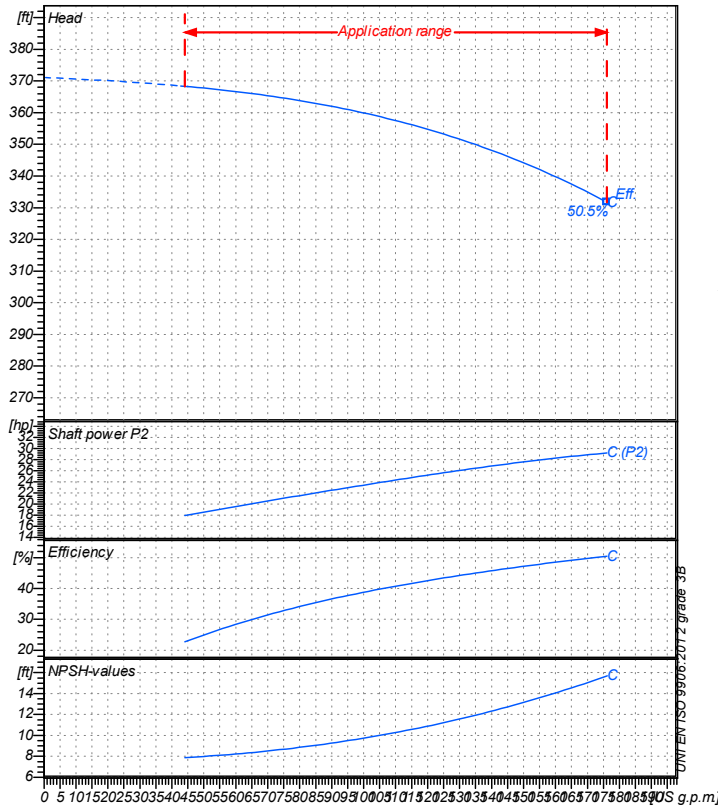

Receiver

From

 Company name
 Respons. Department
 Person in charge
 Phone number
 Fax no
 E-mail address

Operating data specification

Nominal flow	US g.p.m.	0
Nominal head	ft	0
Static head	ft	0
NPSH - value of plant	ft	0
Inlet pressure	psi	1.42
Fluid	Water, pure	
Operating temperature t A	°F	68
Density at t A	lb/ft³	62.32
Kin. viscosity at t A	ft²/s	1.082E-5

Pump

Pump name	6IR32-250C		
Size	50/32/250		
Design			
Speed rpm	3600	No of stages	1
Impeller type			
Flow	Nominal	US g.p.m.	
	Max-	US g.p.m.	176
	Min-	US g.p.m.	44
Head	Nominal	ft	
	Max-	ft	368
	Min-	ft	332
Head H(Q=0)	ft		371
NPSH 3%	ft		
Max. working pressure	psi		161
Shaft power	hp		
Efficiency	%		
Max absorbed power	hp		29.203

Materials Pump

Shaft	Stainless steel AISI 431 (1.4057)
Impeller	Cast iron EN-GJL-250
Pump body	Cast iron EN-GJL-250
Seal disc	Cast iron EN-GJL-250
Gasket	Natural fiber
Mechanical seal	BVEG (Grafite/Ossido Allumina/EPDM)

Dimensions in inch

a	3 ¹⁵ / ₁₆
b	2 ⁹ / ₁₆
DNA	1 ¹⁵ / ₁₆
DNM	1 ¹ / ₄
f	25 ⁹ / ₁₆
h1	7 ¹ / ₁₆
h2	8 ⁷ / ₈
m1	4 ¹⁵ / ₁₆
m2	3 ³ / ₄
n1	12 ⁵ / ₈
n2	9 ¹³ / ₁₆
s	9 ⁹ / ₁₆
w	5 ³ / ₈

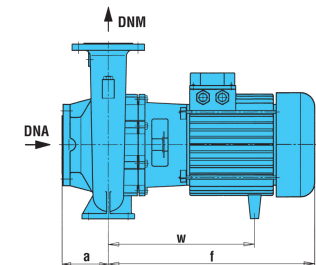
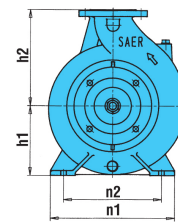
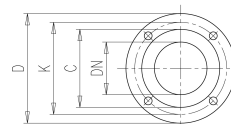

?n	3/4	?n	3/4
C	3 ¹ / ₁₆	C	4
D	5 ¹ / ₂	D	6 ¹ / ₂
DN	1 ¹ / ₄	DN	1 ¹⁵ / ₁₆
K	3 ¹⁵ / ₁₆	K	4 ¹⁵ / ₁₆
n°	3/16	n°	3/16

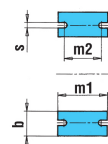

Motor	Frame size	160 L		
Manufacturer / Type	SAER	MEC160L-2P-22		
Rated power	hp	29.502	Efficiency 4/4	86 %
Electric current	A	72 A	Speed rpm	3600
Electric voltage	V	230V	3~	Hz 60
Starting mode	Unknown			
Degree of protection	IP 55	Insulation class	F	

Remarks:

Project	Project ID	Created by	Created on	Last update
			2020/07/16	

Receiver	From
Company name	
Respons. Department	
Person in charge	
Phone number	
Fax no	
E-mail address	

Operating area	Flow	Head	Impeller type
Operating data specification	0 US g.p.m	0 ft	Impeller construction Closed
Pump data	US g.p.m	ft	Sense of rotation Clockwise from the drive end
			Outlet width DN 32
	Shaft power P2		Speed rpm 3600
	Min. Max. η Max.	H(Q=0) η Max.	Frequency Hz 60 Hz
	US g.p.m US g.p.m US g.p.m	ft ft	
	44 176 176	371 332	
		P2(Q=0) Max. η Max.	
		hp hp hp	
		29.2 29.2	

Performance data based to: Water, pure [100%]; 68°F; 62.3lb/ft³; 1.08E-5ft²/s UNI EN ISO 9906:2012 - Grade 3B

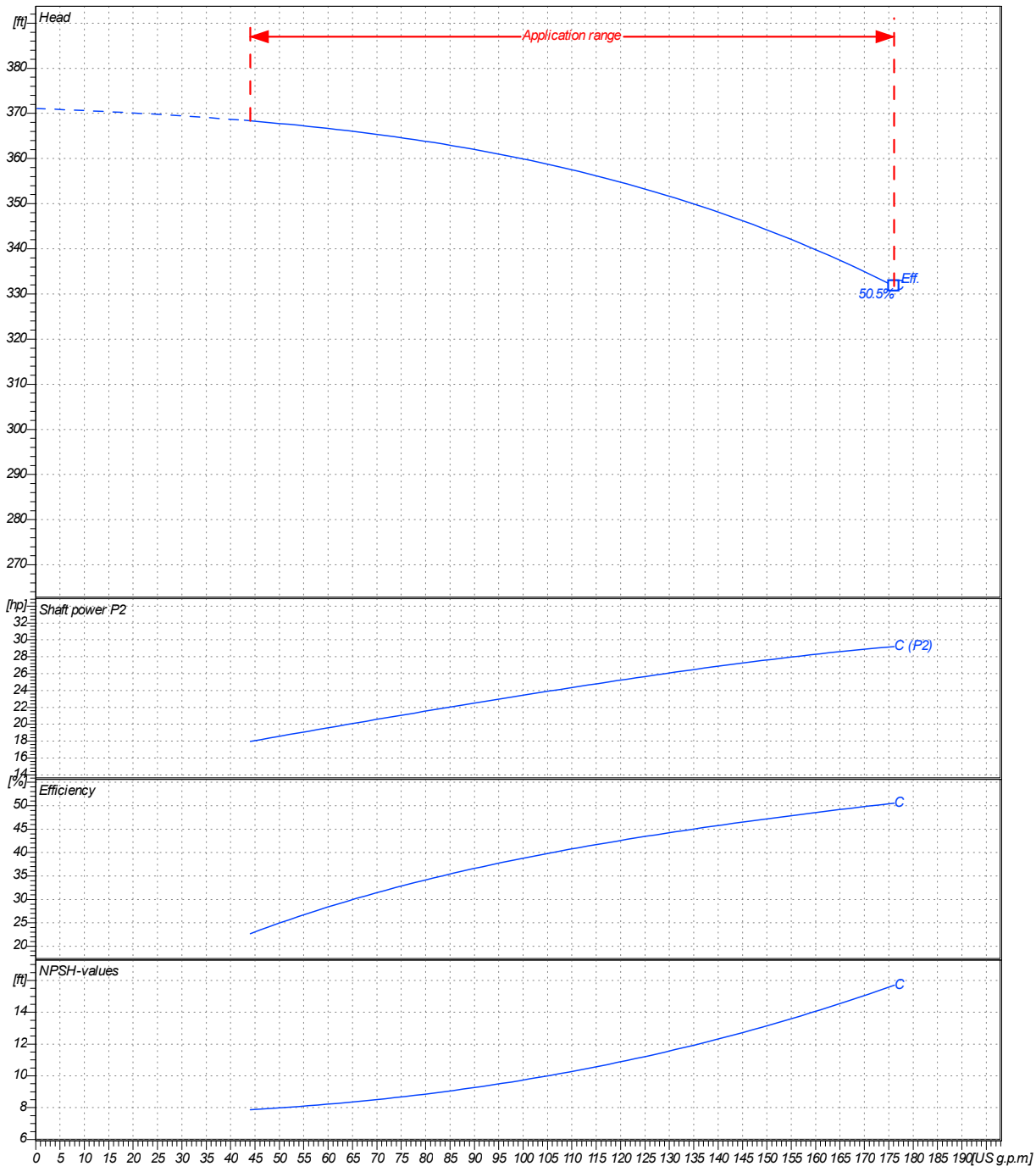

Project	Project ID	Created by	Created on 2020/07/16	Last update
---------	------------	------------	---------------------------------	-------------

Company name
Respons. Department
Person in charge
Phone number
Fax no
E-mail address

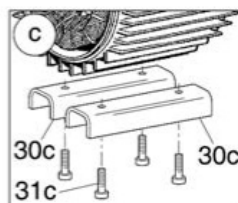
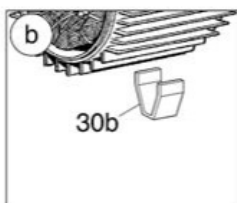
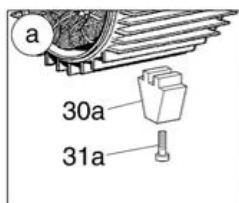
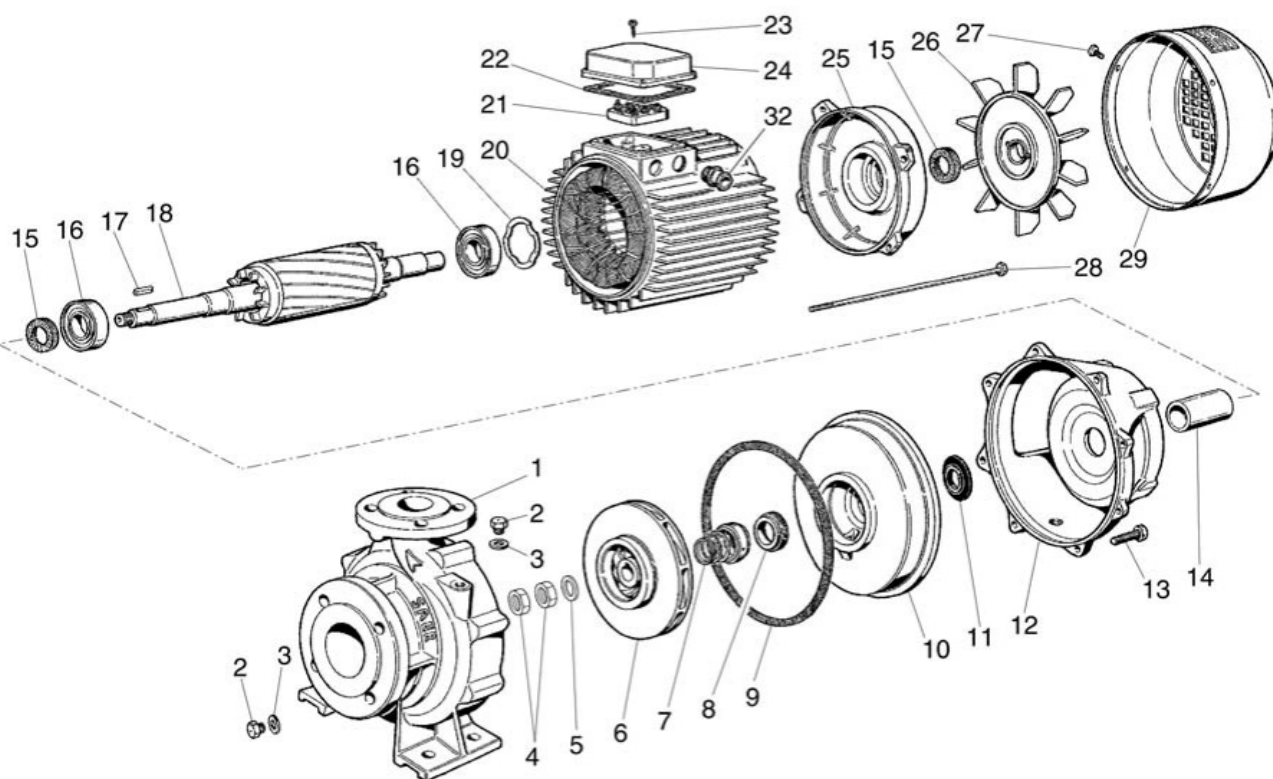

Project

Project ID

Created by

Created on
2020/07/16

Last update