

Receiver	From
Company name	
Respons. Department	
Person in charge	
Phone number	
Fax no	
E-mail address	

Operating area	Flow	Head	Impeller type
Operating data specification	0 US g.p.m	0 ft	Impeller construction
Pump data	US g.p.m	ft	Sense of rotation
			Clockwise from the drive end
			Outlet width
			DN 40
	Flow	Head	Shaft power P2
	Min. Max. η Max.	H(Q=0) η Max.	P2(Q=0) Max. η Max.
	US g.p.m US g.p.m US g.p.m	ft ft	hp hp hp
	52.8 242 158	128 106	7.1 6.07
			Speed rpm 3600
			Frequency Hz 60 Hz

Performance data based to: Water, pure [100%]; 68°F; 62.3lb/ft³; 1.08E-5ft²/s UNI EN ISO 9906:2012 - Grade 3B

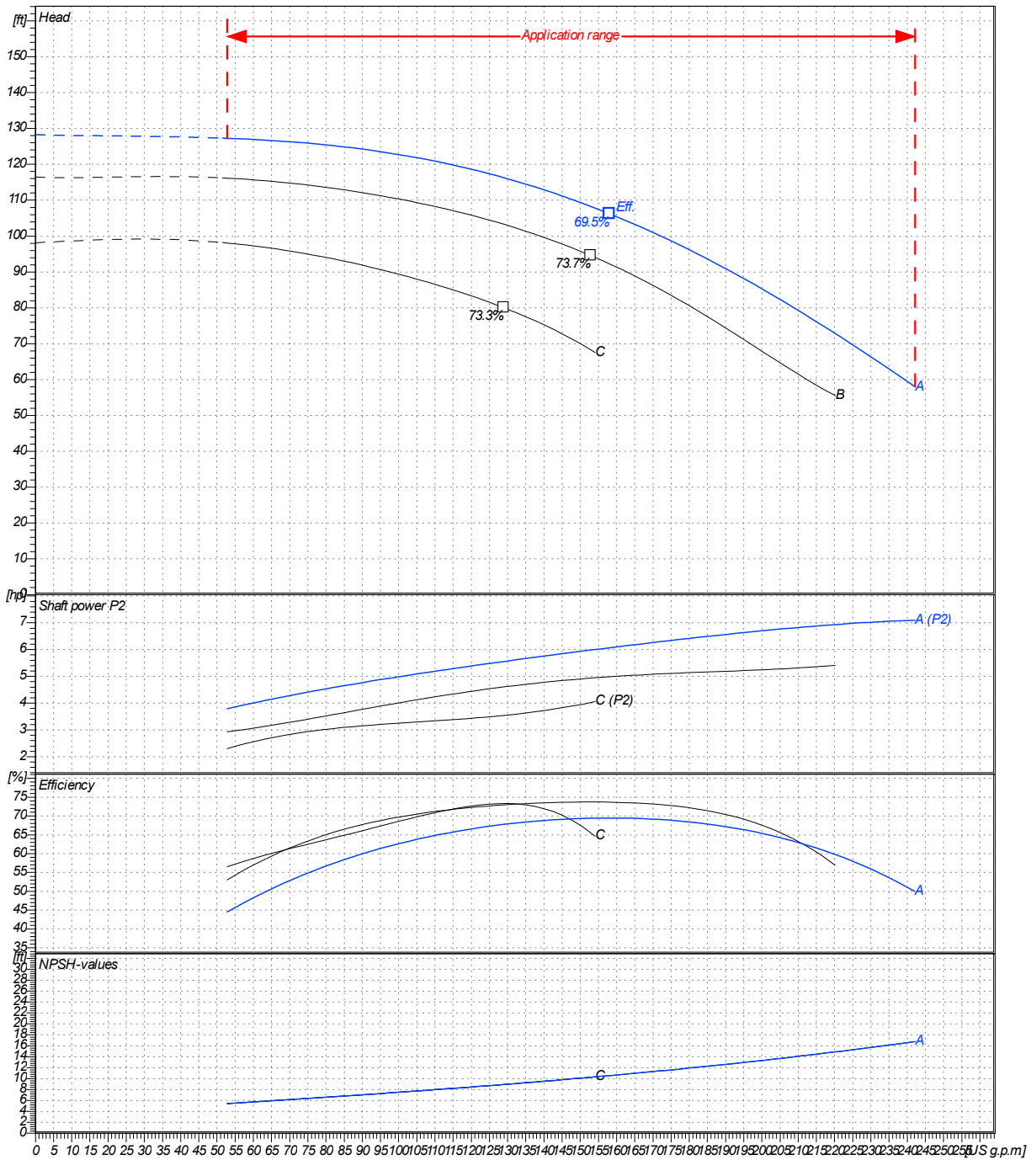

Project	Project ID	Created by	Created on	Last update
			2020/07/16	

Company name
Respons. Department
Person in charge
Phone number
Fax no
E-mail address

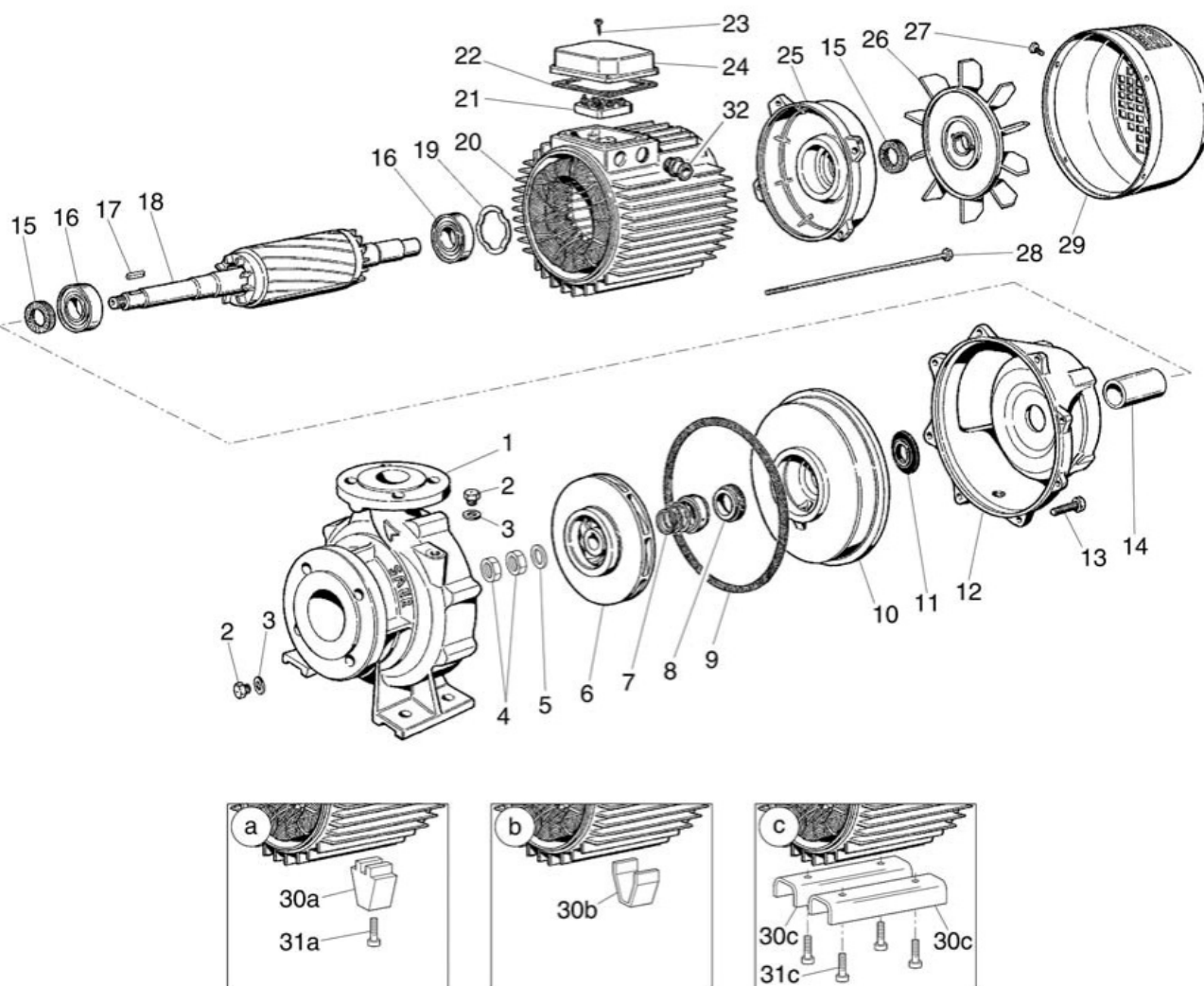

Project

Project ID

Created by

Created on
2020/07/16

Last update