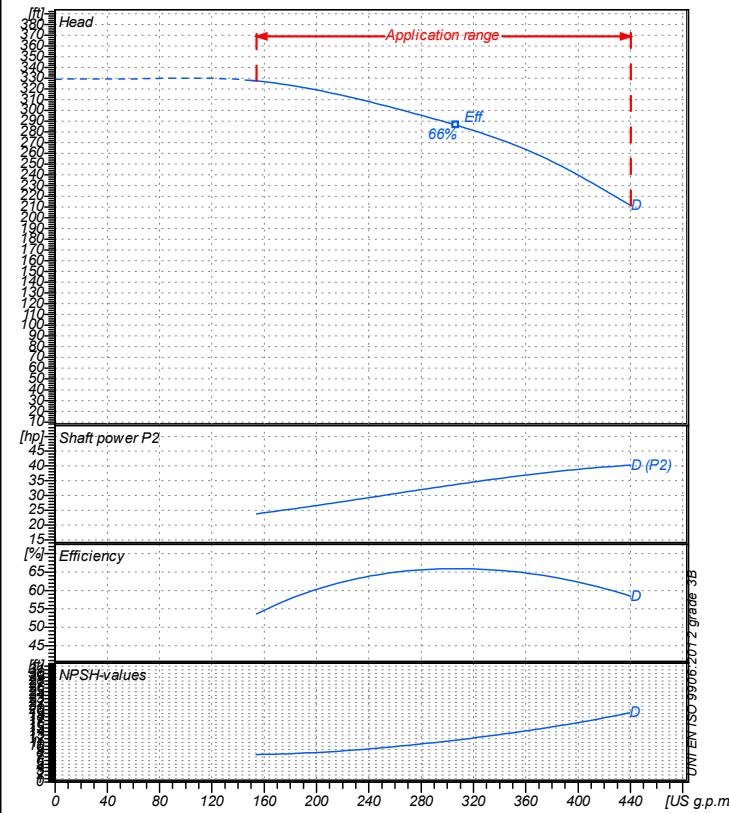

Receiver

From

 Company name
 Respons. Department
 Person in charge
 Phone number
 Fax no
 E-mail address

Operating data specification

Nominal flow	US g.p.m	0
Nominal head	ft	0
Static head	ft	0
NPSH - value of plant	ft	0
Inlet pressure	psi	1.42
Fluid	Water, pure	
Operating temperature t A	°F	68
Density at t A	lb/ft³	62.32
Kin. viscosity at t A	ft²/s	1.082E-5

Pump

Pump name	6IR50-250ND		
Size	65/50/250		
Design			
Speed rpm	3600	No of stages	1
Impeller type			
Flow	Nominal	US g.p.m	
	Max-	US g.p.m	440
	Min-	US g.p.m	154
Head	Nominal	ft	
	Max-	ft	328
	Min-	ft	212
Head H(Q=0)	ft 329		
NPSH 3%	ft		
Max. working pressure	psi 142		
Shaft power	hp		
Efficiency	%		
Max absorbed power	hp 40.269		

Materials Pump

Shaft	Stainless steel AISI 431 (1.4057)
Impeller	Cast iron EN-GJL-250
Pump body	Cast iron EN-GJL-250
Seal disc	Cast iron EN-GJL-250
Gasket	Natural fiber
Mechanical seal	BVEG (Grafite/Ossido Allumina/EPDM)

Dimensions in inch

a	3 ¹⁵ / ₁₆	z1	13 ⁹ / ₁₆
b	2 ⁹ / ₁₆	z2	11
d	9 ¹ / ₁₆		
DNA	2 ⁹ / ₁₆		
DNM	1 ¹⁵ / ₁₆		
f	28 ⁹ / ₁₆		
h1	7 ¹ / ₁₆		
h2	8 ⁷ / ₈		
m1	4 ¹⁵ / ₁₆		
m2	3 ³ / ₄		
n1	12 ⁵ / ₈		
n2	9 ¹³ / ₁₆		
s	9 ¹ / ₁₆		
w	10 ¹ / ₄		
x1	16 ¹ / ₈		
x2	14 ⁹ / ₁₆		

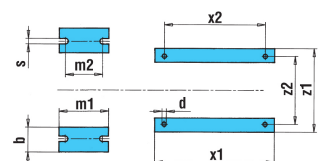
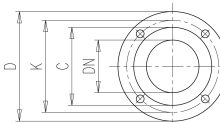
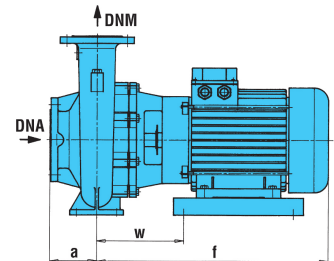
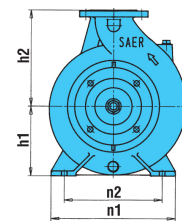

Motor	Frame size	180 L		
Manufacturer / Type	SAER	MEC180L-2P-30		
Rated power	hp	40.231	Efficiency 4/4	88 %
Electric current	A	48.9 A	Speed rpm	3600
Electric voltage	V	460V	3~	Hz 60
Starting mode	Unknown			
Degree of protection	IP 55	Insulation class	F	

Remarks:

Project	Project ID	Created by	Created on	Last update
			2020/07/16	

Receiver	From
Company name	
Respons. Department	
Person in charge	
Phone number	
Fax no	
E-mail address	

Operating area	Flow	Head	Impeller type
Operating data specification	0 US g.p.m	0 ft	Impeller construction
			Closed
			Sense of rotation
			Clockwise from the drive end
Pump data	US g.p.m	ft	Outlet width
			DN 50
	Flow	Head	Shaft power P2
	Min. Max. η Max.	H(Q=0) η Max.	P2(Q=0) Max. η Max.
	US g.p.m US g.p.m US g.p.m	ft ft	hp hp hp
	154 440 307	329 286	40.3 33.7
			Speed rpm 3600
			Frequency Hz 60 Hz

Performance data based to: Water, pure [100%]; 68°F; 62.3lb/ft³; 1.08E-5ft²/s

UNI EN ISO 9906:2012 - Grade 3B

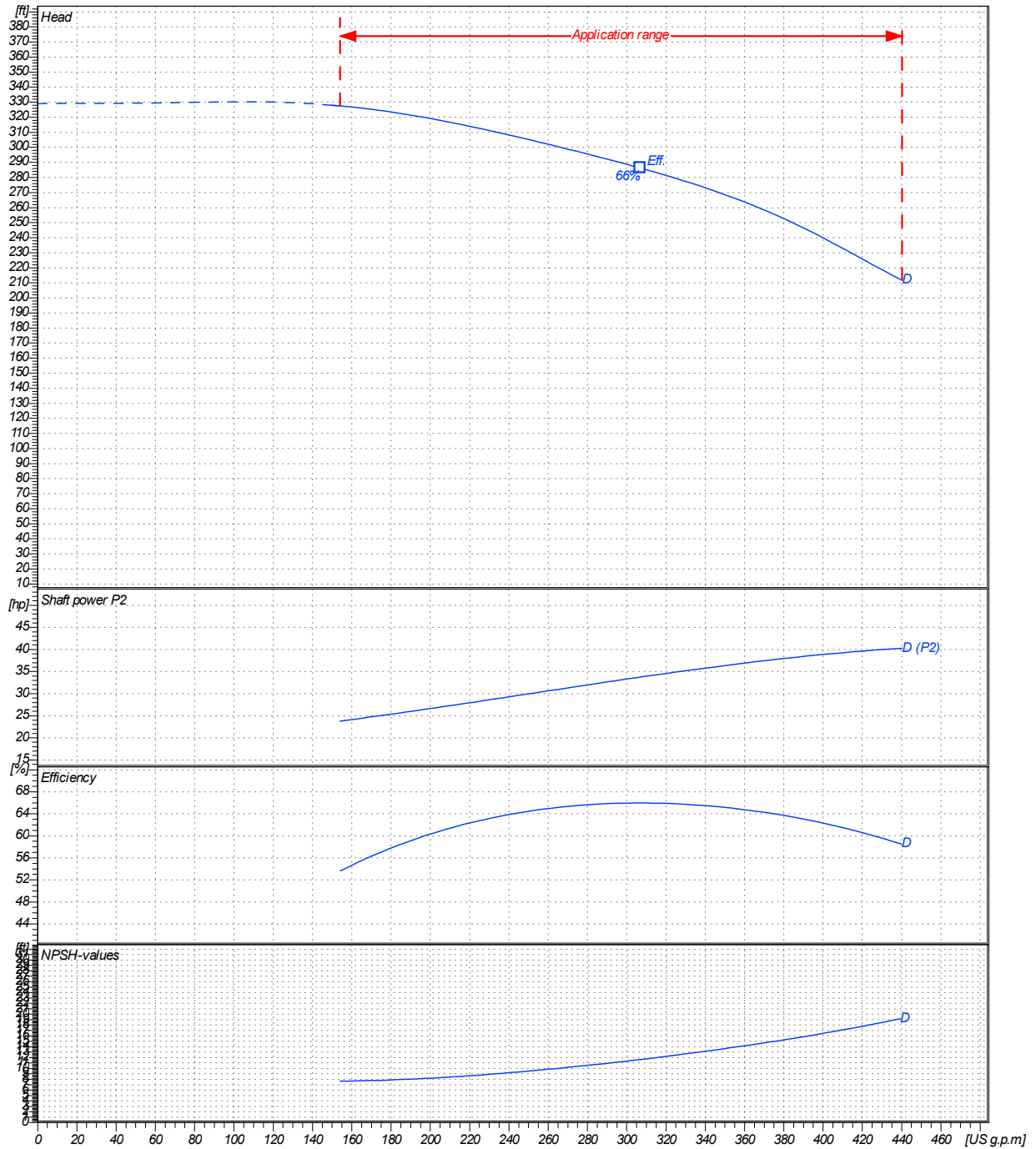

Project	Project ID	Created by	Created on	Last update
			2020/07/16	

Company name
Respons. Department
Person in charge
Phone number
Fax no
E-mail address

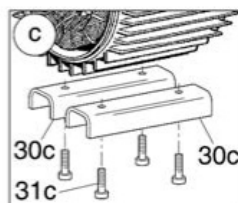
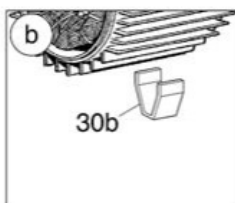
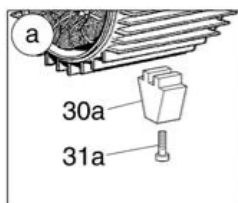
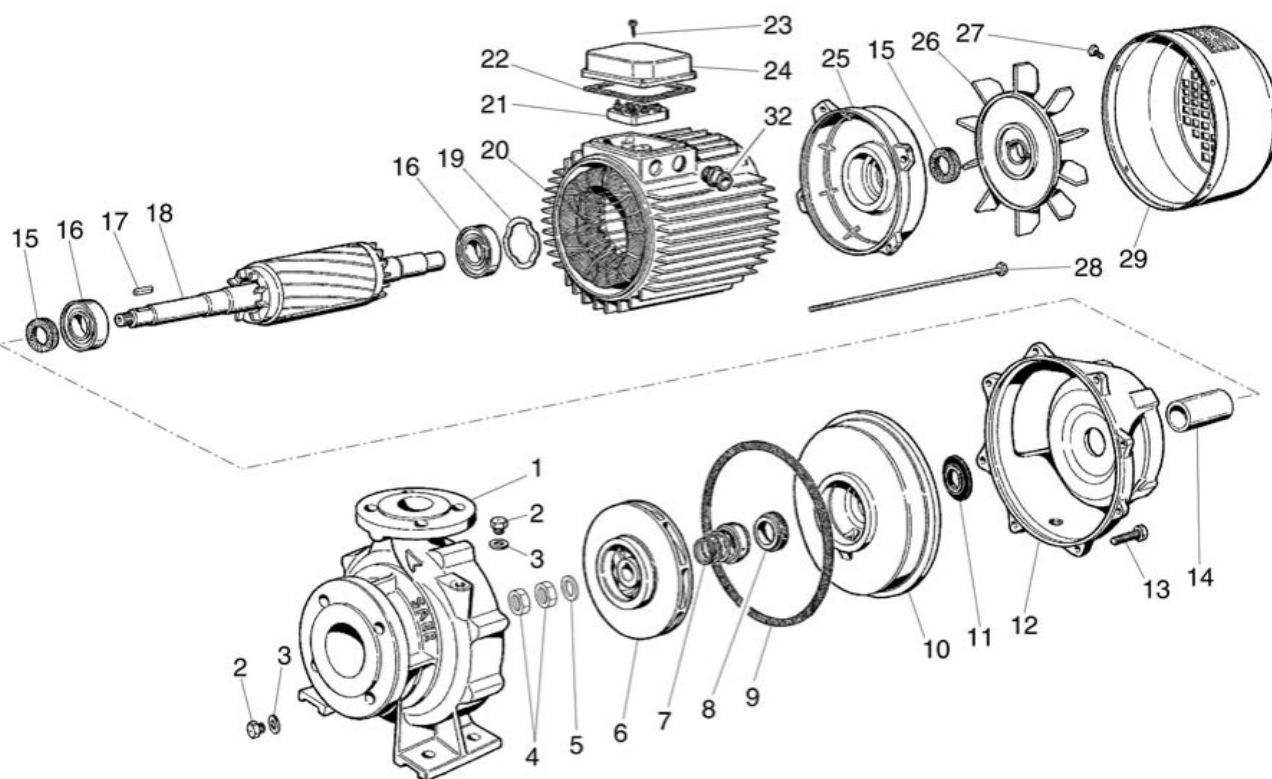

Project

Project ID

Created by

Created on
2020/07/16

Last update